



## QUICK TS1200D

### Lead Free Soldering Station

### Instruction Manual

QUICK INTELLIGENT EQUIPMENT CO., LTD.  
ADD: NO.11, FengXiang Road, Wujin High-Tech Industrial  
Development Zone, Jiangsu, China  
TEL: 86-519-86225678  
FAX: 86-519-86558599  
POSTCODE: 213167  
WEBSITE: [www.quick-global.com](http://www.quick-global.com)

Thank you for purchasing our Lead Free Soldering Station. It is designed for lead free soldering. Please read this manual before operating the unit. Store this manual in a safe, easily accessible place for future reference.

## XI、Solder Tip

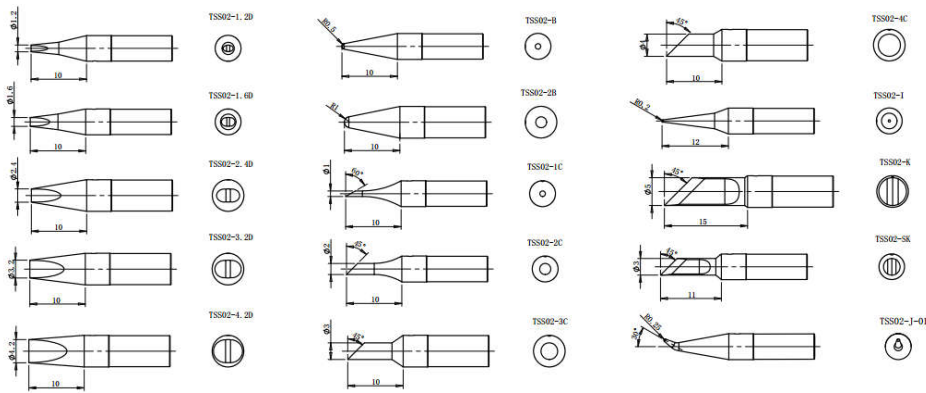

## I . Safety Instruction

### ⚠ CAUTION

When the power is on, the tip's temperature is very high. The mishandling may lead to burns or fire, be sure to comply with the following precautions:

- Please avoid an abuse of the unit and use the appliance only as the described manner.
- Do not touch the metallic parts near the tip.
- Do not use the product near flammable items.
- Advise other people in the work area that the unit can reach a very high temperature and should be considered potentially dangerous.
- While replace parts or install tips, turn the power off and allow the unit to cool to room temperature.

To prevent damage to the unit and ensure a safe working environment, be sure to comply with the following precautions:

- Appliance shall only be used with rated voltage and frequency. (Refer to the trademark back of equipment.)
- Don't use the appliance if it is damaged, especially the supply cord.
- This machine is equipped with a 3-wires grounding plug and must be plugged into a 3-terminal grounded socket. Do not modify plug or use an ungrounded power socket. If an extension cord is necessary, use only a 3-wire extension cord that provides grounding.
- Do not use the unit for other applications except soldering.
- Only use genuine replacement parts.
- Do not wet the unit. When your hands are wet, don't use and disconnect the unit, or to pull the supply cord.
- The soldering process will produce smoke, so make sure the area is well ventilated.
- While using the unit, don't do anything which may cause bodily harm or physical damage.

## II. Summary

The soldering station's temperature adopts LCD double temperature display and digital calibration, shortcut and convenience. The temperature induction is very exact and sensitive, the speed of heating and recovery of temperature is very fast, and so it is the one of the most perfect tools for lead free soldering.

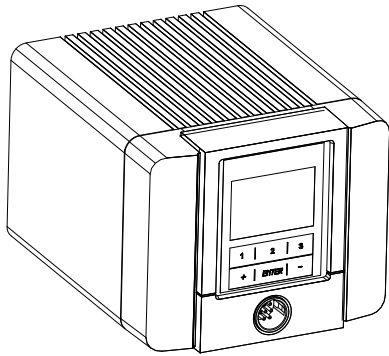

## III. Feature

1. Can preset technological parameter of three channels, more practical.
2. Temperature alarm function, temperature changer.
3. Sensor preposition, real-time monitor temperature of tin, return temperature rapidly.
4. Solder tip change convenience.
5. Anti-static device, ESD measuring ability.

- (6) Extend tip life by switch the system off when not in use.
- (7) Don't apply pressure to the tip. More pressure does not equal more heat. To improve heat transfer, use solder to form a thermal bridge between the tip and the solder joint.

## IX. Tip Care and Maintenance

### Select a Correct Tip

1. Select a tip that maximizes contact area between the tip and solder joint. Maximizing contact area gives the most efficient heat transfer, allowing operators to produce high quality solder joints quickly.
2. Select a tip that allows good access to the solder joint. Shorter tip lengths allow more precise control. Longer or angled may be needed for soldering densely populated boards.

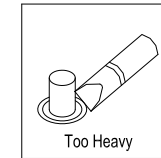
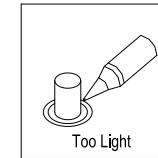
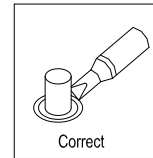

## X. Error Messages

Various error messages will be displayed when there is something wrong with the unit.

- “Sensor broken”: Sensor opens away.
- “Handle type”: Handle type wrong.
- “NO handle ”: Handle is not inserted.
- “sensor shorten”: Sensor short circuit
- “Heater shorten”: Heating element short circuit

## 2. Why a “de-tinned” tip fails to work?

A de-tinned tip is one which cannot wet with solder. This exposes the plating to oxidation and degrades the heat transfer efficiency of the tip.

The de-tinning is caused by:

- (1) Failure to keep the tip covered with fresh solder while not in use.
- (2) High tip temperatures.
- (3) Insufficient melting in soldering operations.
- (4) Wiping the tip on dirty or dry sponges and rags. (Always use a clean, wet, industrial grade, sulfur-free sponge.)
- (5) Impurities in the solder, iron plating, or on the surfaces to be soldered.

## 3. To restore a de-tinned tip

- (1) Remove the tip from the solder handle and allow the tip to cool down.
- (2) Remove scale and oxides from the tinned area of the tip with 80-grit abrasive polyurethane foam stock or a 100-grit emery cloth.
- (3) Wrap rosin core solder ( $\phi 0.8\text{mm}$  diameter or larger) around the newly exposed iron surface, insert the tip into the handle, and turn on the power switch.

**NOTE: the de-tinned tips are preventable by proper daily care!**

## 4. Extend the lifetime of the tip

- (1) Coat the soldering tip with solder before and after using each time. This can prevent the tip from being oxidized and prolong the lifetime of it.
- (2) Choose a low and suitable temperature, this will protect the tip from being oxidized.
- (3) Use fine point tips only when necessary. The plating on fine precision tips is less durable than the plating on blunter tips.
- (4) Do not use the tip as a prying tool. Bending the tip will cause the plating to crack, shorten the lifetime.
- (5) Use the minimum activation flux necessary to do the job. Higher activation flux is more corrosive to the tip plating.

## IV. Specifications

|                             |                            |
|-----------------------------|----------------------------|
| Type                        | QUICK TS1200D              |
| Temperature displaying type | TFT                        |
| Power consumption           | 120W                       |
| Input voltage               | ★110V AC, 220V AC, 230V AC |
| Temperature Range           | 200°C~420°C/392F~780F      |
| Temperature Stability       | ±2°C                       |
| Ambient Temperature(Max)    | 40°C                       |
| Tip to Ground Resistance    | <2mV                       |
| Tip to Ground Potential     | <2Ω                        |
| Dimension (W×H×D)           | 137×168×114mm              |
| Weight                      | About 2.7Kg                |

★Note: Ensure that your power supply data agrees with the information on the nameplate of the machine!

## V. Setting & Operating the Soldering Station

**⚠CAUTION: Before operation, please check whether the voltage accords with the rated voltage on the unit’s nameplate.**

### 5.1 Iron Holder and Sponge

**⚠CAUTION:**

The sponge is compressed. It will swell when moistened with water. Before using the unit, moisten the sponge with the water and squeeze it dry. Failure to do so may result in damage to the soldering tip.

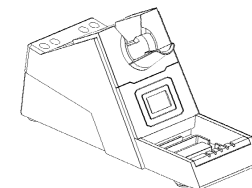

If the sponge becomes dry during working, add appropriate water.

1. Dampen the small cleaning sponge with water and then squeeze it dry.
2. Place it in groove of the iron holder base.
3. Add a little water to iron holder. The small sponge will absorb water to keep the large sponge around it wet at all times.

## 5.2 Connection

### ⚠CAUTION:

**Be sure to turn off the power switch before connecting or disconnecting the soldering iron. Failure to do so may damage the soldering station.**

1. Connect the connector of the handle cord to the socket behind the unit. Take notice of inserting position about connector.
2. Place the soldering iron at the iron holder.
3. Insert the power plug into grounded power socket.
4. Turn on the power switch.

## 5.3 Turn ON/OFF

On/off: soft switching on/off and hard switching on/off;

1. Hard switching: power switch can realize hard switching;

Soft switching: “POWER” key use for soft switching, in hard switching state, long press “POWER” about 3S, turn on and working; and then press “POWER” fig.5-1

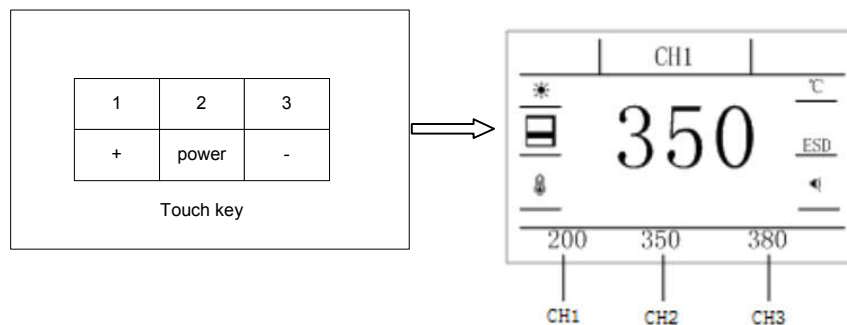

## 2. Cleaning

The remnant flux during soldering process will form oxides and carbides which will cause damage to the tip, soldering difference and thermal recovery decreasing. Clean the tips regularly with the cleaning sponge.

Remove the oxides and carbides once a week if using the soldering station continuously to protect the tip.

## 3. When not use

When the work is finished, don't leave the soldering station at high temperature for long time. Or the flux in the tip will turn to oxides and carbides which will reduce the heat conductivity of the tip largely.

## 4. After use

Wipe the tip and coat it with fresh solder. This will protect the tip from oxidation.

## 8.1 Maintenance of the Tip

### 1. Inspect and Clean the Tip

#### ⚠CAUTION: *Never remove the oxide by filing the tip.*

- (1) Set the temperature at 250°C.
- (2) When the temperature is stable, clean the tip with the cleaning sponge and check the condition of it.
- (3) Coat the tip with solder if there is black oxide around it, then clean it with sponge. Repeat until the black oxide is completely removed. Then coat the tip with solder again. This will protect the tip from oxidation and prolong lifetime of it.
- (4) If the tip is deformed or heavily corroded, replace a new one.

## VII. Calibration

The soldering iron should be recalibrated after changing the iron. The unit adopts digital calibration mode and the revision value is inputted by pressing button, make the adjustment easily.

### Calibrate by using thermometer:

1. Set the unit's temperature to a certain value.
2. When the temperature stabilizes, measure the tip's temperature with thermometer and write down the reading.
3. Press and hold "1" and "3" keys to enter into calibrating temperature mode and LCD display flash, press "+" or "-" key change temperature value, fit with thermometer reading, press "2" to confirm.

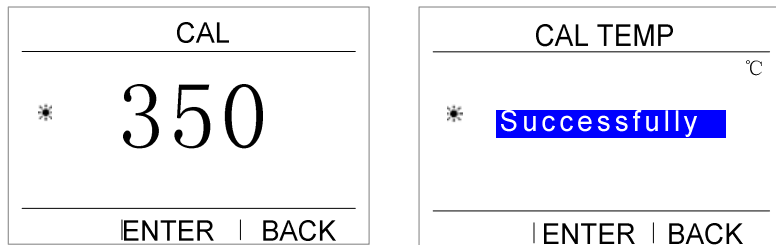

We recommend using the 191/192 thermometer for measuring the tip temperature. If the soldering station is locked by password, it will not be able to calibrate the tip temperature and you must input the right password

## VIII. Use & Tip Maintenance

### 8.0 Tip Use

#### 1. Tip temperature

High temperature will shorten lifetime of the soldering tip. Choose a low and suitable soldering temperature if possible. With the excellent thermal recovery, it can ensure a sufficient and effective soldering event at low temperature to protect sensitive components from damage.

## 5.4 Temperature Setting

### ⚠CAUTION:

**Make sure the temperature of the unit can be adjusted (password is correct or the password is initial 000). When setting temperature, the heating element is on. Operation as following steps:**

There are three channels, short press 1,2,3 key enter into channel 1,2,3. See following picture:

Press "1" key 3s to enter into channel 1, parameter is activated when the word becomes blue, press "+/-" key to change value, press "2" key to save.

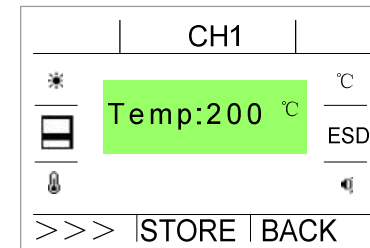

#### Temperature increase:

Press "+" key once to increase the temperature by one digit, press and hold it to continuously increase.

#### Temperature decrease:

Press "-" key once to decrease the temperature by one digit, press and hold it to continuously decrease.

Press 2 key 3s to enter into channel 2, parameter changes to blue font. Express value of number will be modified, press “+/-” key to change value, press “2” key to save.

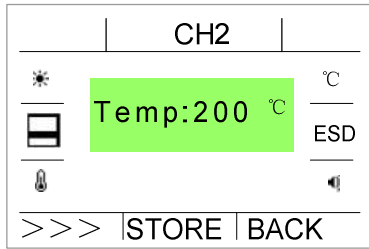

Press 3key (3s) to enter into channel 3, as following picture.

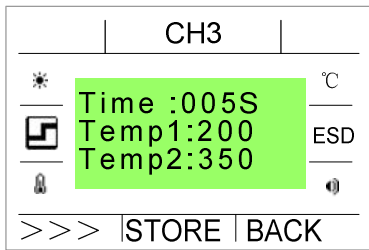

Parameter changes to blue font, Express value of number will modify, press “+/-”key to change value, press “2” key to save.

First temperature get to temperature setting, hands hold Handle area. There will be warning tone, And start timing, After the setting time, it will be warning tone and Jump to the next temperature section.

## 6.10 Language Setting

1. Press “1 or +” key to select “Language”,, press “2” key to enter into language menu ,press “1” key to choose language (English, Simplified Chinese, Traditional Chinese).

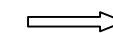
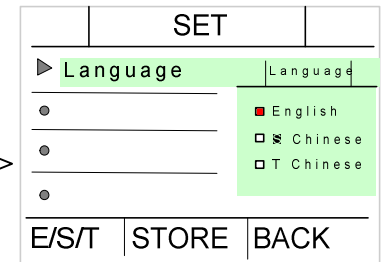
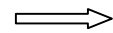
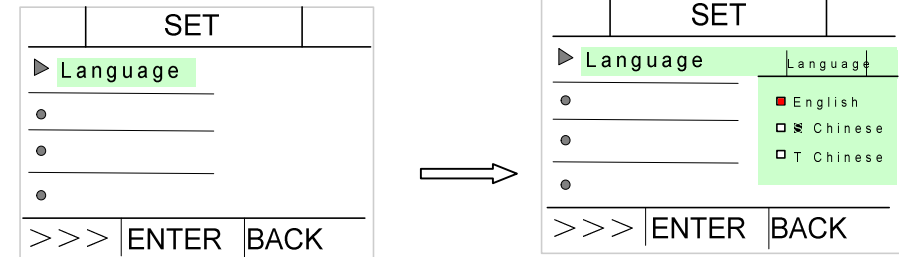

2. After setting language, press “2” key to save,  
3. Press “3” key to back.

## 6.9 Password Setting

1. Press “1 or +” to select “password”, press “2” key to enter reset password interface, press “2” key to activate the Password Menu, press “+” or “-” to import 0, press “1” key to import original password 000000, press “2” key to save, and enter into new password import menu, If the two passwords are the same, it will be modified the password successfully.

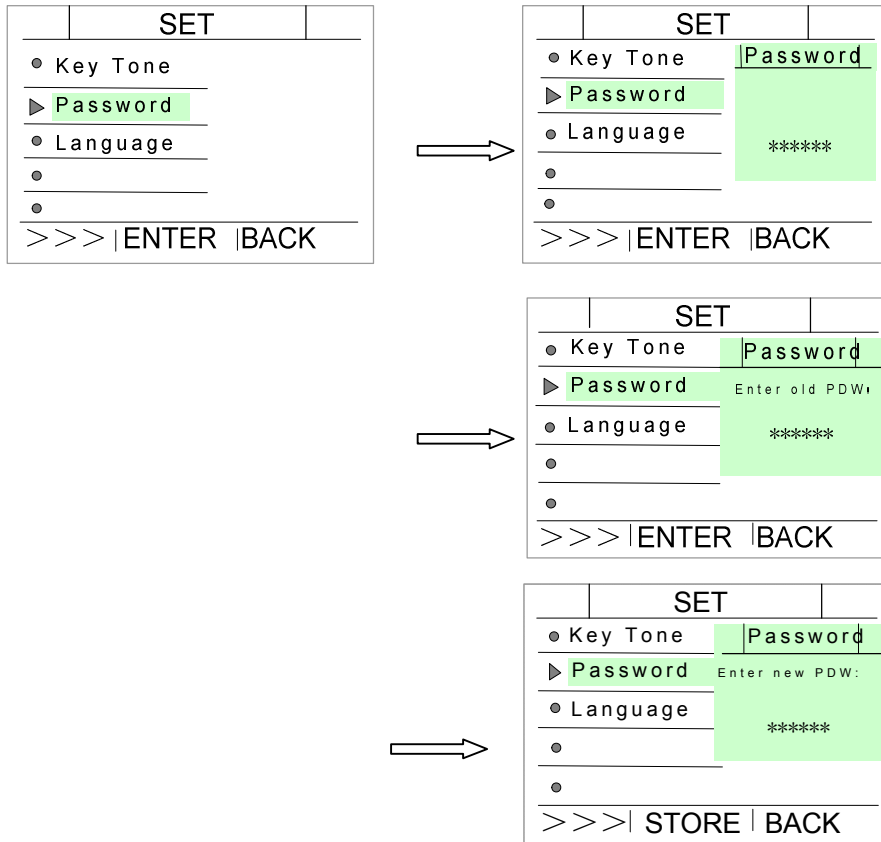

△ Note: After change password, the temperature cannot be modified, enter into parameter setting interface with new right password.

## VI. Menu Setting

### 6.1 Enter into Setting Menu

1. Press “2” and “3” key at the same time to enter into setting main menu, as following picture:

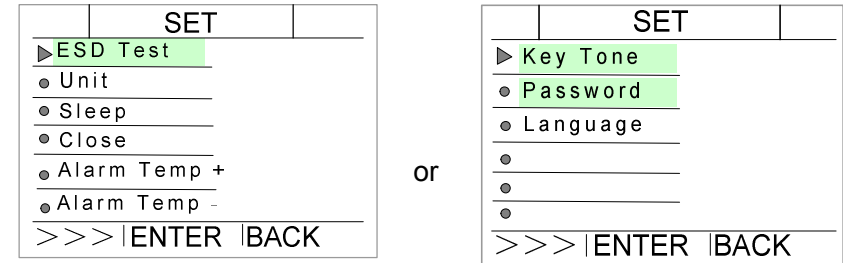

2. Press “2” key to enter into Setting Menu.

### 6.2 ESD Setting

1. Press “1 or +” to select “ESD test”, press “2” key to enter into ESD interface, press “2” key again to enter into ESD select interface, press “1” key to select ON or OFF, ON express open ESD function, OFF express close ESD function, press “2” key to save.

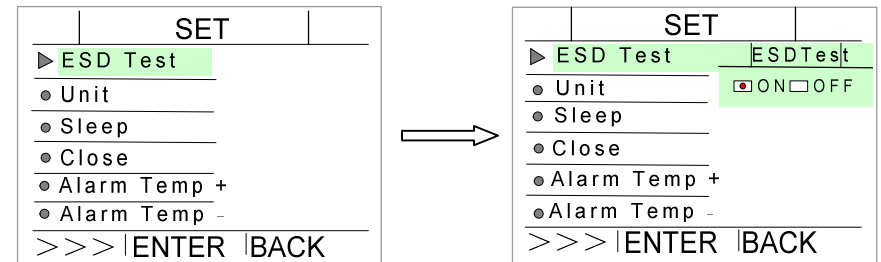

△ Note: when select ON, the ground hole must be connect with ESD ground, otherwise, alarm hint (ESD in main interface show as red)  
2. After setting ESD function, press “2” key to save and press “3” key to back.



### 6.3 Unit Setting

1. Press “1 or +” key to select “unit”, press “2” key to enter into temperature unit setting interface, press “2” key to activate Unit Menu, press “1” key to select temperature unit. See following picture

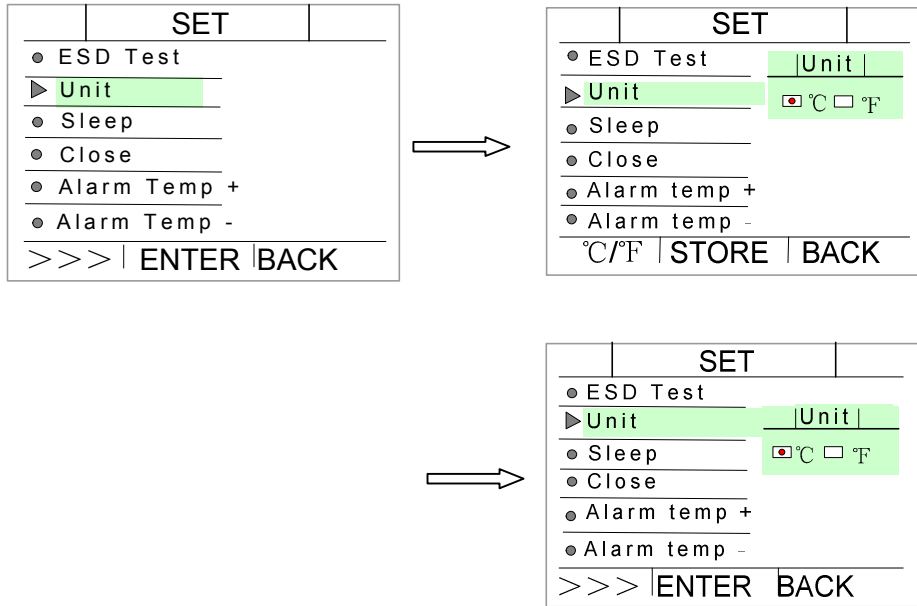

2. After selecting temperature unit, press “2” key to save.
3. Press “3” key to back.

### 6.8 Key Tone Setting

1. Press “1 or +” key to select “Key Tone”, press “2” key to enter into key tone setting interface, press “2” key to activate Key Tone Menu, press “1” to select ON or OFF, ON express open key tone, OFF express close key tone, press “ENTER” to confirm.

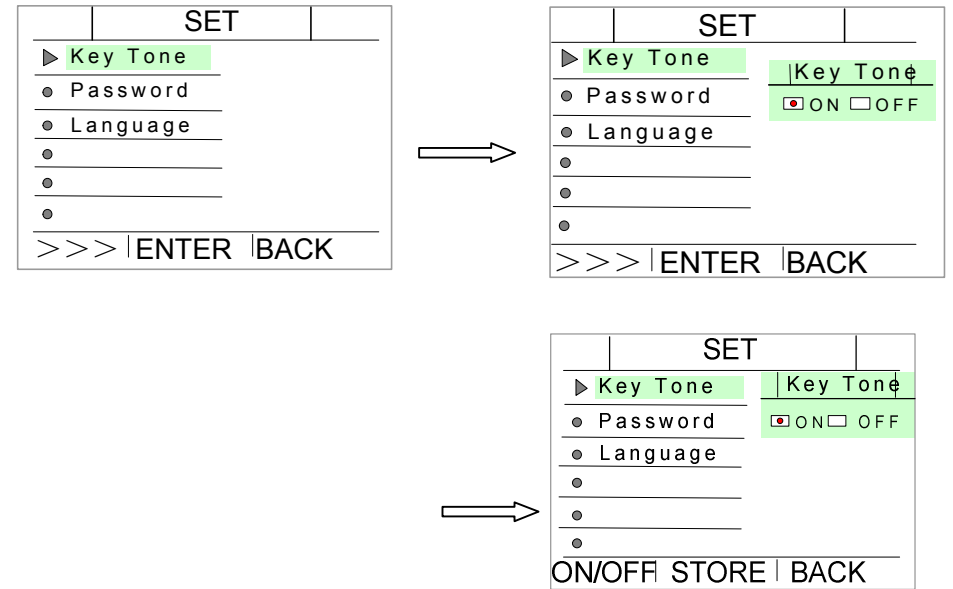

2. After setting key tone, press “2” key to save.
3. Press “3” key to back.

## 6.7 Alarm Temperature- Setting

1. Press “1 or +” to select “Alarm temp-”, press “2” key to enter into alarm temperature setting interface, press “2” key to activate Temperature Alarm- Menu, press “1” key to select ON or OFF, OFF express not alarm, ON express alarm, press “+” or “-” to modify temperature range. The range of alarm temperature is: 2~99°C.

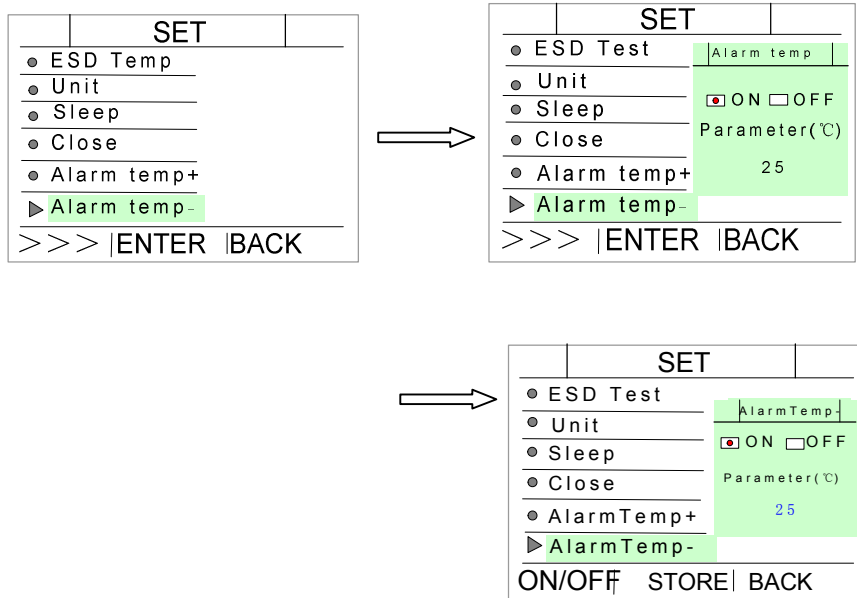

2. After setting alarm temperature-, press “2” key to confirm.  
3. Press “3” key to back.

## 6.4 Sleep Time Setting

1. Press “1 or +” key to move the cursor, press “2” key to enter into sleep time setting interface, press “2” key to activate Sleep Time Menu, press “1” to select ON or OFF, OFF is not sleeping, when choose ON, press “+” or “-” to modify sleeping time.

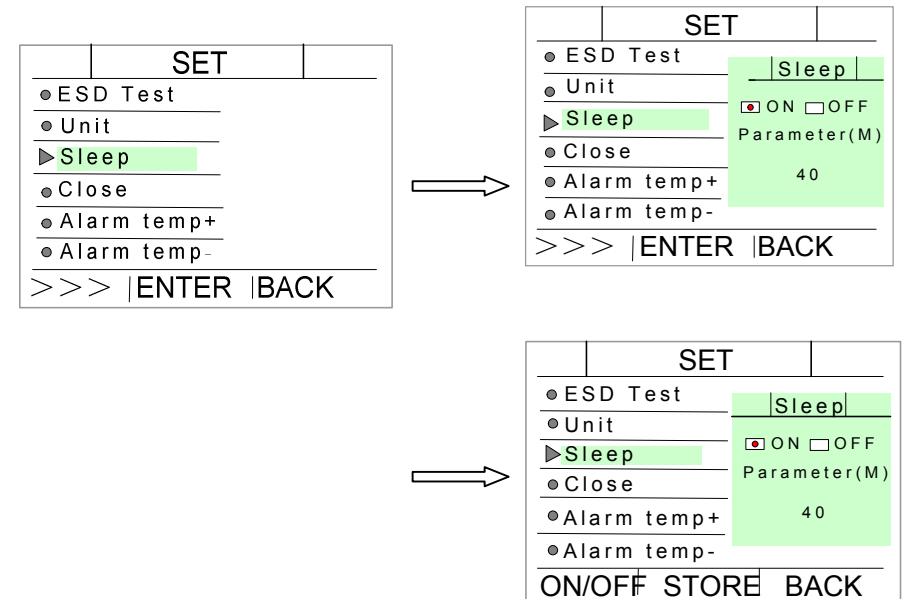

- △ The soldering station enters into sleep state with a beep.
- △ After entering the sleep state, the figure “” will be displayed and the LCD display screen will dim.
- △ Note: The sleeping time range is 5s to 99 m, press any touch switch to activate station.
- △ The sleep time is reached, the soldering station will power off automatically.

2. After setting sleeping time, press “2” key to confirm.  
3. Press “3” key to back.

## 6.5 Close Time Setting

1. Press “1 or +” key to select “Close”, press “2” key to enter into close time setting interface, press “2” key to activate Close Time Menu, press “+” or “-”key to modify value. Close time setting range is 1-240min.

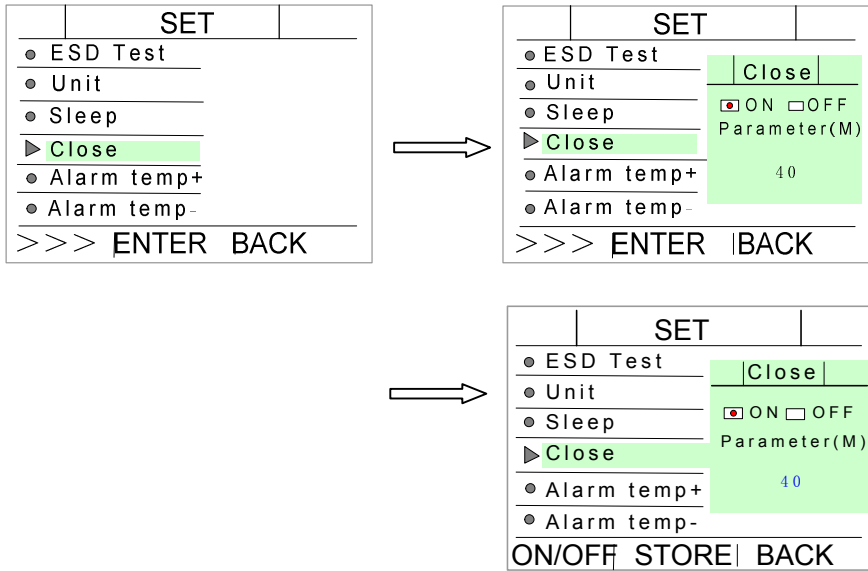

2. After setting close time, press “2” key to confirm.

3. Press “3” key to back.

## 6.6 Alarm Temperature+ Setting

1. Press “1 or +” to select “Alarm temp+”, press “2” key to enter into alarm temperature setting interface, press “2” key to activate Temperature Alarm Menu, press “1” to select ON or OFF, OFF express not alarm, ON express alarm, press “+” or “-” key to modify temperature value. The alarm temperature range is 2~99°C.

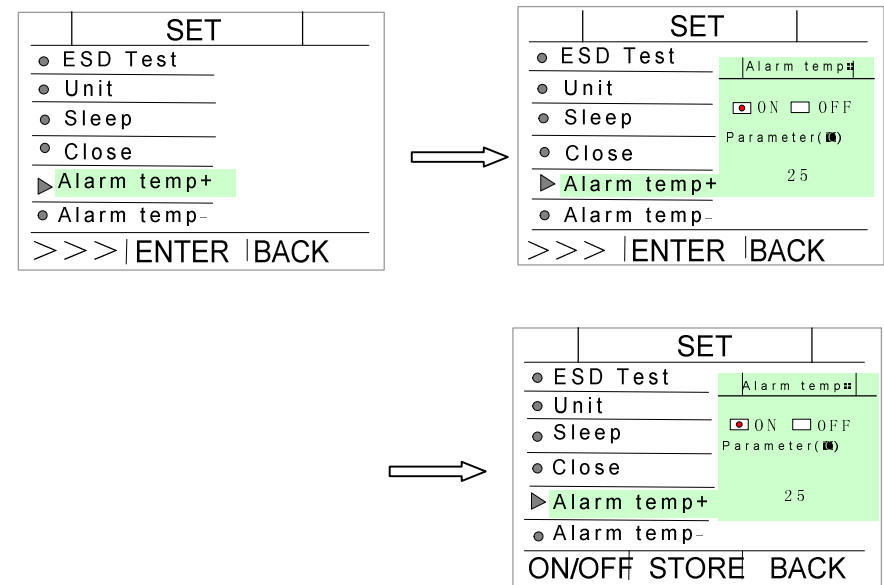

2. After setting alarm temperature+, press “2” key to confirm

3. Press “3” key to back.