

QUICK 713

LEAD FREE REWORK SYSTEM

Instruction Manual

Thank you for purchasing this unit. It is designed for lead free soldering & de-soldering. Please read this manual before operating the unit. Store this manual in a safe, easily accessible place for future reference.

TABLE CONTENT

1. Summary.....	2
2. Safety Instruction.....	2
3. Specification and Characteristic.....	3
3.1 Soldering Iron Part	3
3.2 De-soldering Tool Part	3
3.3 SMD Rework Part	3
4. Prepare and Connection	4
4.1 Connection of the Soldering Iron Part.....	4
4.2 Connection of the De-soldering Tool Gun.....	5
4.3 Connection of the SMD Rework Part.....	6
4.4 Connection of the Main Unit.....	6
5. Parameter Setting.....	6
5.1 Menu and Parameter Setting.....	6
5.2 Temperature and Airflow Setting.....	7
5.3 Sleep Time Setting and Resume.....	8
6. Operation.....	9
6.1 Select the Tool.....	9
6.2 Operation of the Soldering Iron	10
6.3 Operation of the De-soldering Gun.....	11
6.4 Operation of the SMD Rework System	13
6.5 On Line with the Hot Plate.....	14
7. Temperature Calibration.....	14
8. Error Messages.....	15
9. Care and Maintenance.....	15
9.1 Maintenance of the Soldering Iron	15
9.2 Maintenance and servicing of the De-soldering Gun.....	18
9.3 Parts Assemble and Disassemble of the SMD Rework	23
9.4 Replace the Fuse.....	23
10. Tips.....	24

I. Summary

Thank you for purchasing the unit which including the soldering iron part, de-soldering gun part and SMD rework part. It is a good assistant. The three tools can work at the same time.

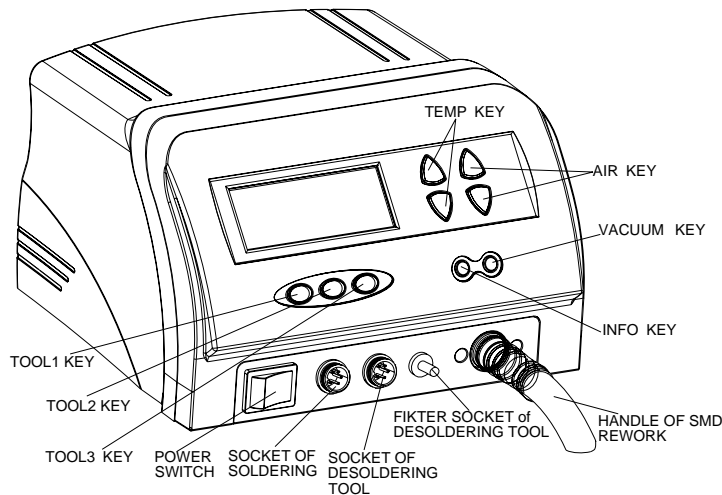

II. Safety Instruction

- Please use the unit only as the described manner, and avoid abusing it.
- The unit shall only be used with rated voltage and frequency. (Refer to the trademark back of the equipment.)
- The unit is equipped with a 3-wires grounding plug and must be plugged into a 3-terminal grounded socket. Do not modify plug or use an ungrounded power socket. If an extension cord is necessary, use only a 3-wire extended grounding cord.
- When the power is on, do not touch the metal part because the temperature of the tip, or the nozzle, or the sucking nozzle will be up to very high, which may be hurt you.
- Do not wet the soldering station. Don't use or disconnect it with wet hands, and without to force the supply cord.
- Advise other people in the working area to turn the power off when in a break or after using the unit because the unit can reach a very high temperature and may cause potentially dangerous.
- No replace any parts or install the tips before turning the power off and cooling down the searing-iron to room temperature.
- Do not use the unit near the flammable items.
- The soldering process will produce smoke, so make sure the area is well ventilated.
- A periodically maintenance (description see in this manual) of the unit is necessary. Do not use the unit if it is damaged, especially the power supply cord and the case.
- Do not modify the unit by oneself.
- Replace only with genuine parts.
- Children do not recognize the risks of the electrical appliance. Therefore use and keep the unit out of the reach from children.

III. Specification and Characteristic

3.1 Soldering Iron Part

3.1.1 Specification of the Soldering Part

Power	60W
The temperature range of the iron	200°C~480°C
The time range of the sleeping	0~99 (unit: minute)
Temperature Stability	±2°C (Without air flow and no load)
Highest Ambient Temperature	40°C
Tip to Ground Resistance	<2 Ω
Tip to Ground Potential	<2mV
Heating Element	Electromagnetic heater

3.1.2 Characteristic of the Soldering Part

1. Recovery of the temperature and caefactive is rapid and exactly. Display the temperature with the large LCD by microcomputer and Control the temperature by PID. Especially it is suitable to the lead free soldering.
2. Lock the calibration and the parameter setting with the password.
3. Digital adjustment of the temperature and with functions of sleeping or shut off one tools.
4. Digital calibration and operate conveniently and easy.
5. Various types of tips are available and replace tips conveniently.
6. The soldering handle is light and use is comfortable.

3.2 De-soldering Tool Part

3.2.1 Specification of the De-soldering Tool

Power of the pump	12V/2A
Power of heating	90W
Temperature of nozzle	200°C~480°C (See the working mode table)
Pump	Diaphragm pump
Vacuum suction	600mmHG
Nozzle to ground resistance	Less than 2 Ω
Nozzle to ground potential	Less than 2mV
The time range of the sleeping	0~99 (unit: minute)

3.2.2 Characteristic of the De-soldering Tool

1. Powerful built-in vacuum pump, without connecting the outer vacuum system.
2. Sensor closed-loop temperature control for heating system, precise temperature.
3. Heater which is 36V powered is fully isolated form mains. Safe and reliable.
4. Key type adjusting parameters and with auto sleeping function.
5. Temperature calibrate digitally.
6. Suction nozzle and heater are specially designed so that even the melting solder can be absorbed into the filter

without frequent maintenance. High efficiency.

7. Heat resistant vacuum hose used prevents it from being burned by touching the heating parts.

3.3 SMD Rework part

3.3.1 Specification of the SMD Rework system

Power	1000W
Temperature range	100°C~500°C
Airflow range	1~120
Maximal airflow	120 L/min

3.2.2 Characteristic of the De-soldering Tool

1. There is lock-function and the parameter setting with password protection.
2. Real-time operation and automatically sleeping function when putting the handle on the holder.
3. Closed loop sensor, temperature can be controlled by zero voltage triggering mode. Large power and rapid heating. Temperature can be conveniently adjusted and the temperature is accurate and stable, and not affected by airflow.
4. It is with a brushless whirlpool motor and the airflow is adjustable with a wide range but no level. It is a multipurpose unit.
5. Automatic cooling system can prolong the heating element's life and protect the handle.

3.2.3 Usage

1. It is suitable to the de-soldering of the SMD components, such as SOIC, CHIP, QFP, PLCC, BGA and so on.
2. It is suitable to hot shrink, drying, remove lacquer and mucosity, thaw, preheating, disinfect and so on.
3. It is suitable for the situation needing different range airflow, softer or heavier.

IV. Prepare and Connection

Note: Check the parts in the package as the packing list. Some option parts may be not in the package if do not order.

4.1 Connection of the Soldering Iron Part

1. Iron Holder and Sponge
 - (1) Dampen the small cleaning sponge with water and then squeeze it dry. Place it in the groove of the iron holder base.
 - (2) Add a little water to the iron holder. The small sponge will absorb the water to keep the large sponge above it wet all times. It may only use big sponge and not use small one.
 - (3) Dampen the larger cleaning sponge and place it on the iron holder base.
 - (4) During the operation, it also can clean the tip with the cleaning ball which is made of soft brass wires.

 CAUTION: If the sponge becomes dry during working, add appropriate water.

2. Connection

- (1) Connect the connector plug of the iron handle cord to the socket "TOOL1" in front of the soldering station. Take notice of the inserting position of connector plug.
- (2) Place the soldering iron in the iron holder.

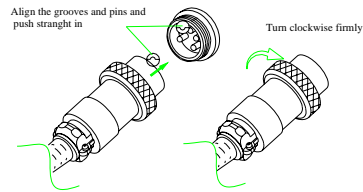

4.2 Connection of the De-soldering Tool Gun

4.2.1 Names of De-soldering Gun

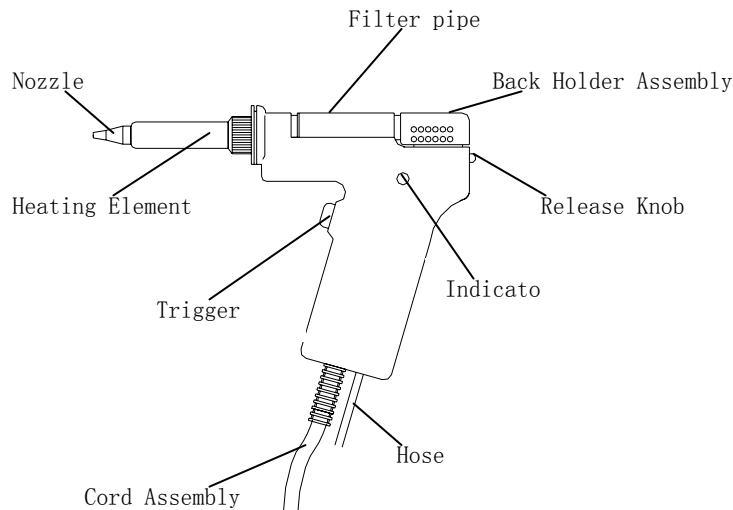

Nozzle: Transmits heat for melting solder. It is entrance of the melted solder. Expendable part.

Filter Pipe: Inside it, there is the ceramic paper filter (s) and spring filter pipe of the melted solder and flux.

Spring filter pipe is expendable part.

Back Holder Assembly: Secures the filter pipe.

Release Knob: Push down to remove the filter pipe.

Indicator: Indicate when nozzle and heating element need cleaning and when filters need replacing.

Hose: Connects to the outside filter.

Trigger: Squeeze to start absorption. Do not pull the trigger before fully heating the nozzle.

Heating Element: Require clean of its Inside.

Cord Assembly: Connects to the receptacle

4.2.2 Use of the Sponge and the Gun's Holder

1. Take out the de-soldering gun and put it in gun's holder.
2. Dampen the cleaning sponge with water and then squeeze it dry. Be sure to remove the round portion of the sponge and place it in the holder.
3. Connect the metal plug of cord assembly to the receptacle (marked "TOOL2").

4. Connect the external filter to the tie-in's hose on the unit, in accordance with the mark on the external filter, need to insert fully, and connect the other side of filter to de-soldering gun's hose.

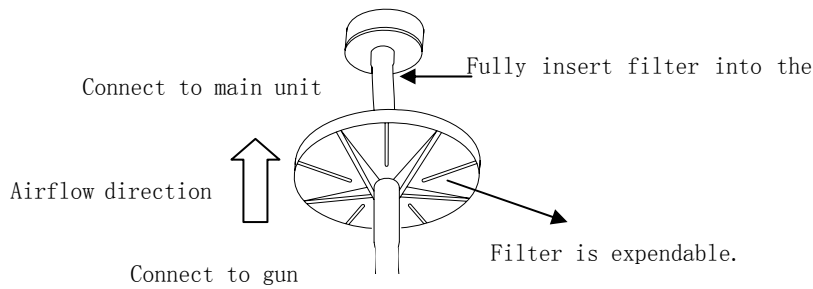

Note: The external filter has connection orientation, and it must be connected according to the mark, otherwise affect suction.

4.3 Connection of the SMD Rework Part

Select suitable nozzle to install. After that, put the re-soldering handle on the holder.



4.4 Connection of the Main Unit

1. Insert the power plug into the grounding power socket.
2. Connect one end of grounding cord to the grounding hole of the soldering station and the other to ground.
3. Switch on the power supply.

V. Parameter Setting

5.1 Menu and Parameter Setting

5.1.1 Enter into the Menu

1. Turn off the power switch.
2. Press and hold the “INFO” and “VACUUM” keys simultaneously and not loosen, and then turn on the power switch. At the time, the LCD shows . After that, the LCD shows  (as followings).

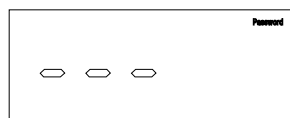



Which means it has come into the password inputting interface of the menu setting. Only when the inputting password is right, it can enter into the menu setting.

3. Input password: Click the “TEMP▲” or “TEMP▼” key to input 100's digit. And then click the “VACCUM” key when the selected value of the 100's digit displaying and then into the 10's digit set. The setting methods of the 10's digit and 1's digit are same with the 100's digit.
4. There are two times to input the password. If the inputting password is not right at the first time, the process returns the password-inputting window at once. If the password inputting is error two times continues, it comes into the work state and the displaying will shows “🔒”, at the time, temperature and airflow cannot be set.
5. If the password is right, the displaying window will display “”, and then click “VACUUM” key into the menu setting state. The window shows “set”, at the time, it can change the parameters of the menu.

5.1.2 Menu and Parameters Setting

1. There are three submenus: “-1-”, “-2-”, “-3-”. Click “TEMP▲” or “TEMP▼” key can select the submenu. After selecting, click “VACUUM” key into the parameter setting of the submenu.
2. Submenu “-1-” means: when click the “VACUUM” key, it can exit from the menu setting and enter into the work state.
3. Submenu “-2-” means sound setting (refer to the 5.1.3 sound setting).
4. Submenu “-3-” means password setting. The LCD displays “” after into the submenu “-3-” (refer to the 5.1.4 password setting).
5. After setting the parameters in the submenu “-2-” or “-3-”, click “VACUUM” key” to the “-1-”.

5.1.3 Sound Setting

1. Click “TEMP▲” or “TEMP▼” key to select “-2-”in the menu setting and then click “VACUUM” key enter into the sound setting. The LCD shows “SP”.
2. Click “TEMP▲” or “TEMP▼” key to select sound mark “”. If “” mark displaying, it means the unit has sound hinting. If not “” mark displaying, it means without sound.
3. After setting, click “VACUUM” key to return submenu“-1-”.

5.1.4 Password Setting

1. Click “TEMP▲” or “TEMP▼” key to select “-3-”in the menu setting and then click “VACUUM” key enter into the password setting. The LCD shows “” and the 100’s flicking.
2. Click “TEMP▲” or “TEMP▼” key to change the hundred digital and then click “VACUUM” key to ten digital set. Ten digital and one digital setting method is the same as the hundred digital setting. After finishing the first time password inputting, click “VACUUM” key to the secondary password input.
3. If the password is not the same as last time, click “VACUUM” key to return submenu“-1-”.
4. If the password is the same as the last time, the changed password is successful. The new password is stored into the unit. Click “VACUUM” key and the LCD shows “OK” and then return submenu“-1-”.

5.2 Temperature and Airflow Setting

Click “TOOL1”, “TOOL2”, “TOOL3” key into the single displaying window, and then click “TEMP▲” or “TEMP▲” key or “AIR▲” key or “AIR▼” key to change the temperature or the airflow.

CAUTION:

- Make sure the temperature of the station can be adjusted (the password is right or the password is initial “000”).
- Only when the tool is in the single displaying state, it can set the temperature and the airflow.
- If the power supply is cut off when setting, the setting data will not be stored.

5.2.1 Temperature Setting

Raise temperature: Click “TEMP ▲” key and then the temperature will rise 1 °C, and the LCD displays the

current setting temperature. If pressing “TEMP ▲” not loosely at least one second, the setting temperature will rise rapidly. Loose the “TEMP ▲” key until up to the needed temperature.

Reduce temperature: Click “TEMP ▼” key and then the temperature will drop 1 °C, and the LCD displays the current setting temperature. If pressing “TEMP ▼” key not loosely at least one second, the setting temperature will drop rapidly. Loose the “TEMP ▼” key until down to the needed temperature.

5.2.2 Airflow Setting

Raise Airflow: Click “AIR ▲” key and then the airflow grade will rise 1, and the LCD displays the current setting airflow grade. If pressing “AIR ▲”not loosely at least one second, the setting airflow grade will rise rapidly. Loose the “AIR ▲”key until up to the needed airflow grade.

Reduce Airflow: Click “AIR ▼” key and then the airflow grade will drop 1, and the LCD displays the current setting airflow grade. If pressing “AIR ▼”not loosely at least one second, the setting airflow grade will drop rapidly. Loose the “AIR ▼”key until down to the needed airflow grade.

5.3 Sleep Time Setting and Resume

5.3.1 Sleep Time Setting

1. Sleep time setting of the soldering iron: click “TOOL1”key into the single displaying window of the soldering iron. And then pressing the “INFO” key and not loosen, at the time, click “TEMP▲” or “TEMP▼” key to change the sleeping time.

The sleeping time range of the soldering iron is from 0 to 99minutes.

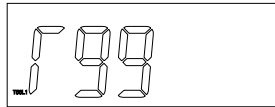

Sleeping time interface of the soldering iron

2. Sleep time setting of the re-soldering gun: click “TOOL2”key into the single displaying window of the re-soldering gun. And then pressing the “INFO” key and not loosen, at the time, click “TEMP▲” or “TEMP▼” key to change the sleeping time.

The sleeping time range of the re-soldering gun is from 0 to 99minutes.

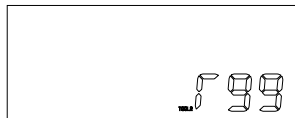

Sleeping time interface of the re-soldering gun

3. Sleep time setting of the SMD Rework Tool: click “TOOL3” key into the single displaying window of the SMD rework tool. And then pressing the “INFO” key and not loosen, at the time, click “TEMP▲” or “TEMP▼” key to change the sleeping time.

The sleeping time range of the SMD rework tool is from 0 to 999seconds.

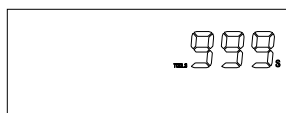

Sleeping time interface of the SMD rework tool

5.3.2 Resume from the Sleep

1. Resume of the soldering iron:
 - 1) Click “TOOL1” key.
 - 2) Take up the soldering iron handle from the holder.
2. Resume of the re-soldering gun:
 - 1) Click “TOOL2” key.
 - 2) Take up the re-soldering gun and press the red switch on it.
3. Resume of the SMD rework tool:
 - 1) Click “TOOL3” key.
 - 2) Take up the rework handle from the holder.

VI. Operation

Connect the grounding cord before operation. One end connects with the grounding jack at the back of the unit and the other end to the earth. After that, turn on the power switch.

6.1 Select the Tool

1. There are three tools to select, soldering iron, re-soldering gun and the SMD rework tool. The LCD can shows the work states of the three tools together, also can shows single.

The following picture is showing the sleeping states of all tools together.

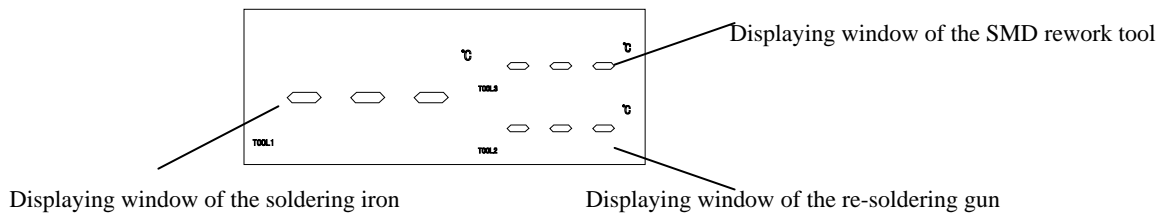

2. In the whole displaying window, click “TOOL1” or “TOOL2” or “TOOL3” key into the single displaying. In the single displaying state, the unit will return the whole displaying window if without operation about 5seconds.

TOOL1: key of the soldering iron

TOOL2: key of the re-soldering gun

TOOL3: key of the SMD rework tool

3. In the whole displaying window, click “TOOL1” key into the single displaying window of the soldering iron. The LCD displays “SET” and current setting temperature. Click “TEMP▲” or “TEMP▼” to set the temperature of the soldering iron.

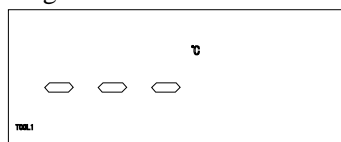

Soldering iron in sleeping

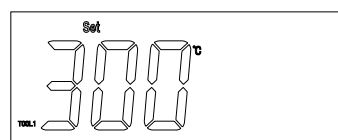

Soldering iron in setting state

4. Click “TOOL2” key into the single displaying window of the re-soldering gun. The LCD displays “SET” and current setting temperature. Click “TEMP▲” or “TEMP▼” to set the temperature of the re-soldering gun.

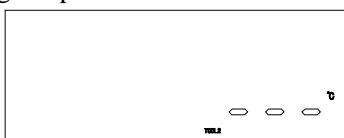

Re-soldering gun in sleeping

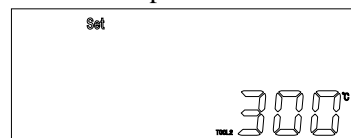

Re-soldering gun in setting state

- Click “TOOL3” key into the single displaying window of the SMD rework tool. The LCD displays “SET” and current setting temperature. Click “TEMP▲” or “TEMP▼” to set the temperature of the SMD rework tool. Click “AIR▲” or “AIR▼” to set the airflow of the SMD rework tool. When the SMD rework tool is in the sleeping state, the window shows “---”.

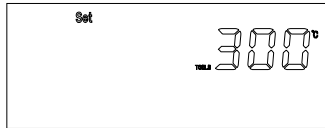

In temperature setting state

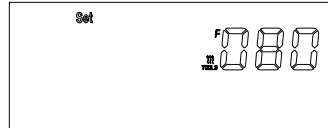

In airflow setting state

- In the single displaying state, it can turn on or turn off the corresponding tool by clicking the corresponding “TOOL” key. When the window displays “-”, which means the tool has been turn off.

6.2 Operation of the Soldering Iron

6.2.1 Enter into or Exit from the Soldering Iron

- Turn on the power switch, click“TOOL1” key into the single displaying state of soldering iron.
- If displaying “-” at the soldering iron window, which means the soldering iron is in the shutting state and cannot be operated. At the state, if pressing “TOOL1” key about three seconds, the soldering iron window will shows “ON”, which means the soldering iron can work normally.
- Pressing “TOOL1” key again, the soldering iron window will shows “OFF” and then “-”, which means the soldering iron has been into the shutting state.
- If displaying “---” at the soldering iron window, which means it is in the sleeping state. The soldering iron comes to heat up when waking up from the sleeping state, the “⚙️” lights and when the temperature is stable, the “⚙️” flickers.

6.2.2 Set the Temperature of the Soldering Iron

Make sure the temperature of the station can be adjusted (the password is right or the password is initial “000”). Click “TOOL1” key into the single displaying window of the soldering iron, and then click “TEMP▲” or “TEMP ▼” key to change the temperature (refer to the temperature setting).

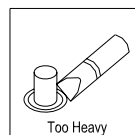
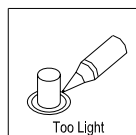
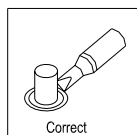

6.2.3 Select a Correct Tip

- Select a tip which maximizes contacting area between the tip and solder joint. Maximizing contact area transfers the heat more efficient, helping the operators to produce high quality solder joints quickly.
- Select a tip with transferring the heat to the solder joint well. A tip with shorter length can control more precise. And the Longer or angled tip may be needed for soldering densely populated boards.



6.3 Operation of the De-soldering Gun

6.3.1 Enter or Exit from the State of the De-soldering Gun

1. Turn on the power switch, click“TOOL2” key into the displaying state of de-soldering gun and only displaying the temperature of the de-soldering gun.
2. If displaying “-” at the de-soldering gun window, which means the de-soldering gun is in the shutting state and cannot be operated. At the state, if pressing “TOOL2” key about three seconds, the de-soldering gun window will shows “ON”, which means the de-soldering gun can work normally.
3. Pressing “TOOL2” key again, the de-soldering gun window will shows “OFF” and then “-”, which means the de-soldering gun has been into the shutting state.
4. If displaying “---” at the de-soldering gun window, which means the de-soldering gun is in the sleeping state. The de-soldering gun comes to heat up when waking up from the sleeping state, the “” lights and when the temperature is stable, the “” flickers.

6.3.2 Set the Temperature of the De-soldering Gun

When only displaying the “de-soldering gun” alone, click the “TEMP” key to change the temperature. The temperature of the de-soldering gun can be set between 200℃ and 480℃, and the setting method can refer to the “5.2.1 temperature setting”. But it is best to set the appropriate temperature as the different PCB (see the following table).

Temperature	PCB
280-350 ℃	Single-sided PCB
320-400 ℃	Through-hole PCB
350-450 ℃	Multi-layer PCB

6.3.3 Operation of the De-soldering Gun

WARNING:

- High temperature work will shorten the life of the heater and the suction nozzle which will be oxidated and damaged because of the too high temperature. So use as low temperature as possible when work.
- Always set the temperature to as low as possible for the work being done.

NOTE: the de-soldering gun cannot to suck the solder when the sucking nozzle of the SMD rework tool is in work and the bump is in startup state.

1. After switch as the de-soldering work state, wait 3 minutes before beginning the de-soldering operations.
2. Melt the solder: Apply the nozzle to melt the solder after the temperature has stabilized.

CAUTION:

- a) Never allow the nozzle to touch the board itself.
- b) To confirm that all the solder is melted, observe the inside of the hole and the backside of the PCB. If this is difficult to do, try slowly moving the lead with the nozzle. If the lead can move, the solder is melted.

c) Never move the lead by force. If it doesn't move easily, the solder isn't yet fully melted.

3. **Absorb the solder:** After confirming that the solder is completely melted, absorb the solder by squeezing the trigger on the gun. After fully absorbing all the solder, cool the soldering junction in order to prevent it from becoming re-melt.

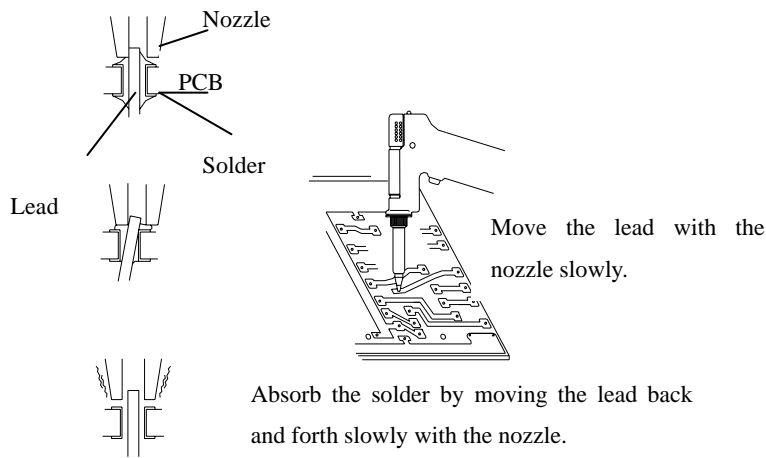

4. **Problems during de-soldering:** If solder remains, it must solder the component again and repeat the de-soldering process as above.
5. **Clean the tip of the nozzle:** Keep the solder-plated section of the nozzle shiny by coating it with a small amount of solder. If the tip of the nozzle is coated with oxide, the nozzle's heat conductivity will be lowered. Coating the tip with a small amount of fresh solder ensures maximum heat conductivity.

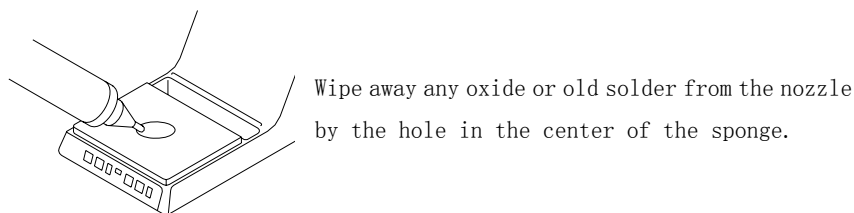

6.3.4 Cleaning during the Process of Operation

The absorbed solder by nozzle must be cleaned in time to insure the unit work normally.

6.3.4.1 Observing the Indicator

1. Make sure that the hole of the nozzle is open and without jam before observing the indicator which can indicate the parts of the de-soldering gun need clean or not.
2. Pull the trigger and look at the indicator.
3. If the indicator is red, clean the nozzle and heating element, empty the filter pipe, and replace the filters. If the indicator is blue, cleaning is not necessary and operations can be resumed.

Normal	Abnormal	Solution
Blue or slight amount of red can be seen.	More than half of the indicator is red.	If the indicator is more than half red, replace the filter and clean the nozzle and the inside of the heating element.

CAUTION:

- The results of the indicator will not be accurate if the hole of the nozzle is closed or if the solder in the hole

of the PCB is not melted.

- Clean the nozzle and heating element with the cleaning pin if there is a noticeable drop in suction efficiency.

6.3.4.2 Replacing the Filter Pipe

Replace the filter pipe as shown step ①~③. During operation, the filter pipe is very hot. Wait until the filter pipe is cool before replacing the filter.

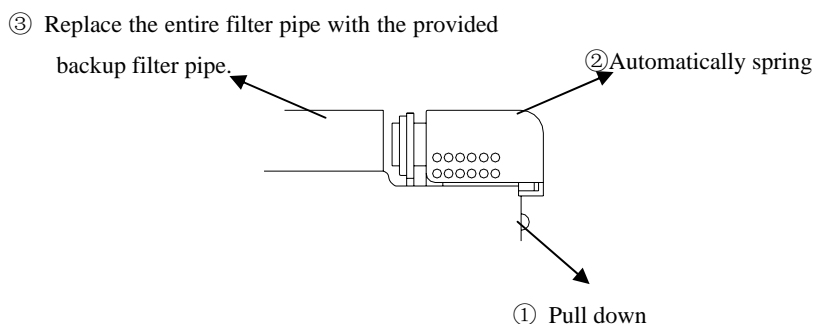

6.4 Operation of the SMD Rework Tool

6.4.1 Enter or Exit from the State of the SMD Rework Tool

1. Turn on the power switch, click “TOOL3” key into the single displaying state of SMD rework tool.
2. If displaying “-” at the SMD rework tool window, which means the SMD rework tool is in the shutting state and cannot be operated. At the state, if pressing “TOOL3” key about three seconds, the SMD rework tool window will shows “ON”, which means the SMD rework tool can work normally.
3. Pressing “TOOL3” key again, the SMD rework tool window will shows “OFF” and then “-”, which means the SMD rework tool has been into the shutting state.
4. If displaying “---” at the SMD rework tool window, which means the SMD rework tool is in the sleeping state. The SMD rework tool comes to heat up when waking up from the sleeping state, the “⚙” lights and when the temperature is stable, the “⚙” flickers.

6.4.2 Set the Temperature and Airflow of the SMD Rework Tool

Click “TOOL3” key into the single displaying window of the SMD rework tool, and then click “TEMP▲” or “TEMP▼” key to change the temperature and click “AIR▲” or “AIR▼” key to change the airflow (refer to the temperature and airflow setting).

6.4.3 Operation

NOTE: the sucking nozzle of the rework handle cannot suck chip when the de-soldering gun is sucking solder because the bump has been used by the de-soldering gun.

1. Select the appropriate nozzle to install on the handle.
2. Take up the handle and the handle can come into the normal work state (if it is in sleeping state).
3. Turn the knob on the middle of the handle to make the sucking pole out or in. install an appropriate sucking nozzle on it.
4. When de-soldering the chip, once the solder has melt, click “VACCUM” key, it can start-up the bump and then use the sucking nozzle to suck the chip. Close the bump by clicking “VACCUM” key again.

-
5. After finishing work, take down the handle on the holder. When the temperature is less than 100°C, it enters into the sleeping state.

 CAUTION:

For prolong the life of the heater and protect the safety of the chip, use as low temperature as possible and as big airflow as possible if it can finish the de-soldering work.

6.5 On Line with the Hot Plate

This unit can work together with a kind of the preheat plate by the special connection cord.

Take out the cord from the package. One end of the cord connects with the six-pins socket on the back of the unit, and the other end connects with preheat plate. Detailed operation can refer to the manual of the preheat plate.

VII. Temperature Calibration

1. If the unit is locked by password, it will not be able to calibrate the temperature and you must input the right password.
2. The corresponding temperature should be recalibrated after replacing the de-soldering gun or heating element or nozzle or tip every time. It adopts digital calibration mode and input the revision value is input by pressing button, make the adjustment simply and quickly.
3. Method of recalibrating temperature: Use the thermometer to calibrate, and it is precise comparatively.
 - ① Set one kind tool's temperature to a certain value(300°C).
 - ② When the temperature stabilizes, measure the temperature with thermometer and write down the reading.
 - ③ In the single displaying state, press the "TOOL1" or "TOOL2" or "TOOL3" and not loosen, and then press the "TEMP▲" and "TEMP▼" keys simultaneously, the unit enters into calibrating temperature mode. The LCD shows "CAL" about 2seconds and then into the temperature-inputting interface.
 - **Calibration the temperature of the soldering iron:** press the "TOOL1" key not loosen, and then press the "TEMP▲" and "TEMP▼" keys simultaneously, the unit enters into the calibrating temperature mode of the soldering iron.
 - **Calibration the temperature of the de-soldering gun:** press the "TOOL2" key not loosen, and then press the "TEMP▲" and "TEMP▼" keys simultaneously, the unit enters into the calibrating temperature mode of the de-soldering gun.
 - **Calibration the temperature of the SMD rework tool:** press the "TOOL3" key not loosen, and then press the "TEMP▲" and "TEMP▼" keys simultaneously, the unit enters into the calibrating temperature mode of the SMD rework tool.
 - ④ At the moment, the digit of LCD display temperature is flashing. Press the "TEMP▲" or "TEMP▼" key to select the value and input the reading of thermometer, and the inputting method is the same as temperature setting.
 - ⑤ Press "VACUUM" key. Here, the whole calibration operation has been finished.
 - ⑥ If the calibration is successful, the LCD shows "OK" and return to work state.

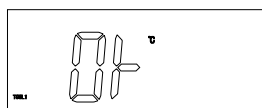

- ⑦ If the temperature still has deflection, you can repeat calibration in accordance with above steps.
- Recommend using the 191/192 thermometer for measuring the temperature.

VIII. Error Messages

Various error messages will be displayed when there are some problems with the parts.

S - E

Sensor Error: If there is a failure in the sensor or anywhere in the sensor circuit, “S-E” will be displayed and power to the part will be cut off.

H - E

Heater error: If there is a failure in the heater element or anywhere in the heater circuit, “H-E” will be displayed and power to the part will be cut off.

ERR

Motor error: If there is some malfunction in the blower or in the blower circuit, the display window will display “**ERR**” and without wind blowing from the handle.

For Example: Select “TOOL3” and in the state of SMD Rework System.

When displaying “H-E”, which means the heating element has some malfunction of the rework handle and it needs to check the heater and its circuit.

When displaying “S-E”, which means the sensor has some malfunction of the rework handle and it needs to check the sensor and its circuit.

IX. Care and Maintenance

9.1 Maintenance of the Soldering Iron

9.1.1 Tip's using caution

1. High soldering temperature can degrade the function of the tip and use the tip with the lowest possible soldering temperature. The excellent thermal recovery characteristics ensure efficient and effective soldering event at low temperatures. This also can protect the sensitive components from thermal damage.
2. When using the soldering iron continuously, be sure to loosen the tip and remove all oxides on the tip at least once a week. This helps prevent reducing of the tip temperature.
3. Never keep the soldering iron at high temperature for a long time when not using,. Because the tip will be covered with oxide that can greatly reduce the tip's heat conductivity.
4. Wipe the tip and coat it with fresh solder after using. This helps to prevent tip oxidation.
5. Clean the tip regularly with a cleaning sponge. Oxides and carbides deriving from the solder and the flux can form impurities on the tip. These impurities can result in defective joints or reduce the heating conductivity of the tip.
6. Use fine tips only when necessary. The plating on fine tips is less durable than the plating of the blunter tips.
7. Do not use the tip as a detecting tool. Bending the tip can cause the plating to crack and shorten the tip's life.
8. Use the minimum activation flux necessary to do the job. Higher activation flux is more corrosive to the tip plating.
9. Don't apply pressure to the tip. More pressure does not equal more heat. To improve heat transfer, use solder to form a thermal bridge between the tip and the solder joint.

9.1.2 Check and Clean the Tip

1. Set the temperature to 250°C.

2. When the temperature stabilizes, clean the tip with the cleaning sponge and check the condition of the tip.
3. If there is black oxide on the solder-plated portion of the tip, coat new solder (containing flux) and then wipe the tip on the cleaning sponge. Repeat until the oxide is completely removed and then coat with the new solder.
4. If the tip is deformed or heavily eroded, replace it with a new one.

9.1.3 Renew a de-tinned tip

1. Why does a de-tinned tip fail to work?

A de-tinned tip is one not wetted with solder. This exposes the plating to oxidation and degrades the heat transfer efficiency of the tip.

2. Detinning is caused by:

- (1) Failure to keep the tip coating with fresh solder while not in using.
- (2) High temperatures.
- (3) Insufficient melting in soldering operations.
- (4) Wiping the tip on dirty or dry sponges or rags. (It should use a clean, wet, industrial grade, sulfur-free sponge.)
- (5) There are impurities in the solder, iron plating, or on the surfaces to be soldered.

3. Renew a de-tinned tip

- (1) Remove the tip from the handle after the tip cooling down.
- (2) Remove the dirty and oxides from the tip with 80-grit abrasive polyurethane foam stock or a 100-grit emery.
- (3) Wrap the stannum including rosin (ϕ 0.8mm or larger) around the newly exposed iron surface, insert the tip into the handle, and turn on the power switch.

CAUTION:

- Never file the tip to remove oxide.
- Proper daily care can prevent the tip from de-tinned.

9.1.4 Check and Replace the Soldering Iron

When there is something wrong with soldering iron, you can check and test it. If it is broken, replace the broken element.

9.1.4.1 Check the Soldering Iron

Pull out the plug and measure the resistance value between the pins of the connecting plug when the heating element cooling down to the room temperature.

- (1) If the values of 'a' and 'b' are different from the values in the following table, replace the heating element or sensor or cord assembly. Refer to the following steps.
- (2) If the value of 'c' is over the below value, remove lightly the oxidation in the joint part of the tip and the heat element with sandpaper or steel wool.

a.	Between pins 4&5 (Heating Element)	Under 4 Ω (Normal)
b.	Between pins 1&2 (Sensor)	Under 10 Ω
c.	Between pins 3& Tip	Under 2 Ω

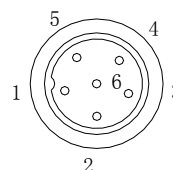

9.1.4.2 Disassembly the Soldering Iron Handle

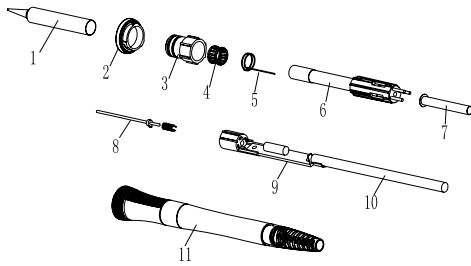

1. Turn the power switch off and disconnect the power plug. Disconnect the handle connector from the station, and disassemble it after it cooling down.
2. Pull out the tip①. Turn anticlockwise the ring② and take it down.
3. Pull out the inlay piece③ towards the tip way.
4. Take out the heater element④ from the iron handle⑪ towards the tip way.
5. Push the handle cord⑩ forward lightly, until the connection cord PCB⑨ has been push out.
6. Don't use metal tools such as pliers to remove the heater element or the tip enclosure from the handle instead of using heat resistant pad.

9.1.4.3 Checking the Heating Element

Measure the heating element when it comes back to room temperature:

1. Resistance value of heating element (cord shield) under 4Ω .
2. Resistance value of sensor (Red and Green wire) under 10Ω .
3. If the resistance value isn't normal, replace the heating element.

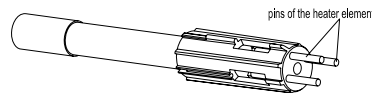

9.1.4.4 Change the Heating Element or the Sensor

1. Measure the resistance values between pin4 and pin1 or pin4 and pin2, between pin5 and pin1 or pin5 and pin2, between pin6 and pin1 or pin6 and pin2, between pin6 and pin4 or pin6 and pin5. If they are not ∞ , the heating element and sensor or vibrator switch are touched. This will damage the PCB.
2. Measure the resistance value 'a', 'b' and 'c' (refer to the above form) to confirm that the leads are not twisted and that the grounding wire is properly connected.
3. Ensure the pins have inserted to the end.

9.1.4.5 Check the Handle Cord of the Soldering Iron

Check the resistance between the pins of the plug and the wires on the terminal. The value should be 0. If it is greater than 0 or is ∞ , the cord should be replaced.

Pin1: Blue

Pin2: Red

Pin3: Green

Pin4: Shielded Conductor

Pin5: Lining of the Shielded Conductor (White)

Pin6: White

9.2 Maintenance and servicing of the De-soldering Gun

Properly maintained, the de-soldering gun should provide years of good service. Efficient de-soldering depends on the temperature, and the quality and quantity of the solder and flux. Perform the following service procedures as indicated by the conditions of the gun's usage.

 **WARNING:**

Since the de-soldering gun can reach a very high temperature, please work carefully. Except when cleaning the nozzle and heating element, always turn the power switch off and disconnect the power plug before performing any maintenance procedure.

9.2.1 Daily maintenance

1. Clean the solder and flux in the suction and the heater element.
2. After cleaning the suction nozzle with the sponge, coat a new solder at its plate to protect the solder plate.
3. The filter is expendable, and it often should be replaced to ensure the suction is normal. Pull out the hose each side filter take out it, replace a new one (refer to the **connection**).

9.2.2 Servicing the de-soldering gun

 **CAUTION:**

The de-soldering gun will be extremely hot. During the maintenance, please wear gloves and work carefully.

1. Inspect and clean the nozzle.
 - (1) Plug in the power cord, turn the power switch on and let the nozzle heat up.
 - (1) Clean out the hole of the nozzle heat up.
 - (2) Check the condition of the solder plating on the tip of the nozzle. If it is slightly worn, recoat the tip with fresh solder to prevent oxidation.
 - (3) Check the condition of the surface and inside hole of the nozzle. If either is worn or eroded, or the inside diameter seems unusually wide, replace the nozzle.

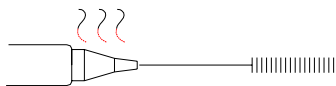

The cleaning pin passes completely through the hole.

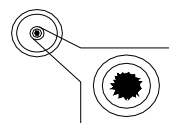

Diameter of hole is widened through erosion.

Note: The cleaning pin will not pass through the nozzle until the solder inside the nozzle is completely melted. Please use the proper sized cleaning pin for the nozzle diameter.

 **CAUTION:**

- Unfortunately, it is often difficult to observe this condition. Therefore, if desoldering efficiency goes down and all other parts run in well, the nozzle is probably eroded and should be replaced.
 - The inside hole and the surface of the nozzle is plated with a special alloy. Should this alloy become eroded by high-temperature solder, the nozzle will not be able to maintain the proper temperature.
2. Disassemble the heating element
Remove the nut with the heat resistant pad.

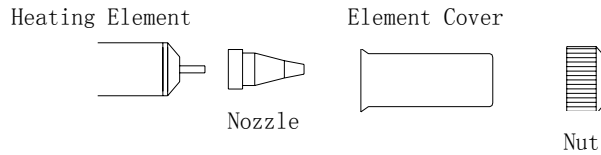

3. Clean out the hole in the heating element with the provided cleaning pin.
Be sure the solder in the hole in the heating element is completely heated before cleaning the hole.

⚠CAUTION: If the cleaning pin cannot pass through the hole, replace the heating element.

4. Replace the filters.

- (1) Turn off the power switch.
- (2) When the filter pipe is cool down to the room temperature and can be touched, push down the release knob at the back of the gun and remove the filter pipe.
- (3) Inspect the front holder: if the front holder is stiff and cracked, replace a new one.
- (4) Inspect the spring filter: the spring filter must replace a new one if it has collected two-part solder.
- (5) Inspect the ceramic paper filter (S) . the ceramic paper filter (S) must replace a new one when it is stiff with flux and solder.

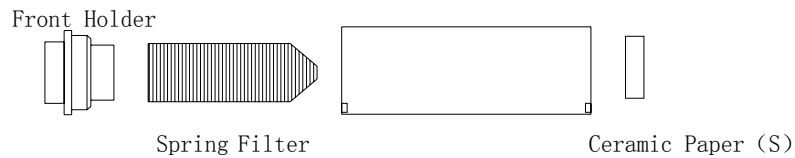

⚠CAUTION:

The filter pip is very hot during the work. The filter change must be done after it has cooled down.

5. Secure the filter

- (1) Attach the spring filter to the front holder.
- (2) Attach the front holder to the filter pipe.

⚠CAUTION:

- Be sure the front holder is correctly aligned.
- Use the ceramic paper filter (S) for the filter pipe (gun). Using of the ceramic paper filter (L) in the filter pipe may cause to break or the power to drop.

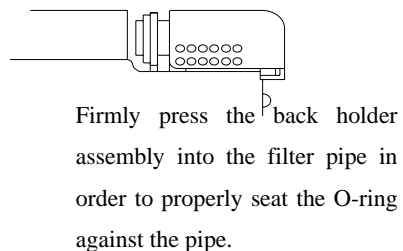
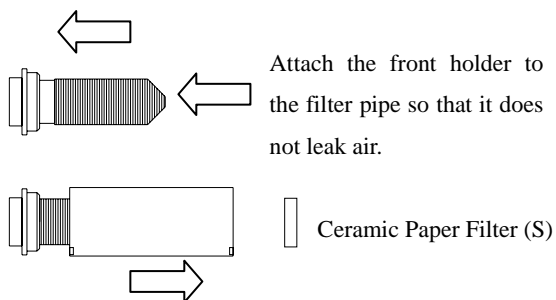

6. Assemble the heater element

Attach the nozzle and securely tighten the nut with the attached heat resistant pad.

 **WARNING:** If the nut is loose, air will leak and the temperature will drop.

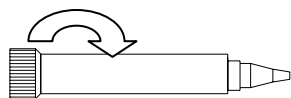

9.2.3 Trouble Shooting Guide of the De-soldering Gun

 **Warning:**

- Disconnect the power plug before servicing. Failure to do so may result in electric shock.
- If the unit is damaged, it must be maintained by the manufacturer, its service agent or similarity qualified person in order to avoid personal injury or damage to the unit.

1. The solder in the junction is not sufficiently melted

Check 1: Temperature is not high enough.

The following parts require a greater heat capacity to de-soldering.

Multi-layer PCB, bilge PCB, frequency modulation of PCB's grounding wire, semiconductor PCB, dual way and three terminals switch part with transmitting heat, big type semiconductor terminal etc.

For the above part, suggest use the PCB pre-heater device. Make the temperature of the PCB heat up to a certain temperature that will not damage the PCB or the other component, after that, de-soldering. Do not only increase the temperature of the gun, otherwise too high temperature may damage the PCB and its components.

Check 2: Nozzle is worn out.

When the nozzle begins to wear out, the heating efficiency begins to decline. Check the nozzle. If the solder plating is damaged, or the nozzle is eroded, replace the nozzle.

2. Suction capability is dropping

Check 1: Replace the filters, and clean the nozzle and the inside of the heating element. Please refer to the "5.5.2".

Check 2: Air is leaking from the vacuum system.

Air leakage cannot be determined from the indicator. Check the air-tightness of the following parts and replace that are worn.

- (1) Contact point of the nozzle and heating.
- (2) Front holder and nearby parts.
- (3) O-ring in the back holder.
- (4) Soft Hose.
- (5) The tie-in of fixing pipe.
- (6) Packing and nearby parts.

Check 3: Clean the nozzle with the clean sponge and then coat a fresh solder on the plating of the nozzle.

3. LED display does not light up.

Check 1: Is the power cord plugged in correctly?

Securely insert the power cord into the power supply with grounding socket.

Check 2: Is the fuse blown?

Determine why the fuse blew and eliminate the cause, then replace the fuse.

- Is the inside of the de-soldering gun short-circuited?
- Is the grounding wire touching the heating element?
- Is the heating element lead twisted and short-circuited?

4. Pump cannot operate.

Check 1: Is the cord assembly properly connected?

Reconnect the cord assembly.

5. Solder cannot be absorbed.

Check 1: Is the spring filter full of solder?

Replace it with a new one.

Check 2: Is the ceramic filter hardened?

Replace it with a new one.

Check 3: Is there a vacuum leak?

Check the connections and replace any worn parts.

Check 4: Is the nozzle or hole in the heating element clogged?

Clean it.

6. The nozzle cannot heat up.

Check 1: Is the de-soldering gun cord assembly properly connected?

Reconnect it.

Check 2: Is the heating element damaged?

Replace it. Measure the heating element whether is broken or not as following.

A	Between pins 4 & 5 (Heating element)	Under 4 Ω (Normal)
B	Between pins 1 & 2 (Sensor)	Under 10 Ω (Normal)
C	Between pins 3&Nozzle	Under 2 Ω

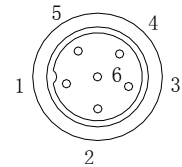

7. Heater error, “H-E” is displayed.

Check 1: Is the de-soldering gun cord broken?

Replace it.

Check 2: Is the heating element broken?

Replace the heating element.

Check 3: Is there a nozzle on the gun?

Assemble a nozzle on the gun.

8. The temperature cannot be set.

Check 1: Is it locked by password?

Enter into the setting password.

9.2.4 Replacing the Heating Element

⚠WARNING: unplug the power cord before starting this procedure.

The resistance value of a working heating element is below 4 Ω . If the value is outside the range, replace the

heating element.

1. Disassemble the heating parts.
2. Separate the housing.
3. Detach the terminal and remove the heating element.
4. Insert a new heating element and reassemble. (Heating element 36V-90W)
5. Recalibrate the temperature.

The resistance of new heating element varies, resulting in variations in operating temperatures. It is necessary to recalibrate the temperature every time the heating element is replaced. (See the Calibrate temperature)

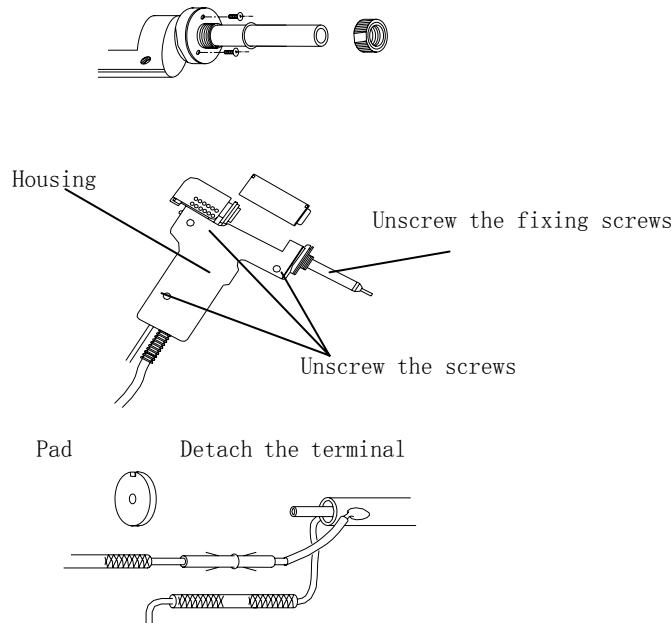

9.3 Parts Assemble and Disassemble of the SMD Rework

9.3.1 Nozzles Assemble and Disassemble

1. Assembly: Select one befitting nozzle and insert it into the outlet's steel pipe. Press it with hand until the nozzle has been locked. It can be used after the nozzle has been fixed reliably.
2. Change: Take the handle down from the holder after the nozzle has cool down. There is a slot between the nozzle and the outlet's steel pipe. By the slot, put the handle on the disassembly plate of the nozzle that is fixed at the holder. After that, fix the holder with one hand and pull out the nozzle. Change another nozzle.

 CAUTION: Change the nozzle after it has cool down.

9.3.2 Replacing Heating Element of the SMD Rework

1. Replace the heating element after the handle has cooled down.
2. Screw down the fixation screws in handle and then take off the handle house.
3. As shown in the diagram, move back the spring in the handle module and take out the steel tube.
4. Cut off the strap, disconnect the sensor cord and the connector, ground cord and ground socket. And then take out the steel tube and the broke heater element.

-
5. Wrap the mica on the new heater element and insert into the steel tube. It is better to right insert into the steel tube and cut off the unwanted mica.

 CAUTION: The sensor cords of heater element putting on the red and yellow hot shrinking tubes are on the opposite part of the ground cord.

6. Reassemble the handle according to the opposite order of disassembling. The heater part of the heater element must be insert into the end. The sensor cord has polarity and it must connect with the same color.

9.4 Replace the Fuse

1. Unplug the power cord from the power receptacle.
2. Remove the fuse holder and take out the broken fuse.
3. Replace the fuse. Put the fuse holder back in place.

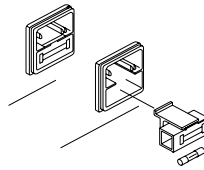

X. Replaceable Parts

10.1 Tips

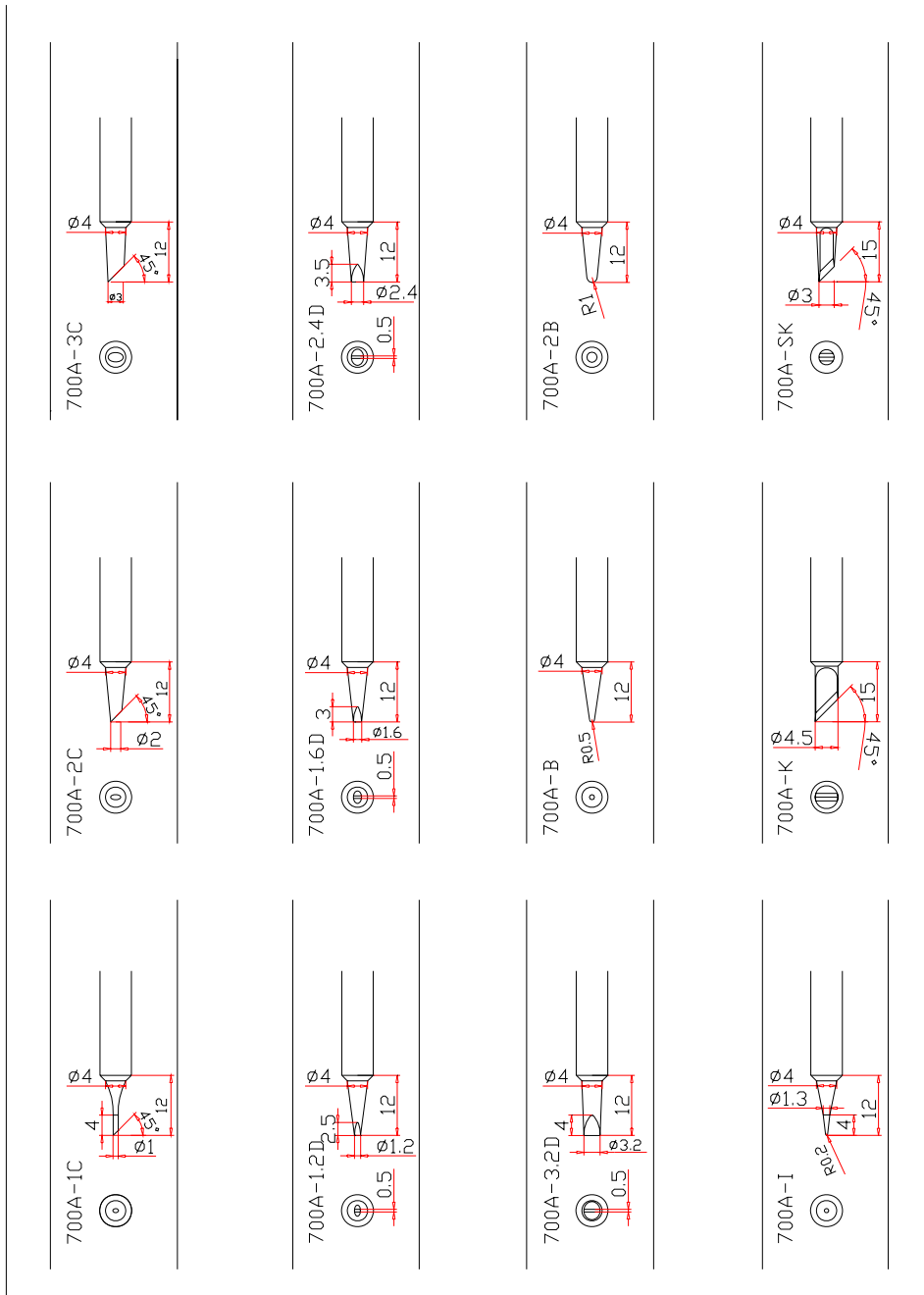

10.2 Sucking Nozzle

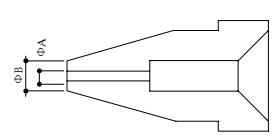
	P/N	ϕ A(mm)	ϕ B(mm)
	A1004	0.8	2.3
	A1005	1.0	2.5
	A1006	1.3	3.0

10.3 NK- SMD Rework Nozzle

NK---SMD Rework Nozzle (direct inserting type)								mm (inch)
<p>NOTE: The size in Name/Specification indicates the size of IC package.</p>								
				QFP	SOP	PLCC	SOJ	BGA
NK3125 QFP 10×10 (0.39×0.39)	NK3126 QFP 14×14 (0.55×0.55)	NK3127 QFP 17.5×17.5 (0.68×0.68)	NK3128 QFP 14×20 (0.55×0.78)	NK3129 QFP 28×28 (1.1×1.1)	NK3131 SOP 4.4×100.17 (0.39×4.1)	NK3132 SOP 5.6×180.22 (0.51×7.1)	NK3133 SOP 7.5×160.3 (0.59×6.3)	
NK3134 SOP 7.5×160.3 (0.73×6.3)	NK3135 PLCC 17.5×17.5 (0.68×0.68) (44 Pins)	NK3136 PLCC 20×20 (0.78×0.78) (52 Pins)	NK3137 PLCC 25×25 (0.98×0.98) (68 Pins)	NK3138 PLCC 30×30 (1.18×1.18) (84 Pins)	NK3139 PLCC 12.5×7.3 (0.49×0.29) (84 Pins)	NK3140 PLCC 11.5×11.5 (0.45×0.45) (28 Pins)	NK3141 PLCC 11.5×14 (0.45×0.55) (32 Pins)	
NK3180 BQFP 17×17 (0.67×0.67)	NK3181 BQFP 19×19 (0.75×0.75)	NK3182 BQFP 24×24 (0.94×0.94)	NK3183 SOJ 15×8 (0.59×0.31)	NK3184 SOJ 18×8 (0.71×0.31)	NK3185 TSQJ 13×10 (0.51×0.39)	NK3186 TSQJ 18×10 (0.71×0.39)	NK3187 TSQJ 18.5×8 (0.73×0.31)	
NK3188 PLCC 9×9 (0.35×0.35) (20 Pins)	NK3189 PLCC 34×34 (1.34×1.34) (100 Pins)	NK3191 SIP 25L (0.98)	NK3192 SIP 50L (1.97)	NK3203 QFP 35×35 (1.38×1.38)	NK3214 SOJ 10×26 (0.39×1.02)	NK3215 QFP 42.5×42.5 (1.67×1.67)	NK3257 SOP 11×21 (0.43×0.83)	
NK3258 SOP 7.6×12.7 (0.3×0.5)	NK3259 SOP 13×28 (0.51×1.1)	NK3260 SOP 8.6×18 (0.34×0.71)	NK3261 QFP 20×20 (0.78×0.78)	NK3262 QFP 12×12 (0.47×0.47)	NK3263 QFP 28×40 (1.1×1.57)	NK3264 QFP 40×40 (1.57×1.57)		
NK3265 QFP 32×32 (1.26×1.26)	NK2064 Single =6.4 (0.25)	NK2084 Single =8.4 (0.33)	NK2127 Single =12.7 (0.5)	NK1120 Single =4 (0.16)	NK1124 Single =2.5 (0.09)	NK1130 Single =4.4 (0.17)		
NK2280 BGA 24×24 (0.94×0.94)	NK2281 BGA 26×26 (1.02×1.02)	NK2282 BGA 31×31 (1.22×1.22)	NK2283 BGA 38×38 (1.5×1.5)	NK2284 BGA 41×41 (1.6×1.6)	NK2285 BGA 44×44 (1.7×1.7)	NK2286 BGA 15×15 (0.6×0.6)		