

<b>Chapter1 General Introduction</b> .....	1
<b>1.1 Function Features</b> .....	1
<b>1.2 Front Panel</b> .....	2
<b>1.3 Rear Panel</b> .....	2
<b>1.4 Keypad Function</b> .....	3
<b>1.5 Annunciators</b> .....	4
<b>1.6 Menu</b> .....	4
<b>1.6.1 Main Menu</b> .....	4
<b>1.6.2 Mode Selection and Parameter Setting Menu</b> .....	5
<b>1.6.3 Transient Operation Menu</b> .....	6
<b>1.6.4 List Operation Menu</b> .....	6
<b>1.7 Display Messages</b> .....	6
<b>1.8 Remote Programming</b> .....	9
<b>Chapter2 Functions and Features</b> .....	10
<b>2.1 Local and Remote Control</b> .....	10
<b>2.2 Main Functions:</b> .....	10
<b>2.3 Basic Test Functions</b> .....	10
<b>2.3.1 Constant Current Mode</b> .....	11
<b>2.3.1.1 Setting Ranges</b> .....	11
<b>2.3.1.2 Immediate Current Level</b> .....	12
<b>2.3.1.3 Triggered Current Level</b> .....	12
<b>2.3.1.4 Transient Current Level</b> .....	12
<b>2.3.1.5 Software Current Limit</b> .....	12
<b>2.3.2 Constant Voltage Mode (CV)</b> .....	12
<b>2.3.2.1 Setting Ranges</b> .....	13
<b>2.3.2.2 Immediate Voltage Level</b> .....	13
<b>2.3.2.3 Triggered Voltage Level</b> .....	13
<b>2.3.2.4 Transient Voltage Level</b> .....	13
<b>2.3.3 Constant Resistance Mode (CR)</b> .....	13
<b>2.3.3.1 Setting Ranges</b> .....	14
<b>2.3.3.2 Immediate Resistance Level</b> .....	14
<b>2.3.3.3 Triggered Resistance Level</b> .....	14
<b>2.3.3.4 Transient Resistance Level</b> .....	15
<b>2.3.4 Constant Power Mode (CP)</b> .....	15
<b>2.3.4.1 Setting Ranges</b> .....	16
<b>2.3.4.2 Immediate Power Level</b> .....	16
<b>2.3.4.3 Triggered Power Level</b> .....	16
<b>2.4 Transient Operation</b> .....	17
<b>2.4.1 Continuous Transient Operation</b> .....	17
<b>2.4.2 Pulsed Transient Operation</b> .....	18
<b>2.4.3 Toggled Transient Mode</b> .....	20
<b>2.5 List Operation</b> .....	21
<b>2.6 Battery Discharge Operation</b> .....	22
<b>2.7 Short Circuit Operation</b> .....	23

2.8 Triggered Operation.....	23
2.9 Input Control.....	24
2.9.1 Turning On/Off the Load.....	24
2.9.2 Von Point/Von Latch.....	25
2.9.3 Current Limit in CV Mode.....	26
2.9.4 Current Rise Rate.....	26
2.9.5 Current Fall Rate.....	26
2.10 Measurement Function.....	27
2.11 Saving and Recalling.....	27
2.12 Reading Remote Programming Errors.....	28
2.13 Status Report.....	29
2.14 Protection Function.....	29
2.14.1 Clearing Latched Protection.....	29
2.14.2 Overvoltage.....	30
2.14.3 Overcurrent.....	30
2.14.4 Overpower.....	30
2.14.5 Overtemperature.....	30
2.14.6 Reverse Voltage.....	30
2.15 Auxiliary Functions.....	30
2.15.1 Trigger Function Selection.....	30
2.15.2 Knob Function.....	31
2.15.3 Key Sound.....	31
Chapter3 Installation.....	31
3.1 Initial Check.....	31
3.2 Environment/Installation Location.....	31
3.3 Power-On/ Self-Test.....	31
3.4 Connections on the Rear Panel.....	32
3.5 Connections on the Front Panel.....	33
3.6 Wiring.....	34
Chapter 4 Local Operation.....	35
4.1 Local Control.....	35
4.2 Main Operation on the Front Panel.....	35
4.3 Connecting to the Power Supply.....	35
4.4 Turning the Input On/Off.....	36
4.5 Basic Operation.....	36
4.5.1 CC Mode.....	36
4.5.2 CV Mode.....	38
4.5.3 CR Mode.....	39
4.5.4 CP Mode.....	41
4.6 Short Circuit Operation.....	42
4.7 Transient Operation.....	43
4.7.1 Continuous Transient Operation.....	44
4.7.2 Pulsed Transient Operation.....	46
4.7.3 Toggled Transient Operation.....	47

4.8 List Operation.....	49
4.8.1 List Editing.....	50
4.8.2 Modifying, Adding, Inserting, Deleting the List.....	52
4.8.3 Starting/Stopping the List.....	54
4.9 Battery Discharge Operation.....	55
4.10 Saving and Recalling.....	56
4.11 Clearing Protection Settings.....	57
4.12 Error Messages.....	58
4.13 Triggered Operation.....	58
4.14 Main Menu.....	59
4.14.1 Loading Default Values.....	59
4.14.2 Short Circuit Operation.....	59
4.14.3 Von Point/Von Latch.....	60
4.14.4 Current Limit in CV Mode.....	60
4.14.5 Current Rise/Fall Rate in CC Mode.....	61
4.14.6 Trigger Function Selection.....	62
4.14.7 Knob Function.....	62
4.14.8 Key Sound.....	62
4.14.9 Communication Interface.....	63
<b>Chapter5 Remote Programming Operation.....</b>	<b>64</b>
<b>5.1 Communication Interface.....</b>	<b>64</b>
5.1.1 RS232.....	64
5.1.2 USB.....	64
5.1.3 GPIB.....	65
5.2 Flow Control Selection.....	65
5.3 Remote Control Annunciators.....	65
5.4 Sending a Remote Command.....	65
5.5 Returning Data.....	65
5.6 Remote Programming Commands.....	65
5.6.1 Modes.....	65
5.6.2 Transient Levels.....	66
5.6.3 Programmable Current Protection.....	66
5.8 CV Mode Examples.....	66
5.9 CR Mode Examples.....	66
5.10 Continuous Transient Operation Example.....	66
5.11 Pulsed Transient Operation Example.....	67
<b>Specifications.....</b>	<b>67</b>

# Chapter1 General Introduction

ARRAY 372x Series programmable electronic load, as a new generation of product developed by ARRAY Electronic Co., Ltd., is designed with high performance. It provides you powerful test function, user-friendly HMI, as well as RS232, USB, GPIB interfaces to support SCPI and Labview. 372x Series is widely used in scientific research and production fields such as aerospace, shipbuilding, automotive electronics, solar cell, and fuel cell.

All “electronic load” and “load” appear in this manual refer to ARRAY 372x Series Electronic Load if there is no special explanation.

## 1.1 Function Features

Main functions and features of ARRAY372x Series:

- 4 basic test functions: CC,CV, CR, and CP; 8 basic operating modes: CCL, CCH, CV, CRL, CRM, CRH, CPV, CPC;
- The 24 bits A/D and 17 bits D/A converters incorporated, provide this equipment with greatly enhanced setting and measurement resolution. 100kHz D/A conversion rate fully improves high-speed performance;
- Minimum operating voltage is less than 0.6V at the load’s full rated current (3720/3721). With optional low-voltage testing devices, the maximum current can be achieved even though the input voltage is 0V. This is especially suitable for fuel cell, solar cell and other new energy test applications;
- Perfect protection assures high reliability in the most complicated test environments;
- Innovative design of CPV and CPC modes effectively improves the practicability of CP mode;
- Circuit improvement greatly enhances the dynamic response of CR mode and widens the application scope of that mode;
- High-speed transient operation with a maximum test frequency of 50kHz;
- Powerful sequential test function; with a minimum step time of 10us; and a maximum step time of 10000s. Cyclic numbers can be adjusted freely and a sequence can be chained to another sequence to achieve even more complex test procedures;
- The input binding posts with their innovative design are especially suitable for large current testing;
- Provides short-circuit test, battery discharge test and other auxiliary functions;
- A high-efficiency, intelligent cooling system can effectively reduce system temperature and enhance power density;
- Automatic ON/OFF function simplifies test operation;
- Knobs and digital keypad makes the operation more convenient;
- Save/recall function can save multiple groups of general settings;
- Supports SCPI (Standard Commands for Programmable Instrumentation) and Labview, and provides necessary PC software;

## 1.2 Front Panel

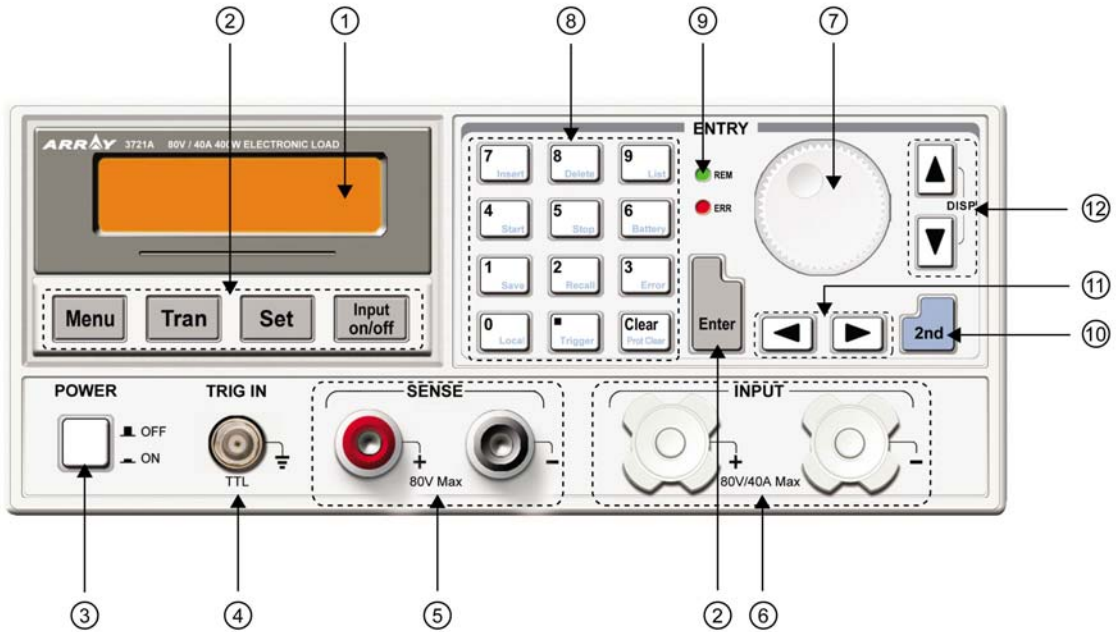

Fig. 1-1 Front Panel

- ① LCD    ② Function key    ③ Power switch    ④ External trigger input terminal    ⑤ Remote sense terminal    ⑥ Input binding posts    ⑦ Knob    ⑧ Entry keys/secondary function keys    ⑨ Annunciators    ⑩ Switch key for secondary function    ⑪ Left&Right key    ⑫ Up & Down key/Display-switching key

## 1.3 Rear Panel

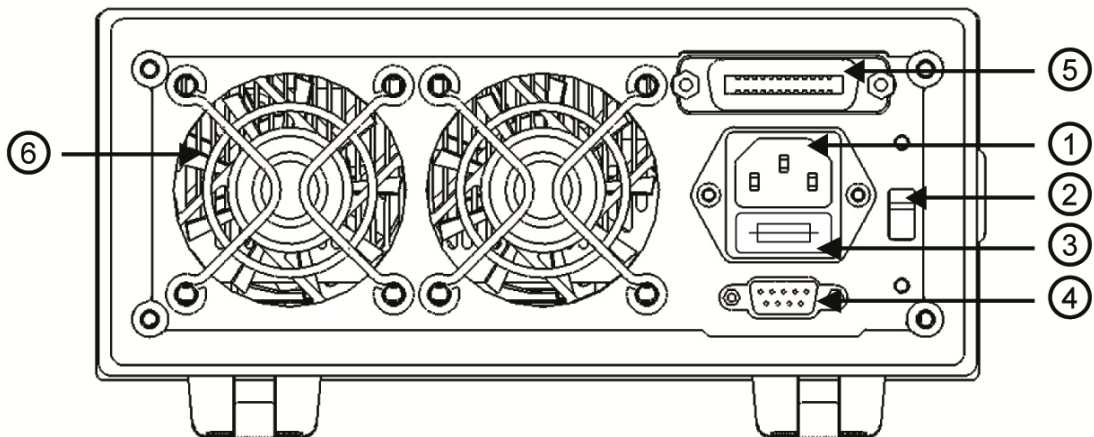





















Fig1-2 Rear Panel





- ① AC input socket    ② Line voltage switch    ③ Fuse holder    ④ RS232 Interface    ⑤ GPIB or USB (optional)    ⑥ Air outlet

## 1.4 Keypad Function

There are three groups of keypads on the front panel: the Function Keys, the Entry Keys, which composite with secondary functions, and the Direction Keys. The secondary functions of the Entry Keys are printed in blue. To use the secondary function, please press  key first, then press the relevant key.



List 1-1 Description for Keys

	0/Local key
	1/Save key
	2/Recall key
	3/Error code display key
	4/List start key
	5/List stop key
	6/Battery discharge operation key
	7/Insert key
	8/Delete key
	9/ List operation key
	Decimal point/Trigger key
	Clear or exit /Clear protection
	Main Menu
	Transient operation menu
	Set key
	Input on/off
	Confirm key
	Left key

	Right key
	Up key
	Down key
	Switch key for secondary function

Note: Up and Down key can be used as a switch key for displaying load status and actual power during basic operating modes.

## 1.5 Annunciators

 REM	Indicates that the electronic load is in remote status.
 ERR	Indicates that a remote programming error has occurred.



## 1.6 Menu

### 1.6.1 Main Menu

Press  key to enter into main menu. Please see the list below for main menu content:

Function and Parameter	Description
Load Default Yes *No	Restore default Yes No
Short On *Off	Short circuit mode On Off
Von Latch On *Off	Von latch On Off
Von Point 0.000v	Set Von voltage point Von point
CV Curr Limit 40.00A	Current limit in CV mode Current limit
Curr Rise Rate 4.000A/us	Current rise rate in CC mode Current rise rate
Curr Fall Rate 4.000A/us	Current fall rate in CC mode Current fall rate
Trig Function *Tran List	Trigger function selection Transient test Sequence (list) test
Knob *On Off	Enable/disable knob function On Off
Key Sound *On Off	Enable/disable key sound On Off
Interface *RS232 USB GPIB	Remote interface selection RS232 USB GPIB

<b>RS232 Interface</b>	Baud Rate 2400 4800 *9600 19200 38400	Baud rate setting 2400 4800 9600 19200 38400
	Parity Check *None Even Odd	Parity check setting None Even Odd
	Data Bit *8 7	Data bits length 8bits 7bits
	Stop Bit *1 2	Stop bit length 1bit 2bits
	Flow Control *On Off	Enable/disable Flow control On Off
<b>USB Interface</b>		USB selection
<b>GPIB Interface</b>	GPIB Address 5	GPIB address Address value

Note: Except knob, key sound and interface configurations, the other parameters in main menu will not be saved when the load is turned off. If it is needed to save the parameters, please use  key +  key or \*sav command. When the load is turned on next time, the saved parameters in location 0 will be recalled automatically.

## 1.6.2 Mode Selection and Parameter Setting Menu

Press  key to enter into mode selection and parameter setting menu, which is shown as below:

Function and Parameter	Description
MODE: CCL CURR: 0.000A	Constant current low range Immediate current level
MODE: CCH CURR: 0.000A	Constant current high range Immediate current level
MODE: CV VOLT: 80.00V	Constant voltage mode Immediate voltage level
MODE: CRL RES: 2.000 $\Omega$	Constant resistance low range Immediate resistance level
MODE: CRM RES: 20.000 $\Omega$	Constant resistance medium range Immediate resistance level
MODE: CRH RES: 20.000 $\Omega$	Constant resistance high range Immediate resistance level
MODE: CPV POWR: 0.000W	Constant power-voltage source mode Immediate power level
MODE: CPC POWR: 0.000W	Constant power-current source mode Immediate power level



### 1.6.3 Transient Operation Menu

Press **Tran** key in desired mode to enable its transient operation, and press **Set** key to enter into transient setting menu, which is shown as below:

Function	Description	Example
LevelL	Transient low level	1.000A
LevelH	Transient high level	2.000A
TimeL	Time for transient low level	600.00ms
TimeH	Time for transient high level	600.00ms
TimeR	Time for transient rising edge	0.01ms
TimeF	Time for transient falling edge	0.01ms
MODE	Continuous (Cont) Pulse (Puls) Toggle (Togg)	Cont

Note: Transient operation may be used in CC, CV, and CR modes.

### 1.6.4 List Operation Menu

Press **2nd** key + **9 List** key to enter into the list operation menu, which is shown as below:

Function	Description
No.	Select sequence (list) number (0-6)
Memo	Sequence memo (10 characters)
Data: <New/Edit>	Create a new or edit an existing sequence
Count	Cycle times (1-65535)
Chain: Off	Sequence number to be chained with (0-6, off)

Press **▲** and **▼** keys in list operation menu to select Data: <New/Edit>, and select New or

Edit with the knob or **◀** and **▶** keys. Then press **Enter** key to enter into sequence data editing status, which is shown as below:

Function	Description
01. 10000.00000s CCH 5.000A	Sequence (List) number Time Mode Set value

### 1.7 Display Messages

① CC Mode:

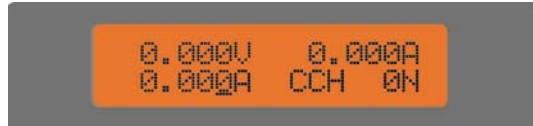

The first line shows measured voltage and current levels. The second line shows current set level, CC mode (CCH indicates constant current high range; CCL indicates constant current low range) and input status of the load: (ON, OFF).

② CV Mode:



The first line shows measured voltage and current levels. The second line shows voltage set level, CV mode, and input status of the load: (ON, OFF).

③ CR Mode:

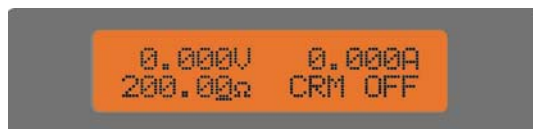
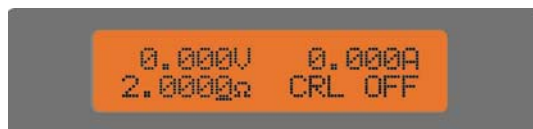

The first line shows measured voltage and current levels. The second line shows resistance level, CR mode (CRL indicates constant resistance low range; CRM indicates constant resistance medium range; and CRH indicates constant resistance high range) and input status of the load: (ON, OFF).

④ CP Mode:

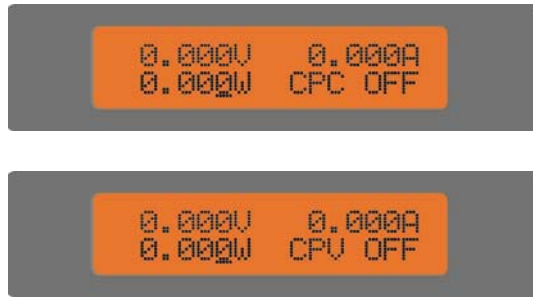

The first line shows measured voltage and current levels. The second line shows power set level, CP mode (CPC indicates constant power-current source mode; CPV indicates constant power-voltage source mode), and input status of the load: (ON, OFF).

⑤ Transient Operation:



The first line shows measured voltage and current levels. The second line shows set level, transient operation mode (tCCH indicates high current mode transient operation; tCCL indicates low current mode transient operation; tCV indicates constant voltage mode transient operation; tCRL indicates low resistance mode transient operation; tCRM indicate medium resistance mode transient operation and tCRH indicates high resistance mode transient operation. “t” indicates transient operation), and input status of the load: (ON, OFF).

⑥ List Operation:



The first line shows measured voltage and current levels. The second line shows set level, sequence operation mode (lCCH indicates high current mode list operation; lCCL indicates low current mode list operation; lCV indicates constant voltage mode list operation; lCRL indicates low resistance mode list operation; lCRM indicate medium resistance mode list operation and lCRH indicates high resistance mode list operation. “L” indicates list test; and input status of the load: (ON, OFF).

⑦ Battery Discharge Operation:



The first line shows measured voltage and current levels. The second line shows battery capacity and discharge time.



⑧ Short Circuit Operation:

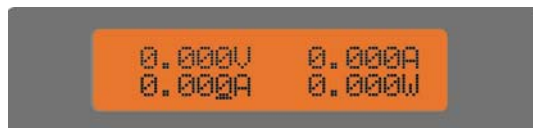

The first line shows measured voltage and current levels. The second line shows set level in short circuit (Take 3721A as an example, short circuit test current in CCL is 4.4A; short circuit test current in CCH is 44A; short circuit test voltage in CV is 0V; short circuit test resistance in CRL is  $0.018\ \Omega$ ; short circuit test resistance in CRM is  $1.8\ \Omega$ ; short circuit test resistance in CRH is  $18\ \Omega$ ; short circuit test power in CPV is 420W; short circuit test power in CPC is 0W), short circuit operation mode (sCCL, sCCH, sCV, sCRL, sCRM, sCRH, sCPC, sCPV; “s” indicates short circuit test), and input status of the load (ON, OFF).

⑨ Display Actual Power:



Pressing  and  key can switch the display of load status and actual power. On the display screen of actual power, the first line shows actual voltage and current; the second line shows set level and actual power level.

⑩ Protection Status

If the protection function is active, LCD will display corresponding protection status. For example: the display of reverse voltage protection status is shown as below:

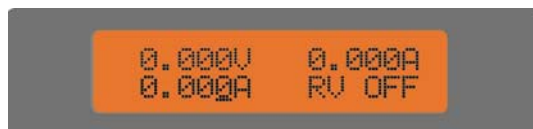

Protection status includes overcurrent (OC), overvoltage (OV), overpower (OP), over temperature (OT), load protection (PT), and reverse voltage (RV).

## 1.8 Remote Programming





The commands are sent to electronic load via remote interface (RS232, GPIB, USB), and will be executed after decoding by the processor. If there is any error occurs to the command, the processor can detect the wrong command and error type, and it can maintain the status register as well.

## Chapter2 Functions and Features

The functions and features of electronic load will be described in this chapter, which helps you to know ARRAY 372x Series better.

### 2.1 Local and Remote Control

ARRAY 372x Series electronic load can be controlled via the keypad and knobs in the front panel, or by remote controller via remote interface. If it is needed to control the load via the front panel, the load has to stay in local control status. Local (front panel) control is in effect immediately after power is applied. The REM annunciator is turned on, and remote control goes into effect as soon as the load receives a SYSTem:REMote command via RS232, USB or GPIB.

Under remote control status, all operations on front panel keypad and knobs become invalid (except  key +  key ). All operations on electronic load are controlled by remote controller. The electronic load will return to local control and REM remote control annunciator is turned off after receiving the return command( SYSTem:LOCAl). Or you can return the electronic load to local control by pressing  key +  key

Details of local operation are covered in *Chapter 4 “Local Operation”* and fundamentals of remote programming are given in *Chapter 5 “Remote Operation”*. Complete SCPI programming details are given in the *ARRAY 372x Series Electronic Load SCPI Programming Guide*.

### 2.2 Main Functions:

- CC(constant current) Mode: CCL, CCH
- CV(constant voltage) Mode: CV
- CR(constant resistance) Mode: CRL, CRM, CRH
- CP(constant power) Mode: CPV, CPC
- Transient Operation: Tran
- List Operation: LIST
- Battery Discharge Operation: BATTERY
- Short Circuit Operation (Short)

### 2.3 Basic Test Functions

There are four basic test functions: constant current (CC), constant voltage (CV), constant resistance

(CR), constant power (CP) and eight basic operating modes: CCL, CCH, CV, CRL, CRM, CRH, CPV and CPC.

The operating mode and the associated parameters can be set via front panel or remote command. The load will remain in current mode until the mode is changed. If the mode is changed when the load's input is in ON status, the load will be turned off for around 5ms automatically.

The set value for electronic load becomes effective immediately when the load is turned on. If the input set value exceeds the allowed range, it will be automatically limited at maximum value or minimum value.

### 2.3.1 Constant Current Mode

Constant current mode has two ranges, the high range (CCH) and the low range (CCL). The high range provides wider test range. The low range provides better resolution at low current settings. In CC mode, the load will sink a constant current in accordance with the programmed value regardless of the change of input voltage (see Fig.2-1). Press **Set** key in basic mode to enter into

mode selection and parameter setting menu. Choose CCH or CCL mode with **▲** and **▼** keys.

Input the current level via the Entry keys or the knob with **◀** and **▶** keys. Use **Enter** key for confirmation. The CC mode and parameters can also be set via remote command (MODE CCL, MODE CCH, CURRent <NRf+>).

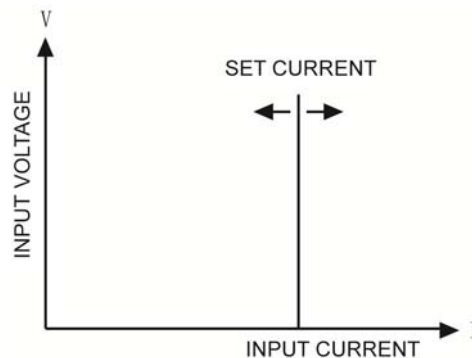

Fig.2-1 CC Mode



#### 2.3.1.1 Setting Ranges

The setting ranges for different models of load are listed as follows:

	Model	3720A	3721A	3722A	3723A	3724A
Mode	CCL	0~3A	0~40A	0~2A	0~3A	0~2A
	CCH	0~30A	0~40A	0~20A	0~30A	0~20A

If the range is changed in CC mode while the load's input stays in ON status, the load will be turned off for around 5ms automatically. For example: when the load is switched from CCL to CCH, the input will be turned off around 5ms. Besides, it is noted that the current set level may change with the current level to fit the new range. Take 3721A as an example, the present setting is CCH 10.000A, when the load is switched from CCH to CCL, the current set level will change to the maximum level 4.0000A for CCL.

### 2.3.1.2 Immediate Current Level

The immediate current level refers to the current set value in CC mode, which can be programmed via mode selection and parameter setting menu, or via remote command (CRRRent <NRf+>). The immediate current level can also be modified directly with left/right keys ( ) and the knob.

### 2.3.1.3 Triggered Current Level

The triggered current level refers to the preset current value, which can become immediate current level automatically when a trigger is received. If the CC mode and the input are enabled, the input will be updated immediately when a trigger occurs. If the CC mode is not active, this current level will have no effect on the input until the CC mode becomes active.

The triggered current level only can be set via remote command (CURRENT:TRIGgered <NRf+>). Once a current level is triggered, subsequent triggers will become invalid until another (CURRENT:TRIGgered <NRf+>) command is received. The trigger operation will be described in later chapter. The status register of the electronic load can keep track of pending triggers and other operating conditions, which will be described in details in the “ARRAY 372x Series Electronic Load SCPI Programming Guide”.

### 2.3.1.4 Transient Current Level

The load will switch between the transient high current level (LevelH) and transient low current level (LevelL) when the transient operation is enabled. The transient current level can be set in transient operation menu from the front panel, or via remote command (CURRENT:HIGH <NRf+>, CURRENT:LOW <NRf+>).







### 2.3.1.5 Software Current Limit

The electronic load allows the user to set a current limit (the current range is the same as that in CCH mode ) via remote command. The load will be turned off with beeping alarms if the current limit is exceeded beyond a programmable time delay (0.001-60s). Please note that the software current limit is in effect for any mode of operation. Remote commands are listed as follows:

CURRENT:PROTection <NRf+>

CURRENT:PROTection:DELAy <NRf+>

### 2.3.2 Constant Voltage Mode (CV)

In CV mode, the load will attempt to sink enough current to control the source voltage to the programmed constant value regardless of the change of input current. (see Fig.2-2). Press  key in basic mode to enter into mode selection and parameter setting menu. Choose CV mode with  and  keys. Input the voltage value via the Entry keys or the knob with  and  keys. Use  key for confirmation. The CV mode and parameters can also be set via remote command (MODE CV, VOLTage <NRf+>).

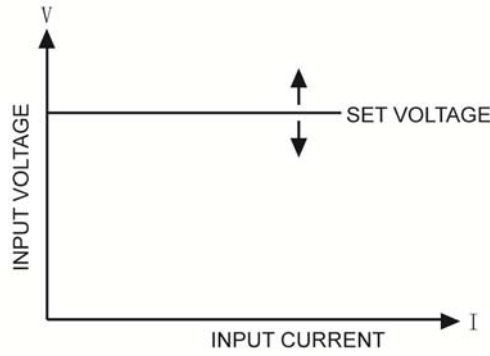

Fig.2-2 CV Mode

### 2.3.2.1 Setting Ranges

The voltage setting ranges for different models of load are listed as follows:

Model	3720A	3721A	3722A	3723A	3724A
Voltage	0~80V	0~80V	0~200V	0~200V	0~500V

### 2.3.2.2 Immediate Voltage Level

The immediate voltage level refers to the voltage set value in CV mode, which can be set via mode selection and parameter setting menu, or via remote command (VOLTage <NRf+>). The immediate current level can also be modified directly with left/right keys (◀ ▶) and the knob in CV mode.

### 2.3.2.3 Triggered Voltage Level

The triggered voltage level refers to the preset voltage value, which can become immediate voltage level automatically when a trigger is received. If the CV mode and the input are enabled, the input will be updated immediately when a trigger occurs. If the CV mode is not active, this voltage level will have no effect on the input until the CV mode is active.

The triggered voltage level only can be set via remote command (VOLTage:TRIGgered <NRf+>). Once a voltage level is triggered, subsequent triggers will become invalid until another (VOLTage:TRIGgered <NRf+>) command is received. The trigger operation will be described in later chapter. The status register of the electronic load can keep track of pending triggers and other operating conditions, which will be described in details in the “ARRAY 372x Series Electronic Load SCPI Programming Guide”.

### 2.3.2.4 Transient Voltage Level

The load will switch between the transient high voltage level (LevelH) and transient low voltage level (LevelL) when the transient operation is enabled. The transient voltage level can be set in transient operation menu from the front panel, or via remote command (VOLTage:HIGH <NRf+>, VOLTage:LOW<NRf+>).

### 2.3.3 Constant Resistance Mode (CR)

Constant resistance mode has three ranges: the low range (CRL), the medium range (CRM), and the high range (CRH). In CR mode, the load is equivalent to a constant resistance and will sink a current linearly proportional to the input voltage in accordance with the programmed resistance to make



$I=U/R$  (see Fig.2-3). Press **Set** key in basic mode to enter into mode selection and parameter setting menu. Choose CR mode with **▲** and **▼** keys. Input the resistance value via the Entry keys or the knob with **◀** and **▶** keys. Use **Enter** key for confirmation. The CR mode and parameters can also be set via remote command (MODE CRL, MODE CRM, MODE CRH, RESistance <NRf+>).

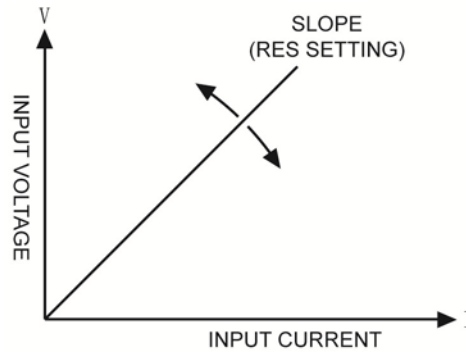

Fig.2-3 CR Mode

### 2.3.3.1 Setting Ranges

The setting ranges for different models of load are listed as follows:

	Model	3720A	3721A	3722A	3723A	3724A
Mode	CRL	0.02~2 Ω	0.02~2 Ω	0.0666~6.66 Ω	0.0666~6.66 Ω	0.125~12.5 Ω
	CRM	2~200 Ω	2~200 Ω	6.66~666 Ω	6.66~666 Ω	12.5~1250 Ω
	CRH	20~200 Ω	20~200 Ω	66.6~6660 Ω	66.6~6660 Ω	125~12500 Ω

If the range is changed in CR mode while the load's input stays in ON status, the load will be turned off for around 5ms automatically. For example: when the load is switched from CRL to CRH, the input will be turned off around 5ms. Besides, it is noted that the resistance set level may change with the resistance range to fit the new range. Take 3721A for example, the present setting is CRM 10.000 Ω, when the load is switched from CRM to CRL, the resistance set level will change to the maximum level 2.0000 Ω for CRL.

### 2.3.3.2 Immediate Resistance Level

The immediate resistance level refers to the resistance set value in CR mode, which can be set via mode selection and parameter setting menu, or via remote command (RESistance <NRf+>). The immediate resistance level can also be modified directly with left/right keys (**◀** **▶**) and the knob in CR mode.

### 2.3.3.3 Triggered Resistance Level

The triggered resistance level refers to the preset resistance value, which can become immediate resistance level automatically when a trigger is received. If the CR mode and the input are enabled, the input will be updated immediately when a trigger occurs. If the CR mode is not active, this resistance

level will have no effect on the input until the CR mode becomes active.

The triggered resistance level only can be set via remote command (RESistance:TRIGgered <NRf+>). Once a resistance level is triggered, subsequent triggers will become invalid until another (RESistance:TRIGgered <NRf+>) command is received. The trigger operation will be described in later chapter. The status register of the electronic load can keep track of pending triggers and other operating conditions, which will be described in details in the “ARRAY 372x Series Electronic Load SCPI Programming Guide”.

#### 2.3.3.4 Transient Resistance Level

The load will switch between the transient high resistance level (LevelH) and transient low resistance level (LevelL) when the transient operation is enabled. The transient resistance level can be set in transient operation menu from the front panel, or via remote command (RESistance:HIGH<NRf+>, RESistance:LOW <NRf+>).

#### 2.3.4 Constant Power Mode (CP)

There are two sorts of constant power modes, the Constant Power-Voltage Source mode (CPV) and the Constant Power-Current Source mode (CPC). The CPV mode is applied to voltage source test, and the CPC mode is applied to current source test. In CP mode, the load consumes the constant power in accordance with the programmed value regardless of the changes of external current and voltage (see Fig.2-4). Press  key to enter into mode selection and parameter setting menu. Choose CPV or CPC mode with  and  keys. Input the power value via Entry keys or the knob with  and  keys. Use  key for confirmation. The CP mode and parameters can also be set via remote command (MODE CPV, MODE CPC, POWER <NRf+>).

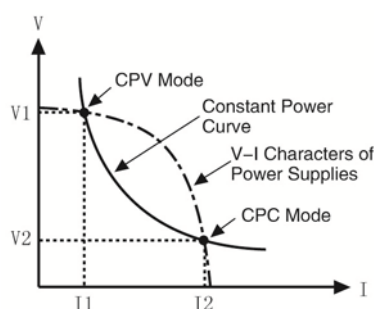

Fig.2-4 CP Mode

Figure 2~5 are the current-voltage curves for several common power supplies. The constant power curve is a hyperbola in the first quadrant. The constant power curve usually intersects with current-voltage curve at two points (the CPV point and the CPC point) when the power of the external power supply is larger than the set power. At the CPV point, the power supply shows the feature of voltage source: the output power will be increased with increasing current; at the CPC point, the power supply shows the feature of current source: the output power will be increased with increasing voltage. Array 372x series electronic load can be set at any one of intersection points to operate by the user.

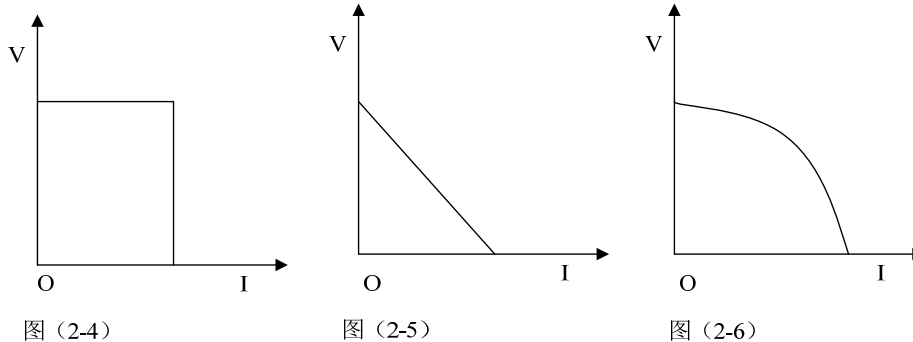

Fig. 2-5 Current-voltage Curve for Normal Power Supply

As adopting advanced slope detection method, Array 372x Series electronic load only need to test a part of the current-voltage curve to know whether the two curves (constant power curve and current-voltage curve) intersect. Therefore, when the set power is larger than the actual power, the external power supply will not be short-circuited by the load for the insufficient power. When the load detects that the power of the external power supply is insufficient, it will try to find constant power point automatically till the set power is met.

#### 2.3.4.1 Setting Ranges

The setting ranges for different models of load are listed as follows:

Model	3720A	3721A	3722A	3723A	3724A
Power	0~250W	0~400W	0~200W	0~350W	0~250W

#### 2.3.4.2 Immediate Power Level

The immediate power level refers to the power set value in CP mode, which can be set via mode selection and parameter setting menu, or via remote command (POWER <NRf+>). The immediate resistance level can also be modified directly with left/right keys (◀ ▶) and the knob.

#### 2.3.4.3 Triggered Power Level

The triggered power level refers to the preset power value, which can become immediate power level automatically when a trigger is received. If the CP mode and the input are enabled, the input will be updated immediately when a trigger occurs. If the CP mode is not active, this power level will have no effect on the input until the CP mode becomes active.

The triggered power level only can be set via remote command (POWER:TRIGgered <NRf+>). Once a power level is triggered, subsequent triggers will become invalid until another (POWER:TRIGgered <NRf+>) command is received. The trigger operation will be described in later chapter. The status register of the electronic load can keep track of pending triggers and other operating conditions, which will be described in details in the “ARRAY 372x Series Electronic Load SCPI Programming Guide”.

## 2.4 Transient Operation

When the transient operation is enabled, the load periodically switch between two levels (LevelH and LevelL), which can be applied to test the dynamic characteristics of the power supply. The transient operation can be executed in the CC, CV and CR modes, and has three operating statuses: Continuous, Pulsed, and Toggled. Please make sure the List Operation has been disabled before enabling transient operation.

The parameters associated with transient operation are: low level (LevelL), high level (LevelH), low level time (TimeL), high level time (TimeH), time for rising edge (TimeR), time for falling edge (TimeF), and operating mode.

Transient high/low level and corresponding CC, CV and CR modes share the same setting ranges.

The range for high/low level time is 0 ~ 655.35ms; the range for rising/falling edge time is 10us ~ 655.35ms; the time resolution is 10us, and the maximum test frequency is 50kHz.

Transient test can be turned on and off via  key at the front panel or via remote command (TRANSient ON/OFF). Before you turn on transient test, you should set the load to the operating mode that needs transient test.

Note: In transient test, the Von point and current limit should be taken into consideration, which may cause the shut down of the input, thus interrupt the transient test.

### 2.4.1 Continuous Transient Operation

In continuous operation, the load periodically switches between high/low levels, and this operation is not affected by the trigger signal. The relevant parameters such as low level (LevelL), high level (LevelH), low level time (TimeL), high level time (TimeH), time for rising edge (TimeR), time for falling edge (TimeF), and continuous transient operation can be set through transient operation menu or via remote command (CURRENT:LLEVel <NRf+>, CURRENT:HLEVel <NRf+>, VOLTage:LLEVel <NRf+>, VOLTage:HLEVel <NRf+>, RESistance:LLEVel <NRf+>, RESistance:HLEVel <NRf+>, TRANSient:LTIME <NRf+>, TRANSient:HTIME <NRf+>, TRANSient:RTIME <NRf+>, TRANSient:FTIME <NRf+>, TRANSient:MODE CONTInuous).

For example: assume that the CCH range is active, and the input is in OFF status, then the transient parameters should be set as follows:

Press  key to enter into transient operation;

Press  key to open transient operation menu;

Set the following parameters in transient operation menu:

LevelL: 5.000A

LevelH : 10.000A

TimeL : 0.50ms

TimeH : 0.50ms

TimeR : 0.20ms

TimeF : 0.20ms

Mode : Cont

Then press  key to turn on the input;

Or via remote command to set:

SCPI Command	Description
TRAN ON	Enables transient operation
CURR:LOW 5	Sets transient current low level to 5A
CURR:HLGH 10	Sets transient current high level to 10A
TRAN:LTIM 500us	Sets transient low level time to 500us
TRAN:HTIM 500us	Sets transient high level time to 500us
TRAN:RTIM 200us	Sets the time for transient rising edge to 200us
TRAN:FTIM 200us	Sets the time for transient falling edge to 200us
TRAN:MODE CONT	Selects continuous operation
INPUT ON	Turns on the input

Figure 2-6 shows the current waveform of the load: the load's input current reaches the transient high level (10A) after 200us duration of rising edge, and remains at 10A for 500us. Then after 200us duration of falling edge, the input current reaches the transient low level (5A), and remains at 5A for 500us. Repeat it in cycles.

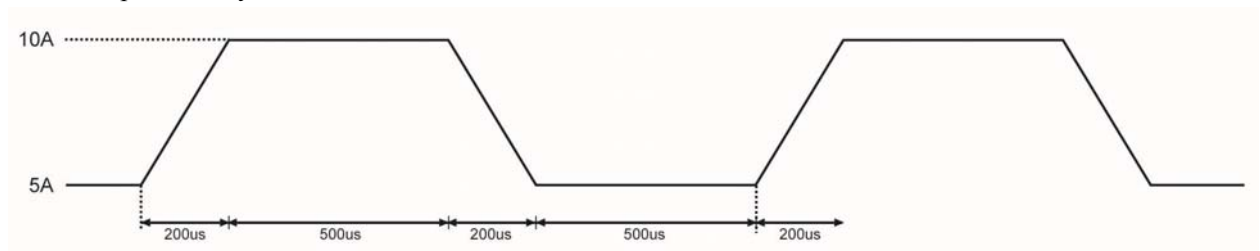



Fig. 2-6 Continuous Transient Operation

#### 2.4.2 Pulsed Transient Operation

The trigger function is required for pulsed transient operation. When there is no trigger occurs, the load remains at the transient low level. After a trigger has been received, a pulse with three stages, namely rising edge, transient high level, and falling edge, will appear, then the load returns to the transient low level again. The associated parameters such as transient low level (LevelL), transient high level (LevelH), high level time (TimeH), time for rising edge (TimeR), time for falling edge (TimeF), and pulsed transient mode can be set through transient operation menu or via remote command (CURRent:LOW <NRf+>, CURRent:HIGH <NRf+>, VOLTage:LOW <NRf+>, VOLTage:HIGH <NRf+>, RESistance:LOW <NRf+>, RESistance:HIGH <NRf+>, TRANsient:HTIME <NRf+>, TRANsient:RTIME <NRf+>, TRANsient:FTIME <NRf+>, TRANsient:MODE PULSe, TRANsient ON | OFF).

In order to get a pulse, an explicit trigger is required. The trigger can be an external trigger signal received via the TRIG input on the front panel, pressing the  key +  key, or ,the remote

command (\*TRG/TRIGger). The trigger becomes effective only when the load remains at transient low level. Each trigger leads to one pulse. In the duration of rising edge, transient high level, and falling edge, any trigger will be ignored.

For example: assume that the CCH range is active, and the input is in OFF status, then the transient parameters should be set as follows:

Press **Tran** key to enter into transient operation;

Press **Set** key to open transient operation menu;

Set the following parameters in transient operation menu:

LevelL : 5.000A

LevelH : 10.000A

TimeL : 0.50ms

TimeH : 0.50ms

TimeR : 0.10ms

TimeF : 0.10ms

Mode : Puls

Then press **Input on/off** key to turn on the input;

Send the command to the load:INIT

Or via remote command to set:

SCPI Command	Description
TRIG:SOUR EXT	Selects the external trigger input
TRAN ON	Enables transient operation
CURR:LOW 5	Sets transient current low level to 5A
CURR:HIGH 10	Sets transient current high level to 10A
TRAN:HTIM 500us	Sets transient high level time to 500us
TRAN:RTIM 100us	Sets the time for transient rising edge to 100us
TRAN:FTIM 200us	Sets the time for transient falling edge to 200us
TRAN:MODE PULS	Sets pulse trigger operating mode
INPUT ON	Turns on the input
INIT	Initialize the trigger

Get the trigger by receiving an external trigger signal. Figure 2-7 shows the current waveform of the load before it is triggered and after it has been triggered respectively: the electronic load starts its operation at the transient low level (5A) when the input is turned on. For each trigger, the load current reaches the high level (10A) after 100us duration of rising edge, and remains at 10A for 500us. Then after 200us duration of falling edge, the current returns to the transient low level (5A).

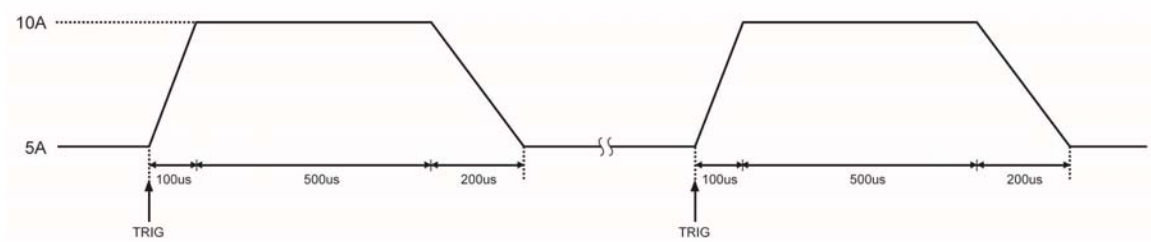

Fig. 2-7 Pulsed Transient Operation

### 2.4.3 Toggled Transient Mode

The trigger function is required for toggled transient operation. When there is no trigger occurs, the load remains at a transient level. After a trigger has been received, a toggle operation will be executed, and another transient level will be reached after the duration of rising edge or falling edge. The associated parameters such as transient low level (LevelL), transient high level (LevelH), time for rising edge (TimeR), time for falling edge (TimeF), and toggled transient mode can be set through transient operation menu or via remote command (CURRENT:LOW <NRf+>, CURRENT:HIGH <NRf+>, VOLTage:LOW <NRf+>, VOLTage:HIGH <NRf+>, RESistance:LOW <NRf+>, RESistance:HIGH <NRf+>, TRANSient:RTIME <NRf+>, TRANSient:FTIME <NRf+>, TRANSient:MODE TOGGLE, TRANSient ON | OFF).

The trigger can be an external trigger signal received via the TRIG input on the front panel, pressing the **2nd** key + **Trigger** key, or the remote command (\*TRG/TRIGger).

For example: assume that the CCH range is active, and the input is in OFF status, then the transient parameters should be set as follows:

Press **Tran** key to enter into transient operation;

Press **Set** key to open transient operation menu;

Set the following parameters in transient operation menu:

LevelL: 5.000A

LevelH : 10.000A

TimeL : 0.50ms

TimeH : 0.50ms

TimeR : 0.10ms

TimeF : 0.20ms

Mode : Togg

Then press **Input on/off** key to turn on the input;

Send the command to the load:INIT

Or via remote command to set:

SCPI Command	Description
TRIG:SOUR EXT	Selects the external trigger input
TRAN ON	Enables transient operation

CURR:LOW 5	Sets transient current low level to 5A
CURR:HIGH 10	Sets transient current high level to 10A
TRAN:RTIM 100us	Sets the time for transient rising edge to 100us
TRAN:FTIM 200us	Sets the time for transient falling edge to 200us
TRAN:MODE TOGG	Selects toggled operating mode
INPUT ON	Turns on the input
INIT	Initialize the trigger

Get the trigger by receiving an external trigger signal. Figure 2-8 shows the current waveform of the load before it is triggered and after it has been triggered respectively: the electronic load starts its operation at the transient low level (5A) when the input is turned on. For the first trigger, the load current reaches and remains at the high level (10A) after 100us duration of rising edge. When the second trigger is received, the load current will reach and remain at the low level (5A) after 200us duration of falling edge. Each trigger leads to one toggle operation.

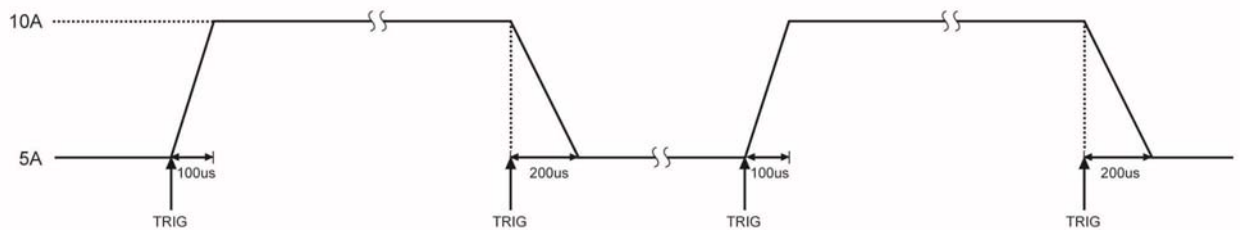

Fig. 2-8 Toggled Transient Operation

## 2.5 List Operation

Besides Transient operation, the electronic load provides more flexible list operation, which can make the load operate according to the preset sequence.

The list operation allows you to program a series of sequence steps, and the operation mode, the load values, the duration time for each step can be set. The sequence operation can be executed in the CC, CV, and CR modes. The minimum duration for each step is 10us, and the maximum one is 99999.99999s (around 27.78 hours). The list operation allows to be executed cyclically, and the cycle times can be set; the different list can be chained so that when one list has been executed, the another chained list will be enabled, which further perfects the capability of the list test to implement more complicated test task. Each list can contain 50 steps at most, and the load can store 7 lists.

The associated parameters of list operation can be edited and set through list operation menu or via remote command. The load provides convenient list editing function. When the user is operating input/edit sequence step, it is easy to check the previous and subsequent steps, and it is allowed to be edited, inserted, and deleted immediately, which simplifies the list input operation effectively.

The set value of each step will be automatically saved when exiting from step edit menu, and the other list parameters will be saved immediately after been edited.

The list operation also can be implemented via the remote command.

Please make sure the transient operation has been disabled before enabling list operation. In list operation, if the operation mode for next step is different from the present step, the load will automatically have a 5ms-delay after the present step is over to avoid the probable current surge. The load's input will be turned off during this 5ms-delay.



Figure 2-9 is a list running diagram for 5 steps. See Chapter 4 for detailed information about programming lists from the front panel.

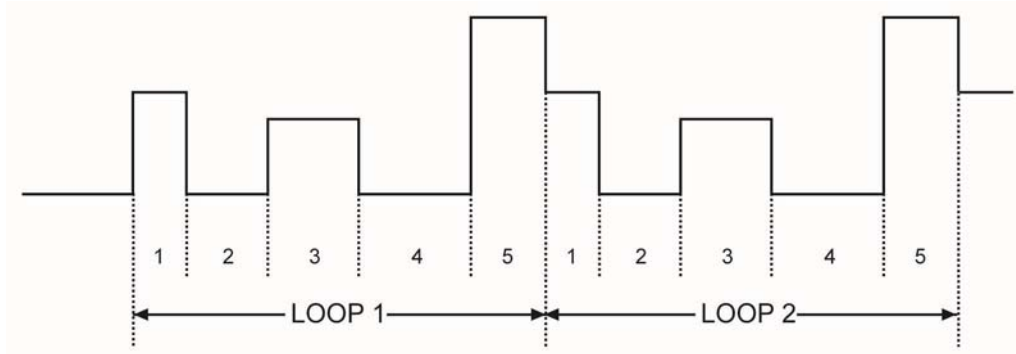

Fig. 2-9 List Operation

Note: In list operation, the Von point and current limit level should be taken into consideration, which may cause the shut down of the input, thus interrupt the list operation.

## 2.6 Battery Discharge Operation

The electronic load adopts constant current discharge to test battery capacity. The discharge current and cut-off voltage can be self-defined. When the battery voltage decreases to the cut-off voltage, the battery discharge test will stop automatically. The test procedure is shown as figure 2-10. The load can real-time display battery voltage, discharge current, discharge time, and discharge capacity during the test. The maximum battery discharge time is 99hours 99minutes 99 seconds, and the maximum battery capacity for different models is listed as follows:

Model	3720A	3721A	3722A	3723A	3724A
Capacity	3000Ah	4000Ah	2000Ah	3000Ah	2000Ah

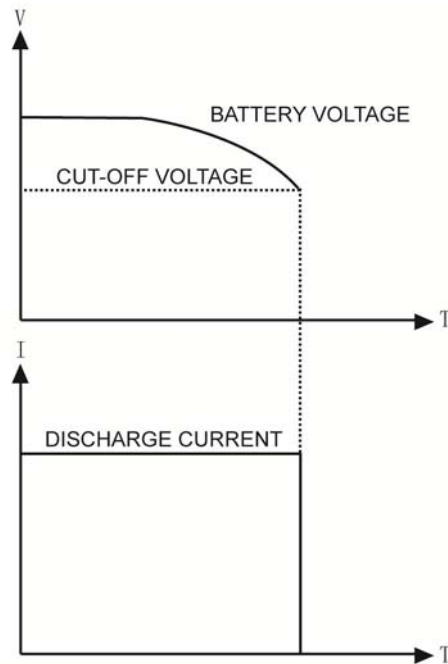

Fig. 2-10 Voltage/Current Curve Chart in Battery Discharge Operation

## 2.7 Short Circuit Operation

The electronic load can simulate a short circuit to test the protection performance of the tested device. The short circuit operation can be enabled and disabled by setting in the main menu, or via the remote command (INPut:SHORT ON/OFF). The other set values will not be changed when the short circuit operation is enabled. The short-circuit value depends on the present operating mode of the load, and the short-circuit value for each model is shown as follows:

	Model	3720A	3721A	3722A	3723A	3724A
Mode	CCL	3.3A	4.4A	2.2A	3.3A	2.2A
	CCH	33A	44A	22A	33A	22A
	CV	0V	0V	0V	0V	0V
	CRL	0.018 Ω	0.018 Ω	0.06 Ω	0.06 Ω	0.12 Ω
	CRM	1.8 Ω	1.8 Ω	6 Ω	6 Ω	12 Ω
	CRH	18 Ω	18 Ω	60 Ω	60 Ω	120 Ω
	CPV	270W	420W	220W	370W	270W
	CPC	0W	0W	0W	0W	0W

Note: in short circuit operation, the Von point and current limit level should be taken into consideration, which may cause the shut down of the input, thus interrupt the short circuit operation.

## 2.8 Triggered Operation

The triggered operation is mainly used to make the load keep synchronized with other test equipments or events. Array 372x Series electronic load provides various triggering modes, which can be applied to the following occasions:

- **Triggering a preset level**

Transfer all pending preset levels to the immediate levels. For the presently active mode, the new level will appear at the input at once if the input is turned on. For the modes which are not presently active, the preset levels will not take effect at the input until the corresponding mode becomes active.

- **Triggering a transient pulse**



Generate a transient pulse in accordance with the preset transient parameters, when pulsed transient operation is active.

- **Triggering a transient toggle**



Switch the input between the transient low level and transient high level in accordance with the preset transient parameters, when the toggled transient operation is active.

- **Triggering a list test**

Enable the present list test when the list operation is active.

Three triggering methods are available for remote control: GPIB <GET> signal, the \*TRG and TRIGger commands. The External trigger input terminal and  key +  key on the front panel of the load can be used to trigger as well.



The load has three triggering modes: BUS, EXTERNAL, and HOLD.

- **The BUS mode:** the trigger source is GPIB <GET> signal, or \*TRG command.
- **The EXTERNAL mode:** Choose the External trigger input terminal or  key +  key on the front panel as the trigger source. The input signal at the External trigger input terminal is TTL, the falling edge (signal) is triggered..
- **The HOLD mode:** Use TRIGger:IMMEDIATE command as the trigger source. At this time, all other triggering methods including \*TRG become invalid.

Note: The TRIGger:IMMEDIATE command can be used in all three triggering modes. The triggering modes can be selected via the remote command only (TRIGger:SOURce BUS; TRIGger:SOURce EXTERNAL; TRIGger:SOURce HOLD).

## 2.9 Input Control

### 2.9.1 Turning On/Off the Load

The input can be turned on/off by pressing  key, or via the remote command (INPUT ON/OFF). If the load's input stays in OFF status, press  key to turn on the input; if the load's input stays in ON status, press  key to turn off the input. Turning the input on/off (zero current) does not affect the programmed settings.

In local control, if the input is turned on, the load status can not be switched directly among the basic modes, transient operation, list operation, battery discharge operation, etc. The load can be switched from one operation status to another operation status only when the input is turned off.

### 2.9.2 Von Point/Von Latch

When the external input voltage is less than the Von Point, the load will not be enabled even though the input has been turned on. The load will be enabled till the external input voltage reaches or exceeds the Von Point.

Von Latch is used to latch the active status of the load. If the Von Latch function is enabled, once the input voltage reaches Von Point, the input will be turned on, and stay in ON status regardless of the changes from the external input voltage, even though the input voltage is less than the Von point. Please see figure 2-11; if the Von Latch function is disabled, once the input voltage reaches Von Point, the input will be turned on automatically, and once the input voltage is less than the Von Point, the input will be automatically turned off. Please see figure 2-12. The automatical turning on /off of the input can be implemented via setting the Von Point and Von Latch, which simplifies test operation greatly.

The Von Voltage can be set in main menu, or via the remote command (INPut:LATCh:VOLTage <NRf+>).

The Von Latch can be set in main menu, or via the remote command (INPut:LATCh ON | OFF).

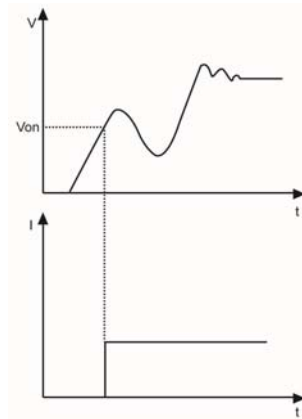

Fig. 2-11 Von Latch Is Enabled

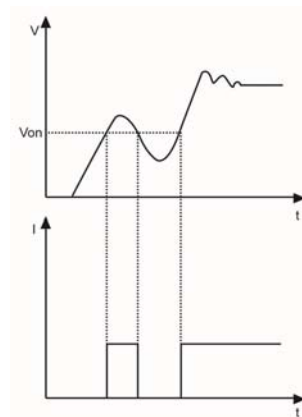

Fig. 2-12 Von Latch Is Disabled

Note: If the load is unable to operate normally, please check the setting of Von Point.

### 2.9.3 Current Limit in CV Mode

The CV Curr Limit is used to limit the maximum input current in CV mode. If the voltage is still larger than the set level while the current limit has been reached, the load will switch to the CC mode. Please see figure 2-13. The input will not be turned off in the CV current limit, which is different from the software current limit.

The CV Curr Limit can be set in main menu, or via the remote command ( INPut:LIMit:CURRENT <NRf+>).

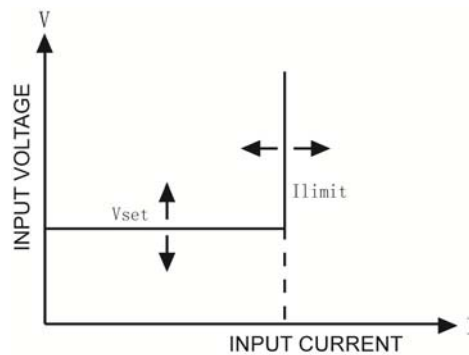

Fig.2-13 CV Curr Limit

### 2.9.4 Current Rise Rate

The Current Rise Rate is used to set the current rise rate in CC mode. It can be set in main menu, or via the remote command (CURRent:RISE:RATE <NRf+>).

If the current rise rate is 0.1A/us, and the current set level is 20A, then the current rise rate is shown as below when the input is turned on:

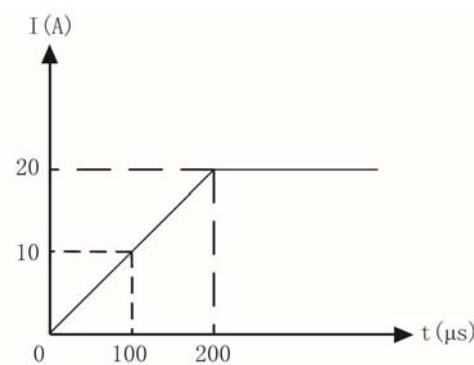

Fig.2-14 Current Rise Rate

Note: The Current Rise Rate can be effective only in CCH and CCL, and the actual rise rate is one tenth of the set level in CCL.

### 2.9.5 Current Fall Rate

The Current Fall Rate is used to set the current fall rate in CC mode. It can be set in main menu, or via the remote command (CURRent:FALL:RATE <NRf+>).

If the current fall rate is 0.1A/us, and the current set level is 20A, then the current rise rate is shown as below when the input is turned off:

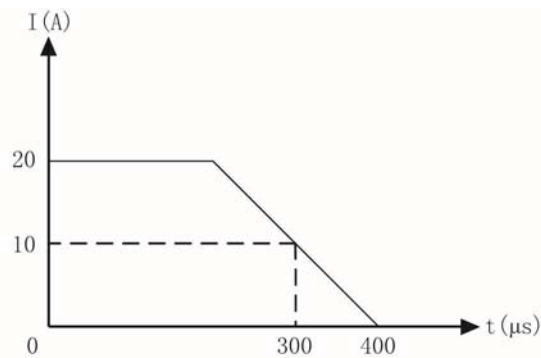

Fig.2-15 Current Fall Rate

Note: The Curr Fall Rate can be effective only in CCH and CCL mode, and the actual rise rate is one tenth of the set level in CCL.

### 2.10 Measurement Function

The electronic load has measurement system with high resolution. The input current level and voltage level can be measured in real time. The input power level and resistance level can be computed with the input voltage level and current level. Each measured value can be checked through LCD display or via the remote command (MEASure:VOLTage?, MEASure:CURREnt?, MEASure:RESistance?, MEASure:POWer?).

### 2.11 Saving and Recalling





The electronic load is provided with an EEPROM memory, which can save various parameters, such as modes, input status, current, voltage, resistance, transient settings, limits, etc. 372x Series electronic load can save 10 groups of parameters. All parameters relevant to saving and recalling operation are listed in List 2-1 (Take 3721A as an example.).

List 2-1

Function	Effect	Default
Input	Input status	Off
Mode	Operation mode	CCH
Current level	Immediate current level	0A
Current rise rate	Current rise rate	4A/us
Current fall rate	Current fall rate	4A/us
Current Hlevel	Transient current high level	0A
Current Llevel	Transient current low level	0A
*Current protection level	Current limit	40A
*Current protection delay	Current protection delay	60s
*Current protection State	Enable/disable current protection	off
Voltage level	Immediate voltage level	80v

CV current limit	Current limit in CV mode	40A
Voltage Hlevel	Transient high voltage level	80v
Voltage Llevel	Transient voltage low level	80v
Resistance level	Immediate resistance level	2000 $\Omega$
Resistance Hlevel	Transient high resistance high level	2000 $\Omega$
Resistance Llevel	Transient resistance low level	2000 $\Omega$
Power level	Immediate power level	0W
Transient operation	Transient test	off
Transient mode	Transient mode	continuous
Transient Htime	Time for transient high level	0ms
Transient Ltime	Time for transient low level	0ms
Transient Rtime	Time for transient rising edge	0.01ms
Transient Ftime	Time for transient falling edge	0.01ms
Trigger Function	Trigger function selection	Tran
*Trigger source	Trigger source	external
Battery Mode	Battery discharge operation	off
Battery mini voltage	Battery minimum termination voltage	0V
Battery discharge current	Battery discharge current	0A
Voltage on	Von point for the load	0V
Voltage on Latch	Latch the Von point	Off

\* indicates it only can be programmed in the remote control.



The 10 groups of parameters stored in Location 0~9 can be saved and recalled by pressing  key +  key and  key +  key, or via the remote command (\*SAV < NRI > and \*RCL < NRI >).

The parameter saved in Location 0 will be recalled automatically every time the load is turned on.

## 2.12 Reading Remote Programming Errors

The Err annunciator will be turned on when remote programming errors occur. The error codes are shown as followings:

- -1xx Command errors
- -2xx Execution errors
- -3xx Device-specific errors
- -4xx Query errors

Remote programming errors can be checked by pressing  key after pressing  key on the front panel. The remote command (SYSTem:ERRor?) can reads back the error codes and error messages when it is in remote control.

All errors are saved in one error queue. The errors in this error queue are read in the order in which they occurred. At most 20 error messages can be saved in the error queue. If the errors exceed 20, the last error in the error queue will be replaced with -350, "Too many errors". The load will not save any additional error message, unless you clear or read errors from the queue. Once the error message is read, it will be cleared in the error queue.

### 2.13 Status Report

The electronic load incorporates a status reporting register. Various status conditions of the load can be reported by querying the status register. The user can make sure which event has been reported through setting the enable register, which will be introduced in details in "ARRAY 372x Series Electronic Load SCPI Programming Guide".



### 2.14 Protection Function



The electronic load is equipped with the following protection functions:

- Overvoltage (OV)
- Overcurrent (OC)
- Overpower (OP)
- Overtemperature (OT)
- Reverse Voltage (RV)

Once any of the above protection function is active, the corresponding status bit in the status will be set; the input will be turned off with beeps; the detected conditions will be displayed; the load will enter into the latched protection status, and will not respond to other commands except some specific operations. For example: if an overtemperature conditions has been detected, the input will be turned off with beeps, and OT will be shown in the lower right corner of the display. The load will have no response to other operations.

#### 2.14.1 Clearing Latched Protection

When the load enters into the latched protection status, it will have no response to other commands. The load will return to the normal operation only when the latched protection has been reset via pressing  key +  key or the remote command (INPut:PROTection:CLEar). Of course, the condition that cause the latched protection must be removed, or it will be latched again as soon as it is reset.

In addition, when the software overcurrent protection is enabled, if the overcurrent time does not exceed the specified protection time, the load will display PT to indicate, but the input will not be turned off. At this time, you can reset the overcurrent time with  key +  key or the remote command (INPut:PROTection:CLEar).



### 2.14.2 Overvoltage

The overvoltage protection level is set at a predetermined voltage, which cannot be changed by the user. When the input voltage exceeds this predetermined voltage, the overvoltage protection will be enabled, and the input is turned off with OV displayed, meanwhile, the OV and VF status register bits are set, and will remain set until they are reset and overvoltage condition is removed.

### 2.14.3 Overcurrent

The electronic load allows the user to define a current protection limit. When the defined current limit is exceeded, the overcurrent timer starts timing, and the display will show PT to indicate protection status, but the input will not be turned off immediately. When the specified delay time is reached, the overcurrent protection will be enabled and the input is turned off with OC displayed, meanwhile, the OC and PS status register bits are set, and will remain set until they are reset and overcurrent condition is removed. The current protection limit function can only be set via the remote command.

SCIP Command	Description
CURRent:PROTection:STATe ON/OFF	Turns on/off the current protection limit function
CURRent:PROTection<NRf+>	Sets the current limit level
CURRent:PROTection:DELay < NRf+>	Sets the delay time to turn off the input

### 2.14.4 Overpower

The electronic load includes both hardware and software overpower protection functions.

Once the input power exceeds the maximum rated power, the hardware power-limit circuit will be enabled immediately to limit the input power within the allowed range, in the meantime, the load will compute the present actual power.

No matter the hardware power-limit circuit is enabled, or use software to compute, the overpower protection will become active as long as the overpower time exceeds the specified limit. When the overpower protection is enabled, the input will be turned off with OP displayed, meanwhile, the OP and PS status register bits are set, and will remain set until they are reset and overpower condition is removed.

### 2.14.5 Overtemperature

If the internal temperature of the load exceeds safe limits, the overtemperature protection will be enabled; the input will be turned off with OT displayed, in the meantime, the OT and PS status register bits are set, and will remain set until they are reset and overtemperature condition is removed. You must wait until the load cools down to the normal temperature before you can reset the latched protection. The fans in the load will help to cool the load as quickly as possible.

### 2.14.6 Reverse Voltage

When reverse voltage is applied, the reverse voltage protection will be enabled; the input will be turned off with RV displayed, in the meantime, the RV and VF status register bits are set, and will remain set until they are reset and reverse voltage is removed.

## 2.15 Auxiliary Functions

### 2.15.1 Trigger Function Selection

The Trigger Function in main menu is used to select the trigger object. Selecting “Tran” is used to

trigger transient operation, and selecting List is used to trigger sequence (list) operation.

### 2.15.2 Knob Function

The Knob in main menu is used to enable/disable the knob function. Select On to enable the knob function, and select Off to disable.

### 2.15.3 Key Sound

The Key Sound in main menu is used to control the key sound. Select On to activate the key sound and select Off to forbid.

## Chapter3 Installation

### 3.1 Initial Check

When you receive the load, please check it for any obvious damage that may have occurred during shipment. Keep the original packing materials in case the load has to be returned to ARRAY in the future.

Please confirm that there are no broken keys or knobs, that the cabinet and panel surfaces are free of dents or scratches, and that the display is not scratched or cracked.

### 3.2 Environment/Installation Location

The load can operate at its full power within the temperature range of 0 °C to 40 °C, and at derated power from 40 °C to 50 °C, or the overtemperature protection will be caused.

Place the load in a location with good ventilation, and keep a distance from electromagnetic interference. Do not place the load in the flammable atmosphere.

Your load must be installed in a location that allows sufficient space at the sides and rear of the load for adequate air circulation. The fans cool the load by drawing in air through the sides and exhausting it out from the back. The rubber bumpers must be removed for rack mounting.

### 3.3 Power-On/ Self-Test

A power-on self-test can inspect the basic operations of the load to assure you that the load is operational.

First, before the load is switched on, check AC power-line voltage to verify the power-line voltage selected by 110V/220V Toggle Key on the rear panel is in accordance with the proper voltage in your local place.

Connect the power-line cord and a power-on self-test occurs automatically when you turn on the load. If the load detects an error during power-on self-test, the error messages will be displayed as shown below:

Error Codes	Error Messages
601	LCD self-test error

603	System ADC test failed
607	Rundown too noisy
608	Keypad self-test error
609	EEPROM checksum failed
630	Temperature test failed

If there is no error is detected, the LCD will show CCH, the initial display, and the input will be turned off. If the parameters was modified previously and saved in location 0, the load will recall these modified parameters automatically. After around 20 minutes' warm-up of the load, the following test can be executed:

Connect the output of a power supply to the load's input with correct polarity to execute CCH 5A and CV 5V operations. If the load works normally, it will draw 5A or set input voltage to 5V within the allowed tolerance.

### 3.4 Connections on the Rear Panel

The rear panel of 372x Series electronic load is shown as fig. 3-1, which mainly includes AC input part and communication interface part. The AC input part includes AC input socket, Fuse holder, and Line voltage switch; the interface part includes RS-232 interface and the interface for optional GPIB or USB.

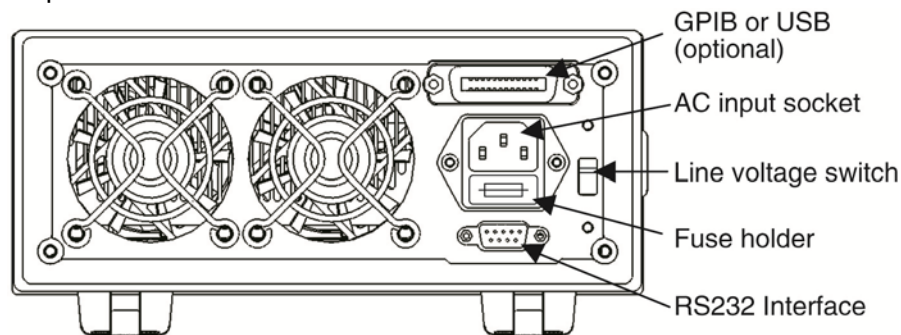

Fig. 3-1

#### AC input:

AC power-line cord must be appropriate for your local standard.

The specifications of the fuse: 250V 315mA.

Line voltage switch can select 110V or 220V. The selected voltage should be in accordance with the proper voltage in your local place.

#### Communication Interfaces:

##### RS-232 Interface:

The load provides a RS-232 interface, which is a standard DB9 pin connector using DTR and DSR to execute flow control. The pin assignment is shown below:

Pin	Input/Output	Description
1	-	Not used
2	Input	RXD Receive data
3	Output	TXD Transmit data
4	Output	DTR Data terminal ready
5	Common	GND Ground
6	Input	DSR Data set ready

7	-	Not used
8	-	Not used
9	-	Not used

The interface parameters can be set in the MENU, and you can use SCPI language for programming to realize the communication with the load.

#### GPIB Interface:

The load provides a GPIB interface, and you can set its address to any value between 0 and 30 in MENU. When multiple GPIB devices are connected, each device on the GPIB interface must have a unique address that is not be used by the devices on other interfaces. The address is set to “05” when the load is shipped from the factory.

#### USB Interface:

The load provides a USB interface. You need to install the software provided by the factory in PC to realize communication with the load.

USB and GPIB interfaces occupy the same expansion slot on the rear panel, so only one type interface can be chosen to install at the same time, meanwhile, only one type interface can be used by the load to communicate with external devices.

### 3.5 Connections on the Front Panel

The terminals of 372x Series electronic load on the front panel include input terminals (INPUT+, INPUT-), remote sense terminals (SENSE +, SENSE -), and an external trigger input terminal. See Fig. 3-2.

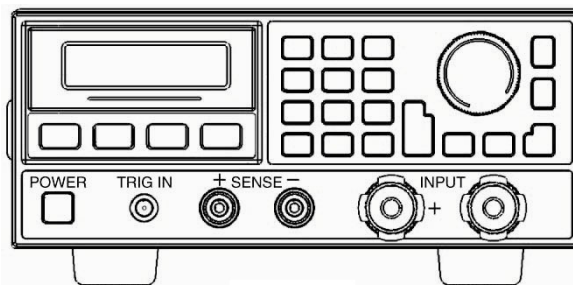

Fig.3-2

#### Input Connections

Input connections are made to two binding posts (INPUT+, INPUT-) on the front panel. The maximum wire diameter is 6mm. In order to enhance the test accuracy, and reduce the test error when executing large current test, it would be better to use thicker wire.

#### Remote Sense Terminals

Remote sensing is made to two terminals (SENSE+, and SENSE-). It compensates for the voltage drop caused by the power supply and input wire resistance to achieve greater accuracy.

372x Series electronic load can detect remote voltage inputs automatically, so there is no need to modify the parameter settings or change the hardware wiring when using remote sensing.

#### External Trigger Input Terminal

The external trigger input terminal on the front panel is a BNC connector, in which the middle part is the input+, and the outer casing is the input-. It receives 5V TTL-compatible falling-edge trigger signals. In order to get a reliable trigger, the duration time of low level should be longer than 10 $\mu$ s.

### 3.6 Wiring

#### Sense Connections

As the influence of connected power and the conductor resistance of the load, the voltage at the input terminals will be lower than output voltage when the current flows across the load,

When greater accuracy of voltage test is needed, it is necessary to connect Sense input, and the load will switch to Sense status automatically. The relevant wiring is shown as fig.3-3.

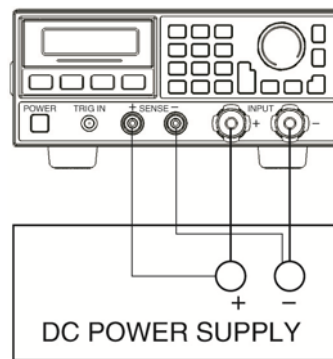

Fig.3-3

#### Parallel Connections

Figure 3-4 illustrates how two or more loads can be paralleled in CC mode when high power or large current is needed.

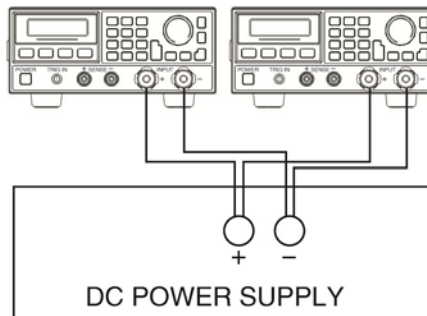



Fig. 3-4



## Chapter 4 Local Operation

The local operation of the load has been briefly introduced in Chapter 2. In this chapter, it will be explained in details with examples.

### 4.1 Local Control

If it is needed to control the load from the front panel, the load must stay in the local control status. The load enters into local control status once it is powered on, and preset parameters saved in EEPROM location 0 will be recalled automatically.

Under remote control status, all operations on front panel keypad and knobs become invalid (except  key +  key). When the load receives a remote command (SYST:REM) via RS232 or GPIB, the remote control goes into effect and REM annunciator is turned on.

Under remote control status, all operations on electronic load are controlled by remote controller. The electronic load will return to local control after receiving the return command (SYST:LOCAL). Or you can return the electronic load to local control by pressing  key +  key.



### 4.2 Main Operation on the Front Panel

- Connecting to the Power Supply
- Turning the Input On/Off
- CC Mode
- CV Mode
- CR Mode
- CP Mode
- Short Circuit Operation
- Continuous Transient Operation
- Pulsed Transient Operation
- Toggled Transient Operation
- List Operation
- Battery Discharge Operation
- Saving and Recalling Parameters
- Clear Protection Settings
- Error Messages
- Triggered Operation
- Main Menu

### 4.3 Connecting to the Power Supply

Connect the positive pole of the power supply to the INPUT + terminal, and connect the negative pole of the power supply to the INPUT - terminal. If the input is connected reversely, the RV

protection status of the load will become effective. In this case, disconnect the power supply from the load and then make the correct connections.









After the power supply is correctly connected to the load, press  key +  key to clear the RV protection status or restart the load. The relevant details will be described in “Clearing Protection Settings”.

#### 4.4 Turning the Input On/Off

Press  key to turn on or turn off the input.

#### 4.5 Basic Operation







The operating procedures for basic tests are shown below:



1. Press  key to enter into mode selection and parameter setting menu.
2. Use ,  keys to select one operating mode.
3. Use Entry keys, or use the knob together with ,  keys to input set value.  key may be used to clear the values entered at present, or exit mode selection and parameter setting menu..
4. Press  key to confirm and exit mode selection and parameter setting menu
5. Press  key to turn on the load’s input..

##### 4.5.1 CC Mode

Constant current mode has two ranges, the high range (CCH) and the low range (CCL).

Example 1: Take 3721A as an example, in CV mode, set the load to CCH, the current to 5.12A,,and turn on the load. The operating procedures are shown below:

Procedures	Operation Descriptions	Display
1	Press  key to enter into the mode selection and parameter setting menu (e.g: the load is in CV mode).	MODE : CV CURR : 80.000A
2	Use  or  key to select CCH.	MODE : CCH CURR : 0.000A
3	Use Entry keys, or use the knob together with  ,  keys to input the current value to 5.12.	MODE : CCH CURR : 5.120A
4	Press  key to confirm and exit mode selection and parameter setting menu.	5.000V 0.000A 5.120A CCH OFF
5	Press  key to turn on the load.	5.000V 5.120A 5.120A CCH ON





6	Use  ,  key to check the current power value.	0.000V    0.000A 5.1 <u>20</u> A    0.000W
---	---	---

For the above operating procedures, the corresponding SCPI commands should be:



MODE        CCH                                ; Sets the mode  
 CURR        5.1                                    ; Sets the current value  
 INP         ON                                    ; Turns on the load

Example 2: Current setting is 5.8A in CCH, input is on.

Solution 1:

Procedures	Operation Descriptions	Display
1	Press  key to enter into the mode selection and parameter setting menu.	MODE : CCH CURR : 5.1 <u>20</u> A
2	Use Entry keys, or use the knob together with  ,  keys to input the current value to 5.8.	MODE : CCH CURR : 5.8 <u>00</u> A
3	Press  key to confirm and exit the mode selection and parameter setting menu.	5.000V    5.800A 5.8 <u>00</u> A    CCH ON
4	Press  key to turn on the load.	0.000V    0.000A 5.8 <u>00</u> A    CCH ON

Solution 2:

Procedures	Operation Descriptions	Display
1	Move the cursor to the hundredths with  key.	0.000V    0.000A 5.1 <u>20</u> A    CCH OFF
2	Rotate the knob to set the hundredths to 0. (Rotating the knob will change the set value immediately. And when the load is powered on, the new set value will become valid at the input terminal at once.)	0.000V    0.000A 5.1 <u>00</u> A    CCH OFF
3	Move the cursor to the tenths with  key.	5.000V    5.100A 5. <u>1</u> 00A    CCH ON
4	Rotate the knob to set the tenths to 8. (Rotating the knob will change the set value immediately. And when the load is powered on, the new sett value will become valid in the input terminal at once.)	5.000V    5.800A 5. <u>8</u> 00A    CCH ON
5	Press  key to turn on the load.	0.000V    0.000A 5. <u>8</u> 00A    CCH ON

For the above operating procedures, the corresponding SCPI commands should be:











MODE CCH ; Sets the mode  
 CURR 5.8 ; Sets the current value  
 INP ON ; Turns on the load

Note: In CCH status or CCL status, CCH /CCL will be shown respectively in the lower right corner of the display.

#### 4.5.2 CV Mode

Example 1: Take 3721A as an example, set the load to CV mode and the voltage value to 50V in CCH. Then turn on the load, and check the present power value. The operating procedures are shown below:

Procedures	Operation Descriptions	Display
1	Press  key to enter into the mode selection and parameter setting menu.	MODE: CCH CURR: 3.80 <u>0</u> A
2	Use  key to select CV mode.	MODE: CV VOLT: 80.00 <u>0</u> V
3	Use Entry keys or use the knob together with  ,  keys to input the voltage value to 50.	MODE: CV VOLT: 50.00 <u>0</u> V
4	Press  key to confirm and exit the mode selection and parameter setting menu.	0.000V 0.000A 50.00 <u>0</u> V CV OFF
5	Press  key to turn on the load.	0.000V 0.000A 50.00 <u>0</u> V CV ON
6	Check the present power value with  ,  keys.	0.000V 0.000A 50.00 <u>0</u> V 0.000W



For the above operating procedures, the corresponding SCPI commands should be:

MODE CV ; Sets the mode  
 VOLT 50 ; Sets the voltage value  
 INP ON ; Turns on the load

Example 2: Set the voltage value to 60V in CV mode.

Turn on the load, and there are two ways to set the voltage value.

Solution 1:

Procedures	Operation Descriptions	Display
1	Press  key to enter into the mode selection and parameter setting menu.	MODE: CV CURR: 50.00 <u>0</u> V
2	Use Entry keys or use the knob together with  ,	MODE: CV VOLT: 60.00 <u>0</u> V

	keys to input the voltage value to 60.	
3	Press  key to confirm and exit the mode selection and parameter setting menu.	0.000V 0.000A 60.00 <u>0</u> V CV OFF
4	Press  key to turn on the load.	0.000V 0.000A 60.00 <u>0</u> V CV ON

Solution 2:

Procedures	Operation Descriptions	Display
1	Move the cursor to the tens with  key.	0.000V 0.000A <u>5</u> 0.000V CV ON
2	Rotate the knob to set the tens to 6. (Rotating the knob will change the set value immediately.. The set value will become effective at input at once when the load is turned on.)	0.000V 0.000A <u>6</u> 0.000V CV OFF
3	Press  key to turn on the load.	0.000V 0.000A <u>6</u> 0.000V CV ON

For the above operating procedures, the corresponding SCPI commands should be:

MODE CV ; Sets the mode  
VOLT 60 ; Sets the voltage value  
INP ON ; Turns on the load



Note: CV will be shown in the lower right corner of the display when the load is in CV mode.

### 4.5.3 CR Mode

CR Mode includes constant resistance low range (CRL), constant resistance medium range (CRM), and constant resistance high range (CRH).

Example 1: Take 3721A as an example, set the load to CRL and set the resistance value to 1.5 Ω in CV mode. Turn on the load, and check the present power value. The operating procedures are shown below:

Procedures	Operation Descriptions	Display
1	Press  key to enter into the mode selection and parameter setting menu.	MODE: CV CURR: 50.00 <u>0</u> V
2	Use  key to select CRL.	MODE: CRL RES : 0.020 <u>0</u> Ω
3	Use Entry keys or use the knob together with , keys to input the resistance value to 1.5.	MODE: CRL RES : 1.500 <u>0</u> Ω
4	Press  key to confirm and exit the mode	0.000V 0.000A 1.500 <u>0</u> Ω CRL OFF

	selection and parameter setting menu.		
5	Press  key to turn on the load.	0.000V 1.5000Ω	0.000A CRL ON
6	Check the present power value with  ,  .	0.000V 1.5000Ω	0.000A 0.000W





For the above operating procedures, the corresponding SCPI commands should be:

MODE CRL ; Sets the mode  
RES 1.5 ; Sets the resistance value  
INP ON ; Turns on the load



Example 2: Set the resistance value to 1.8 Ω in CRL.

Turn on the load, and there are two ways to set the resistance value.

Solution 1:

Procedures	Operation Descriptions	Display	
1	Press  key to enter into the mode selection and parameter setting menu.	MODE: CRL RES : 1.5000Ω	
2	Use Entry keys or use the knob together with  ,  keys to input the resistance value to 1.8.	MODE: CRL RES : 1.8000Ω	
3	Press  key to confirm and exit the mode selection and parameter setting menu.	0.000V 1.8000Ω	0.000A CRL OFF
4	Press  key to turn on the load.	0.000V 1.8000Ω	0.000A CRL ON

Solution 2:

Procedures	Operation Descriptions	Display	
1	Move the cursor to the tenths with  key.	0.000V 1.5000Ω	0.000A CRL OFF
2	Rotate the knob to set the tenths to 8. (Rotating the knob will change the set value immediately. The set value will become effective at input at once when the load is turned on.)	0.000V 1.8000Ω	0.000A CRL OFF
3	Press  key to turn on the load.	0.000V 1.8000Ω	0.000A CRL ON

For the above operating procedures, the corresponding SCPI commands should be:

MODE CRL ; Sets the mode  
RES 1.8 ; Sets the resistance value  
INP ON ; Turns on the load









Note: CRH /CRM/CRL will be shown respectively in the lower right corner of the display when

the load is in CRH status, CRM status or CCL status.

#### 4.5.4 CP Mode

CP Mode includes constant power-current source mode (CPV) and constant power-voltage source mode (CPC).

Example 1: Take 3721A as an example, set the load to CPV and set the power value to 100W in CRL. Turn on the load, and check the present power value. The operating procedures are shown below:

Procedures	Operation Descriptions	Display
1	Press  key to enter into the mode selection and parameter setting menu.	MODE: CRL RES: 1.800Ω
2	Use  key to select CPV.	MODE: CPV POWR: 0.00W
3	Use Entry keys or use the knob together with  ,  keys to input the power value to 100.	MODE: CPV POWR: 100.0W
4	Press  key to confirm and exit the mode selection and parameter setting menu.	0.000V 0.000A 100.0W CPV OFF
5	Press  key to turn on the load.	0.000V 0.000A 100.0W CPV ON
6	Check the present power value with  ,  .	0.000V 0.000A 100.0W 0.000W





For the above operating procedures, the corresponding SCPI commands should be:

MODE CPV ; Sets the mode  
POW 100 ; Sets the power value  
INP ON ; Turns on the load

Example 2: Set the power value to 200W in CPV mode.



Turn on the load, and there are two ways to set the power value.

Solution 1:

Procedures	Operation Descriptions	Display
1	Press  key to enter into the mode selection and parameter setting menu.	MODE: CPV POWR: 100.0W
2	Use Entry keys or use the knob together with  ,  keys to input the power value to 200.	MODE: CPV POWR: 200.0W
3	Press  key to confirm and exit the mode selection and parameter setting menu.	0.000V 0.000A 200.0W CPV OFF

4	Press  key to turn on the load.	0.000V      0.000A 200.00W    CPV ON
---	--	---

Solution 2:

Procedures	Operation Descriptions	Display
1	Move the cursor to the hundredths with  key.	0.000V      0.000A <u>1</u> 00.00W    CPV OFF
2	Rotate the knob to set the hundredths to 2. (Rotating the knob will change the set value immediately. The set value will become effective at input at once when the load is turned on.)	0.000V      0.000A <u>2</u> 00.00W    CPV OFF
3	Press  key to turn on the load.	0.000V      0.000A <u>2</u> 00.00W    CPV ON











For the above operating procedures, the corresponding SCPI commands should be:

MODE      CPV                    ; Sets the mode  
POW      200                        ; Sets the power value  
INP      ON                         ; Turns on the load

Note: CPV /CPC will be shown respectively in the lower right corner of the display when the load is in CPV or CPC mode.









#### 4.6 Short Circuit Operation

The operating procedures for short circuit operation are shown below:

1. Press  key to enter into main menu, and select Short (short circuit) item with  key.
2. Use  key or knob to set On, and press  key to confirm.
3. Press  key to exit the main menu. The display shows “s” to indicate in the basic test mode.
4. Press  key to enter into the mode selection and parameter setting menu; use ,  keys to select one basic operating mode; press  key to confirm and exit the mode selection and parameter setting menu.
5. Press  key to turn on the load.

Example 1: The load was in CV mode previously and it is turned off. Set the load to short circuit in CCH status. Turn on the load to execute short circuit operation.

Procedures	Operation Descriptions	Display
1	Press  key to enter into main menu, and select Short	Short: On *Off

	(short circuit) item with  key.	
2	Use  key or knob to set On, and press  key to confirm.	Short: *On Off
3	Press  key to exit the main menu. The display shows “s” to indicate in CV mode.	0.000V 0.000A 0.000V sCV OFF
4	Press  key to enter into the mode selection and parameter setting menu; use  key to select CCH; press  key to confirm and exit the mode selection and parameter setting menu.	0.000V 0.000A 44.000A sCCH OFF
5	Press  key to turn on the load.	0.000V 0.000A 44.000A sCCH ON







For the above operating procedures, the corresponding SCPI commands should be:

INP:SHOR ON ; Sets the load to short circuit operation

MODE CCH ; Sets the mode

INP ON ; Turns on the load

Example 2: Based on the last example, exit the short circuit operation, and turn off the load.

Procedures	Operation Descriptions	Display
1	Press  key to enter into main menu, and select Short (short circuit) item with  key.	Short: *On Off
2	Use  key or knob to set Off, and press  key to confirm.	Short: On *Off
3	Press  key to exit the main menu. On the display, “s” disappears in CCH status.	0.000V 0.000A 0.000A CCH ON
4	Press  key to turn off the load.	0.000V 0.000A 0.000A CCH OFF

For the above operating procedures, the corresponding SCPI commands should be:

INP:SHOR OFF ; Sets the load to exit the short circuit operation

INP OFF ; Turns on the load

#### 4.7 Transient Operation









The operating procedures for transient operation are shown below:

1. Press **Set** key to enter into the mode selection and parameter setting menu; use **▲**, **▼** keys to select one basic operating mode; press **Enter** key to confirm and exit the mode selection and parameter setting menu.
2. Press **Tran** key to enter into transient operation. The display shows “t” to indicate in the basic test mode.
3. Press **Set** key to enter into the transient operation menu.
4. Use **▲**, **▼** keys to select the parameter.
5. Use Entry keys or use the knob together with **◀**, **▶** keys to set values for LevelL, LevelH, TimeL, TimeH, TimeR, and TimeF. Use **◀**, **▶** keys or knob to set Mode value.
6. Press **Clear Prot Clear** key to exit the transient operation menu.
7. Press **Input on/off** key to turn on the load.
8. If it is the pulsed transient operation or the toggled transient operation, one trigger occurs when pressing **2nd** key + **Trigger** key or the signal at the trigger input terminal (TRIG IN) is low level.

#### 4.7.1 Continuous Transient Operation

Example 1: Take 3721A as an example, set the load voltage value to periodically switch between 1V and 5V; set the time for rising edge (TimeR) to 10ms; set high level time (TimeH) to 200ms; set time for falling edge (TimeF) to 20ms; set low level time (TimeL) to 400ms, and the load is in continuous transient operation. The operating procedures are shown as below:

Procedures	Operation Descriptions	Display
1	Press <b>Set</b> key to enter into the mode selection and parameter setting menu; use <b>▲</b> , <b>▼</b> keys to select CV mode; press <b>Enter</b> key to confirm and exit the mode selection and parameter setting menu.	0.000V 0.000A 0.00 <u>0</u> V CV OFF
2	Press <b>Tran</b> key to enter into transient operation. The display shows “t” to indicate in CV mode.	0.000V 0.000A 80.000V tCV OFF
3	Press <b>Set</b> key to enter into the transient operation menu.	▶ LevelL:80.000V LevelH:80.000V

4	Use Entry keys or use the knob together with ◀, ▶ keys to set LevelL to 1, and press  key to confirm.	LevelL:1.000V ▶LevelH:80.000V
5	Use Entry keys or use the knob together with ◀, ▶ keys to set LevelH to 5, and press  key to confirm.	▶TimeL :530.00ms TimeH :500.00ms
6	Use Entry keys or use the knob together with ◀, ▶ keys to set TimeL to 400ms, and press  key to confirm.	TimeL :400.00ms ▶TimeH :500.00ms
7	Use Entry keys or use the knob together with ◀, ▶ keys to set TimeH to 200ms, and press  key to confirm. The menu will show the next item automatically.	▶TimeR: 100.00ms TimeF: 100.00ms
8	Use Entry keys or use the knob together with ◀, ▶ keys to set TimeR to 10ms, and press  key to confirm.	TimeR: 10.00ms ▶TimeF: 100.00ms
9	Use Entry keys or use the knob together with ◀, ▶ keys to set TimeF to 20ms, and press  key to confirm.	▶Mode: ◀ Cont ▶
10	Use ◀, ▶ keys or knob to set Mode value to <b>Cont</b> , and press  key to confirm.	▶Mode: ◀ Cont ▶
11	Press  key to exit the transient operation menu.	0.000V 0.000A 1.000V tCV OFF
12	Press  key to turn on the load.	0.000V 0.000A 1.000V tCV ON  0.000V 0.000A 5.000V tCV ON

For the above operating procedures, the corresponding SCPI commands should be:

MODE CV ; Sets the mode  
TRAN ON ; Enables the transient operation  
VOLT:LOW 1 ; Sets a value to low level  
VOLT:HIGH 5 ; Sets a value to high level  
TRAN:LTIME 400ms ; Sets a value to low level time  
TRAN:HTIME 200ms ; Sets a value to high level time











TRAN:RTIME 10ms ; Sets a value to time for rising edge  
 TRAN:FTIMR 20ms ; Sets a value to time for falling edge  
 TRAN:MODE CONT ; Selects continuous transient operation  
 INP ON ; Turns on the load

#### 4.7.2 Pulsed Transient Operation

Example 1: Assume that the load is in external triggering mode, set the load current value to periodically switch between 1A and 5A; set the time for rising edge (TimeR) to 10ms; set high level time (TimeH) to 200ms; set time for falling edge (TimeF) to 10ms; the load is in pulsed transient operation, and a trigger occurs at this time.

Procedures	Operation Descriptions	Display
1	Press <b>Set</b> key to enter into the mode selection and parameter setting menu; use <b>▲</b> , <b>▼</b> keys to select CCH mode; press <b>Enter</b> key to confirm and exit the mode selection and parameter setting menu.	0.000V 0.000A 0.000A CCH OFF
2	Press <b>Tran</b> key to enter into transient operation. The display shows “t” to indicate in CCH status.	0.000V 0.000A 0.500A tCCH OFF
3	Press <b>Set</b> key to enter into the transient operation menu.	►LevelL: 0.500A LevelH: 1.000A
4	Use Entry keys or use the knob together with <b>◀</b> , <b>▶</b> keys to set LevelL to 1, and press <b>Enter</b> key to confirm.	LevelL: 1.000A ►LevelH: 1.000A
5	Use Entry keys or use the knob together with <b>◀</b> , <b>▶</b> keys to set LevelH to 5, and press <b>Enter</b> key to confirm.	►TimeL: 400.00ms TimeH: 400.00ms
6	Press <b>▼</b> key to select TimeH; use Entry keys or use the knob together with <b>◀</b> , <b>▶</b> keys to set TimeH to 200ms, and press <b>Enter</b> key to confirm.	►TimeR: 10.00ms TimeF: 20.00ms
7	Use Entry keys or use the knob together with <b>◀</b> , <b>▶</b> keys to set TimeR to 10ms, and press <b>Enter</b> key to confirm.	TimeR: 10.00ms ►TimeF: 20.00ms
8	Use Entry keys or use the knob together with <b>◀</b> , <b>▶</b> keys	►Mode: ◀Cont ▶





	to set TimeF to 10ms, and press  key to confirm.	
9	Use  ,  keys or knob to set Mode value to <b>pulse</b> , and press  key to confirm.	► Mode: ◀ Puls ▶
10	Press  key to exit the transient operation menu.	0.000V 0.000A 1.000A tCCH OFF
11	Press  key to turn on the load.	0.000V 0.000A 1.000A tCCH ON
12	Send the command “INIT” or “INIT:CONT” to the load.	
13	One trigger occurs when pressing  +  key or the signal at the trigger input terminal (TRIG IN) is low level.	0.000V 0.000A 5.000A tCCH ON





















For the above operating procedures, the corresponding SCPI commands should be:

MODE CCH ; Sets the mode  
 TRAN ON ; Enables the transient operation  
 CURR:LOW 1 ; Sets a value to low level  
 CURR:HIGH 5 ; Sets a value to high level  
 TRAN:HTIME 200ms ; Sets a value to high level time  
 TRAN:RTIME 10us ; Sets a value to time for rising edge  
 TRAN:FTIME 10us ; Sets a value to time for falling edge  
 TRAN:MODE PULS ; Selects pulsed transient operation  
 INP ON ; Turns on the load  
 INIT ; Initialize the trigger  
 TRIG ; One trigger occurs

### 4.7.3 Toggled Transient Operation

Example 1: Assume that the load is in external triggering mode, set the load resistance value to periodically switch between 200 Ω and 500 Ω ; set the time for rising edge (TimeR) to 10ms; set time for falling edge (TimeF) to 10ms; the load is in toggled transient operation, and a trigger occurs at this time.

Procedures	Operation Descriptions	Display
1	Press  key to enter into the mode selection and parameter setting menu; use  ,  keys to select CRH mode; press  key to confirm and exit the mode selection and parameter setting menu.	0.000V 0.000A 20.000 Ω CRH OFF
2	Press  key to enter into transient operation. The display shows “t” to indicate in CRH status.	0.000V 0.000A 2000.0 Ω tCRH OFF































3	Press  key to enter into the transient operation menu..	►LevelL: 2000.0 Ω LevelH: 2000.0 Ω
4	Use Entry keys or use the knob together with  ,  keys to set LevelL to 200, and press  key to confirm.	LevelL: 200.00 Ω ►LevelH: 2000.0 Ω
5	Use Entry keys or use the knob together with  ,  keys to set LevelH to 500, and press  key to confirm.	►TimeL:400.00ms TimeH:200.00ms
6	Press  key to select TimeR; use Entry keys or use the knob together with  ,  keys to set TimeR to 10ms, and press  key to confirm..	TimeR:10.00ms ►TimeF:10.00ms
7	Use Entry keys or use the knob together with  ,  keys to set TimeF to 10ms, and press  key to confirm.	►Mode: ◀ Puls ▶
8	Use  ,  keys or knob to set Mode value to <b>Togg</b> , and press  key to confirm.	►Mode: ◀Togg ▶
9	Press  key to exit the transient operation menu.	0.000V 0.0000A 200.00 Ω tCRH OFF
10	Press  key to turn on the load.	0.000V 0.0000A 200.00 Ω tCRH ON
11	Send the command “INIT” or “INIT:CONT” to the load.	
12	One trigger occurs when pressing  +  key or the signal at the trigger input terminal (TRIG IN) is low level.	0.000V 0.0000A 500.00 Ω tCRH ON

For the above operating procedures, the corresponding SCPI commands should be:

















MODE CRH ; Sets the mode  
 TRAN ON ; Enables the transient operation  
 RES:LOW 200 ; Sets a value to low level  
 RES:HIGH 500 ; Sets a value to high level  
 TRAN:RTIME 10us ; Sets a value to time for rising edge  
 TRAN:FTIME 10us ; Sets a value to time for falling edge  
 TRAN:MODE TOGG ; Selects toggled operation  
 INP ON ; Turns on the load  
 INIT ; Initialize the trigger  
 TRIG ; One trigger occurs

## 4.8 List Operation









The operating procedures for sequence operation are shown below:

1. Press  key +  key to enter into list operation menu.
2. Use Entry keys or the knob to select list number (No.), and press  key to confirm.
3. Use  key to select list memo (Memo).
4. Use knob and ,  keys to edit memo (max. 10 characters).
5. Use  key to select sequence data (Data:<New/Edit>). Use ,  keys or knob to select New or Edit operation, and press  key to confirm.
6. Select New operation, and press  to enter list data clear screen. Use  or knob to select Yes, and press  to confirm. Now list data will be cleared and the load will enter the step edit screen. Use  or knob to select No, then press  key to confirm and return to the list operation menu.
7. Select Edit, then press  to enter step edit screen.
8. Use ,  to select parameters.
9. Use Entry keys or use the knob together with ,  keys to input set value; or use the knob/ key to select one operating mode, and press  key to confirm. After setting the third parameter, press  key to confirm and enter into the next step.
10. If it is needed to modify one step, use ,  keys to select this step. The setting operations for this step are the same as the operating procedure 9.
11. If it is needed to add one step to the last step, use  key to select the new step. The setting operations for this new step are the same as the operating procedure 9.
12. If it is needed to insert one step above an edited step, use ,  keys to select this edited step. The LCD display doesn't flash at this time, and press  key +  key to insert a new step. The setting operations for this new step are the same as the

operating procedure 9.

13. If it is needed to delete an edited step, use ,  keys to select this step. The LCD display will stop flashing, and press  key +  key to delete. If there is only one step exists, it will exit the step edit screen.
14. Press  key to exit step edit screen, and save the sequence data in EEPROM assigned by the sequence number.
15. Use  key to select the cycle times (Count); use Entry keys or the knob together with ,  keys to input set value. Press  key to confirm and save the cycle times (Count) in EEPROM assigned by the sequence number.
16. Use  key to select “Chain”; use Entry keys (the “Chain” is OFF when the Entry key exceeds 6) or the knob to input the set value. Press  key to confirm.
17. Press  key to exit sequence operation menu.
18. Press  key +  key to activate sequence operation.
19. Press  key +  key to stop sequence operation.



















After sequence editing, the operating procedures for enabling and disabling sequence operation are shown as below:













1. Press  key +  key to enter sequence operation menu.
2. Use Entry keys or the knob to select list number (No.), and press  key to confirm.
3. Press  key to exit sequence operation menu.
4. Press  key +  key to activate sequence operation.
5. Press  key +  key to stop sequence operation.

#### 4.8.1 List Editing

Example 1: Edit a new sequence. The sequence number is 0; the sequence Memo is Test Power; the sequence steps: step1: CCL, 1A, 1S; step2: CCH, 2A, 1S; step3: CV, 1V, 1S; step4: CRL, 1Ω, 1S; step5: CRH, 200Ω, 1S; the cycle times (Count) for sequence operation is 5; disabling the sequence chain; starting sequence operation; stopping sequence operation.

Procedures	Operation Descriptions	Display
------------	------------------------	---------

1	Press  key +  key to enter into sequence operation menu.	▶No.: 0 Memo:
2	Use Entry keys or the knob to set the sequence number (No.) to 0, and press  key to confirm (recall the sequence in EEPROM assigned by the sequence number).	▶No.: 0 Memo:
3	Use  key to select sequence memo (Memo).	No.: 0 ▶Memo: _
4	Rotate the knob to select the letter “T”.	No.: 0 ▶Memo: T
5	Use  key to move the cursor to the right.	No.: 0 ▶Memo: T _
6	Rotate the knob to select the letter “e”.	No.: 0 ▶Memo: Te
7	Set Memo to “Test Power” according to step5 and setp6 operations. Press  key to confirm.	No.: 0 ▶Memo: Test Power
8	Use  key to select Data:<New/Edit>.	▶Data:<New/Edit> Count: 1
9	Use  key or knob to select New, and press  key to confirm.	Clear Data: Yes *No
10	Use  key or knob to select Yes, and press  key to confirm. The data is cleared and step edit screen appears.	01. 0.0000s CCH 0.000A
11	Edit the step1: CCL, 1A, 1S. The time set value in the upper right corner of the display flashes. Use Entry keys or the knob together with  ,  keys to input time to 1s, and press  key to confirm.	01. 1.0000s CCH 0.000A
12	The basic mode showed in lower left corner of the display flashes. Use the knob or  key to select operating mode to CCL, and press  key to confirm.	01. 1.0000s CCL 0.000A
13	The set value in the lower right corner of the display flashes. Use Entry keys or the knob together with  ,  keys to input the current value to 1A. Press  key to confirm and enter into the next operation.	01. 1.0000s CCL 1.000A
14	Repeat the procedures 11 through 13 to set the rest four steps.	



15	The five sequence steps have been edited, and there is no need to edit the step6. Press  key to exit step edit screen and save the sequence data in EEPROM assigned by the sequence number.	06. 0.0000s CRH 20.000 Ω
16	Use  key to select “Count”; use Entry keys or the knob together with  ,  keys to input “5”. Press  key to confirm and save the Count value in EEPROM assigned by the sequence number.	Data:<New/Edit> Count: 5
17	Use  key to select “Chain”; use Entry keys (the “Chain” is OFF when the Entry key exceeds 6) or the knob to input “Off”. Press  key to confirm and save the Chain value in the EEPROM assigned by the sequence number.	►Chain:Off
18	Press  key to exit sequence operation menu.	0.000V 0.000A 0.000A CCH OFF
19	Press  key +  key to activate sequence operation.	0.000V 0.0000A 1.000A iCCL ON
20	Press  key +  key to stop sequence operation.	0.000V 0.000A 0.000A CCH OFF























For the above operating procedures, the corresponding SCPI commands should be:

LIST: NUMB 0 ; Recalls the number 0 sequence  
LIST: MEMO “Test Power” ; Sequence memo is “Test Power”  
LIST: ADD CCL,1A,1S  
LIST: ADD CCH,2A,1S  
LIST: ADD CV,1V,1S  
LIST: ADD CRL,1 Ω ,1S  
LIST: ADD CRH,200 Ω ,1S ; The above 5 commands are sequence steps  
LIST: COUNT 5 ; Cycle times for this sequence  
LIST: CHA OFF ; Disables the chained sequence  
LIST ON ; Activates sequence operation  
LIST OFF ; Stops sequence operation



#### 4.8.2 Modifying, Adding, Inserting, Deleting the List

Exampel 1: Based on the example1 in 4.8.1 section, the step 1 modify the time to 2s. Add “CCH, 5A, 1S” to the last step. Insert “CRL , 1 Ω ,10S” at step3. Delete step2. The sequence is chained to itself to realize the continuous execution.

Steps	Operation Descriptions	Display
Step1	Press  key +  key to enter into sequence operation	►No.: 0 Memo: Test Power

	menu.	
Step2	Use  key to select Data:<New/Edit>.	►Data:<New/Edit> Count: 5
Step3	Use  key or knob to select Edit, and press  key to confirm and enter step edit screen.	01. 1.0000s CCL 1.000A
Step4	Use  key to select time parameter, and the time set value flashes.	01. 1.0000s CCL 1.000A
Step5	Use Entry keys or the knob together with  ,  keys to input the time to 2s, and press  key to confirm.	01. 2.0000s CCL 1.000A
Step6	Use  key to select the last new step (Step6).	06. 0.0000s CRH 20.000 Ω
Step7	Add a new step: CCH, 5A, 1S. The set value in the upper right corner of the display flashes. Use Entry keys or the knob together with  ,  keys to input time to 1s, and press  key to confirm.	06. 1.0000s CRH 20.000 Ω
Step8	The basic mode showed in lower left corner of the display flashes. Use the knob or  key to select operating mode to CCH, and press  key to confirm.	06. 1.0000s CCH 0.000A
Step9	The set value in the lower right corner of the display flashes. Use Entry keys or the knob together with  ,  keys to input the current value to 5A. Press  key to confirm and enter into the next operation.	06. 1.0000s CCH 5.000A 07. 0.0000s CCH 0.000A
Step10	Use  key to select the step3.	03. 1.0000s CV 1.000V
Step11	Press  key +  key to insert a new step at step3.	03. 0.0000s CV 0.000V
Step12	Insert a new step: CRL, 1 Ω, 10S at step3. The setting operations for this new step are the same as the operating procedures7 to 9.	03. 10.0000s CRL 1.0000 Ω
Step13	Use  key to select the step2.	02. 1.0000s CCH 2.000A
Step14	Press  key +  key to delete the step2.	02. 10.0000s CRL 1.0000 Ω
Step15	Press  key to exit step edit screen and save the sequence data in EEPROM assigned by the sequence number.	►Data:<New/Edit> Count: 5











Step16	Use  key to select Chain.	►Chain: Off
Step17	Use Entry keys or the knob to input 0 (it is chained to itself to realize continuous execution). Press  key to confirm and save the Chain value in EEPROM assigned by the sequence number.	►Chain: 0
Step18	Press  key to exit sequence operation menu.	0.000V 0.000A 0.000A CCH OFF

For the above operating procedures, the corresponding SCPI commands should be:

LIST:NUMB 0 ; Recalls the number 0 sequence  
LIST:EDIT 1,CCL,1A,2S ; Modifies the time of Step1 to 2S  
LIST:ADD CCH,5A,1S ; Add CCH, 5A, 1S to the last step  
LIST:INS 3,CRL, 1Ω,10S ; Inserts the third step  
LIST:DEL 2 ; Deletes the second step  
LIST:CHA 0 ; Chians itself  
LSIT:SAVE ; Saves list  
LIST ON ; Enables list operation  
LIST OFF ; Disables list operation

### 4.8.3 Starting/Stopping the List

Example 1: Start the No.0 sequence, and stop the active sequence operation.

Steps	Operation Descriptions	Display
Step1	Press  key +  key to enter into sequence operation menu.	►No.: <u>1</u> Memo:
Step2	Use Entry keys or knob to set the sequence number (No.) to 0, and press  key to confirm (recall the sequence in EEPROM assigned by the sequence number).	►No.: <u>0</u> Memo: Test Power
Step3	Press  key to exit sequence operation menu.	0.000V 0.000A 0.00 <u>0</u> A CCH OFF
Step4	Press  key +  key to activate sequence operation.	0.000V 0.0000A 1.0000A LCCCL ON
Step5	Press  key +  key to stop sequence operation.	0.000V 0.000A 0.00 <u>0</u> A CCH OFF

For the above steps, the corresponding SCPI commands should be:

LIST: NUMB 0 ; Recalls the number 0 sequence  
LIST ON ; Starts sequence operation  
LIST OFF ; Stops sequence operation

## 4.9 Battery Discharge Operation

Battery discharge operation diagram:

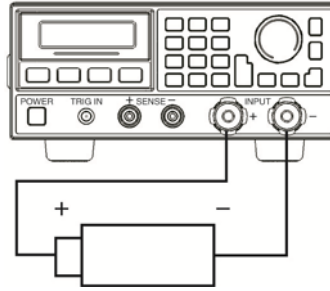













The operating procedures for battery discharge operation are shown below:

1. Press **Input on/off** key to turn off the load, and connect the tested battery correctly.
2. Press **2nd** key + **6 Battery** key to enter into battery discharge operation screen.
3. Press **Set** key to enter into battery discharge parameters edit screen. Use **▲**, **▼** keys to select the parameter. Use Entry keys or the knob together with **◀**, **▶** keys to input termination voltage value and discharge current value. Press **Enter** key to confirm.
4. Press **Clear Prot Clear** key to exit the battery discharge parameters edit screen.
5. Press **Input on/off** key to turn on the load, and start battery discharge operation.
6. Press **Input on/off** key to turn off the load, and stop battery discharge operation.
7. Press **Clear Prot Clear** key to clear the discharged time and discharged capacity of the battery.
8. Press **2nd** key + **6 Battery** key to exit the battery discharge operation.

Example 1: Enter into the battery discharge operation; set the termination voltage to 15V, and the discharge current to 3A; turn on the load, and start the battery discharge operation; turn off the load and stop the battery discharge operation; clear the discharged time and discharged capacity of the battery; exit the battery discharge operation.

Steps	Operation Descriptions	Display
Step1	Press <b>Input on/off</b> key to turn off the load, and connect the tested battery correctly.	20.000V 0.000A 0.000A CCH OFF
Step2	Press <b>2nd</b> key + <b>6 Battery</b> key to enter into battery discharge operation screen.	20.000V 0.000A 0.000AH 00:00:00
Step3	Press <b>Set</b> key to enter into battery discharge parameters edit	▶MinVolt:0.000V DisCurr:2.000A





	screen. Use Entry keys or the knob together with  ,  keys to input termination voltage to 15V. Press  key to confirm.	
Step4	Use Entry keys or the knob together with  ,  keys to input discharge current to 3A. Press  key to confirm.	MinVolt:15.000V DisCurr:3.000A
Step5	Press  key to exit the battery discharge parameters edit screen.	20.000V 0.000A 0.000AH 00:00:00
Step6	Press  key to turn on the load, and start battery discharge operation.	20.000V 3.000A 0.000AH 00:00:01
Step7	Press  key to turn off the load, and stop battery discharge operation.	20.000V 0.000A 0.012AH 00:00:15
Step8	Press  key to clear the discharged time and discharged capacity of the battery.	20.000V 0.000A 0.000AH 00:00:00
Step9	Press  key +  key to exit the battery discharge operation.	20.000V 0.000A 0.000A CCH OFF

For the above operating procedures, the corresponding SCPI commands should be:

INP OFF ; Turns off the load  
 BATT ON ; Activates the battery discharge operation screen  
 BATT:TERM:VOLT 15V ; Sets termination voltage to 15V  
 BATT:CURR 3A ; Sets discharge current to 3A  
 INP ON ; Turns on the load, and start battery discharge operation  
 INP OFF ; Turns off the load, and stop battery discharge operation  
 BATT OFF ; Exits the battery discharge operation



#### 4.10 Saving and Recalling

The operating procedures for saving and recalling operation are shown below:

1. Press  key +  key to enter into the saving menu, or press  key +  key to enter into the recalling menu.
2. Press Entry keys or the knob to select saving or recalling position.
3. Press  key to confirm and exit the saving or recalling menu. If the saving is selected, the values of List 2-1 parameters will be saved in the specified location in EEPROM; if the recalling is selected, the values of List 2-1 parameters should be the values saved in specified location in EEPROM.

Example 1: Set the mode to CCL; set the current value to 2A; turn on the load; save the settings in Location 0 in EEPROM; the next time the load is turned on, these settings will become the



power-on settings.

Procedures	Operation Descriptions	Display
1	Set the mode to CCL; set the current value to 2A; turn on the load (please refer to 4.5.1 for detailed operations).	0.000V 0.000A 2.000 <u>0</u> A CCL ON
2	Press  key +  key to enter into the saving menu.	Save File No. <u>1</u>
3	Press Entry keys or the knob to select the Location 0 for saving.	Save File No. <u>0</u>
4	Press  key to confirm and exit the load saving menu.	0.000V 0.000A 2.0000A CCL ON

For the above operating procedures, the corresponding SCPI commands should be:

MODE CCH ; Sets the load to CCH status  
 CURR 2 ; Sets the current value to 2A  
 INP ON ; Turns on the loas  
 \*SAV 0 ; Saves the present settings in Location 0 in EEPROM

Example 2: Based on the above example, set the mode to CV; set the voltage value to 40V; turn off the load; recall the values saved in Location 0 in EEPROM. The detailed operations are shown below:



Procedures	Operation Descriptions	Display
1	Set the mode to CV; set the voltage value to 40V; turn off the load (please refer to 4.5.2 section for detailed operations).	0.000V 0.000A 40.00 <u>0</u> V CV OFF
2	Press  key +  key to enter into the recalling menu.	Recall File: No. <u>0</u>
3	Press Entry keys or the knob to select the recalled Location 0.	Recall File: No. <u>0</u>
4	Press  key to confirm and return.	0.000V 0.000A 2.0000A CCL ON

For the above operating procedures, the corresponding SCPI commands should be:

MODE CV ; Sets the CV mode  
 VOLT 40 ; Sets the voltage value to 40V  
 INP OFF ; Turns off the load  
 \*RCL 0 ; Recalls the values saved in location 0 in EEPROM



#### 4.11 Clearing Protection Settings

The operating procedures for clear protection settings are shown below:

1. Eliminate the reason that causes the protection status.
2. Press  key +  key.

Example 1: Clear RV protection of the load. The detailed operations are shown below:



Procedures	Operation Descriptions	Display
1	Connect the power supply to the load again.	0.000V 0.0000A 2.000 <u>0</u> A RV OFF

2	Press  key +  key.	0.000V    0.0000A 2.0000A    CCL OFF
---	--	---



For the above operating procedures, the corresponding SCPI commands should be:  
INP:PROT:CLE ; Clears the protection status

#### 4.12 Error Messages

When an error occurs to the load, the operating procedures are shown below:

1. Press  key +  key to display the error messages.



Example 1: When a wrong command is sent, the ERR annunciator will turn red. Check the error message. The detailed operations are shown below:

Procedures	Operation Descriptions	Display
1	Press  key +  key to display the error message.	ERROR -103
2	If there are still errors that have not been examined, repeat the first operation.	
3	If all errors have been checked, the ERR annunciator will be turned off. If repeat the first operation right now, display will shows “NO ERROR”.	NO ERROR







For the above operating procedures, the corresponding SCPI commands should be:  
SYST:ERR? ; Queries the error code and error messages

#### 4.13 Triggered Operation

When the triggering mode is EXTERNAL, the triggered operations are shown below:

1. Set pending trigger function (please see 2.8 section for detailed introduction).
2. Initialize the trigger.
3. Press  key +  key or trigger terminal (TRIG IN) to receive TTL falling edge, and a trigger occurs.

Example 1: Select “List” for the trigger function to trigger a sequence operation. The sequence is the one mentioned in Example 1 in 4.8.1 section. The detailed operations are shown below:









Steps	Operation Descriptions
Step1	Select “List” in main menu for the trigger function (please see 4.14.6 for detailed introduction).
Step2	Send the command “INIT” or “INIT:CONT” to the load.
Step3	Press  key +  key or trigger terminal (TRIG IN) to receive TTL falling edge. The load’s input will change accordingly when the sequence parameters are changed. Pressing  key +  key has the same effect as pressing  key +  key at this time.

For the above operating procedures, the corresponding SCPI commands should be:

TRIG:FUNC LIST ; Selects "LIST" for trigger function  
 "INIT" ; Initialize the trigger  
 TRIG ; A trigger occurs





#### 4.14 Main Menu

The operating procedures for the main menu are shown below:

1. Press  key to enter into the main menu.
2. Use ,  keys to select the menu item.
3. Use the knob or ,  keys to select the parameter; or use Entry keys or the knob together with  keys to input set value. Press  key to exit the parameter modification or exit the main menu.
4. Press  key to confirm.
5. Press  key to exit the main menu.







##### 4.14.1 Loading Default Values





Example: Load the default values. The detailed operations are shown below:

Procedures	Operation Descriptions	Display
1	Press  key to enter into the main menu.	Load Default: Yes *No
2	Use the knob or  key to select the parameter "Yes". Press  key to confirm.	Load Default: *Yes No
3	Press  key to exit the main menu.	

##### 4.14.2 Short Circuit Operation

Example: Short circuit operation in CV mode. The detailed operations are shown below:

Procedures	Operation Descriptions	Display
1	Press  key to enter into the main menu.	Load Default: Yes *No
2	Use  key to select the menu item "Short"; use the knob or  key to select the parameter "On". Press  key to confirm.	Short *On Off
3	Press  key to exit the main menu.	
4	Press  key to enter into the mode selection and parameter	0.000V 0.000A 0.000V sCV OFF

	setting menu; use  ,  keys to select CV mode. Press  key to confirm and exit the mode selection and parameter setting menu.	
5	Press  key to turn on the load.	0.000V 0.000A 0.000V sCV ON

For the above operating procedures, the corresponding SCPI commands should be:











INP:SHORT ON ; Sets the load to short circuit

MODE CV ; Sets the mode

INP ON ; Turns on the load

#### 4.14.3 Von Point/Von Latch

Example: Set the Von Latch to Off; set Von Point to 1V; turn on the load; This example implements the automatic turning on/off of the load's input, which simplifies the test operations greatly. The detailed operations are shown below:

Procedures	Operation Descriptions	Display
1	Press  key to enter into the main menu.	Load Default: Yes *No
2	Use  key to select the menu item "Von Latch"; use the knob or  key to select the parameter "Off". Press  key to confirm.	Von Latch: *On Off
3	Use  key to select the menu item "Von Point"; use Entry keys or the knob together with  ,  keys to input the voltage value. Press  key to confirm.	Von Point: 1.000V
4	Press  key to exit the main menu.	0.000V 0.000A 0.000A CCH OFF
5	Press  key to turn on the load.	0.000V 0.000A 0.000A CCH ON

For the above steps, the corresponding SCPI commands should be:

INP: LATCH OFF ; Disables the Von Latch







INP: LATCH:VOLT 1 ; Sets the Von voltage point to 1V

INP ON ; Turns on the load

#### 4.14.4 Current Limit in CV Mode

Example: Set the load to CV mode; set the voltage value to 2V; set the current limit value in CV mode (CV Curr Limit) to 20A; turn on the load. The detailed operations are shown below:

Procedures	Operation Descriptions	Display
step1	Set the load to CV mode, and set the voltage value to 2V (please	0.000V 0.000A











	see 4.5.2 section for detailed operations)	2.00 <u>0</u> V CV OFF
Step2	Press  key to enter into the main menu.	Load Default: Yes *No
Step3	Use  key to select the menu item “CV Curr Limit”; use Entry keys or the knob together with  ,  keys to input the current limit value to 20A. Press  key to confirm.	CV Curr Limit: 20.000A
Step4	Press  key to exit the main menu.	0.000V 0.000A 2.00 <u>0</u> A CCH OFF
Step5	Press  key to turn on the load.	0.000V 0.000A 2.00 <u>0</u> A CCH ON

For the above operating procedures, the corresponding SCPI commands should be:

MODE CV ; Sets the mode  
VOLT 2 ; Sets the current value to 2V  
INP:LIM:CURR 20A ; Sets the current limit value to 20A in CV mode  
INP ON ; Turns on the load

#### 4.14.5 Current Rise/Fall Rate in CC Mode

Example: Set the load to CCH mode, set the current value to 2A; set the current rise rate (Curr Rise Rate) in CC mode to 0.002A/us; set the current fall rate (Curr Fall Rate) in CC mode to 0.005A/us; turn on the load; turn off the load. The detailed operations are shown below:

Procedures	Operation Descriptions	Display
1	Set the load to CCH mode, and set the current value to 2A.	0.000V 0.000A 2.00 <u>0</u> A CCH OFF
2	Press  key to enter into the main menu.	Load Default: Yes *No
3	Use  key to select the menu item “Curr Rise Rate”; use Entry keys or the knob together with  ,  keys to input the current value to 0.002A/us. Press  key to confirm.	Curr Rise Rate: 0.00 <u>2</u> A/us
4	Use  key to select the menu item “Curr Fall Rate”; use Entry keys or the knob together with  ,  keys to input the current value to 0.005A/us. Press  key to confirm.	Curr Fall Rate: 0.00 <u>5</u> A/us
5	Press  key to exit the main menu.	0.000V 0.000A 2.00 <u>0</u> A CCH OFF
6	Press  key to turn on the load.	0.000V 0.000A 2.00 <u>0</u> A CCH ON







7	Press  key to turn off the load.	0.000V 0.000A 2.000A CCH OFF
---	---	---------------------------------

For the above operating procedures, the corresponding SCPI commands should be:

MODE CCH ; Sets the mode  
 CURR 2 ; Sets the current value to 2A  
 CURR:RISE:RATE 0.002 ; Sets the current rise rate in CC mode to 0.002A/us  
 CURR:FALL:RATE 0.005 ; Sets the current fall rate in CC mode to 0.005A/us  
 INP ON ; Turns on the load  
 INP OFF ; Turns off the load

#### 4.14.6 Trigger Function Selection

Example: Select “Tran” in trigger function selection (Trig Function).





Procedures	Operation Descriptions	Display
1	Press  key to enter into the main menu.	Load Default: Yes *No
2	Use  key to select the menu item “Trig Function”; use the knob or  key to select the parameter “Tran”. Press  key to confirm.	Trig Function: *Tran List
3	Press  key to exit the main menu.	0.000V 0.000A 0.000A CCH OFF

For the above operating procedures, the corresponding SCPI commands should be:

TRIG:FUNC TRAN ; Selects transient operation (TRAN) for trigger function



#### 4.14.7 Knob Function



Example: Enable the knob function.

Procedures	Operation Descriptions	Display
1	Press  key to enter into the main menu.	Load Default: Yes *No
2	Use  key to select the menu item “Knob”; use the knob or  key to select the parameter “On”. Press  key to confirm.	Knob: *On Off
3	Press  key to exit the main menu.	0.000V 0.000A 0.000A CCH OFF

#### 4.14.8 Key Sound





















Example: Enable the key sound.

Procedures	Operation Descriptions	Display
1	Press  key to enter into the main menu.	Load Default: Yes *No
2	Use  key to select the menu item “Key Sound”; use the knob	Key Sound: *On Off









	or  key to select the parameter “On”. Press  key to confirm.	
3	Press  key to exit the main menu.	0.000V 0.000A 0.000A CCH OFF

#### 4.14.9 Communication Interface

Example 1: Select RS232 interface; set the baud rate to 9600; set parity check to None; set data bit to 8; set stop bit to 2; enable the flow control.

Steps	Operation Descriptions	Display
Step1	Press  key to enter into the main menu.	Load Default: Yes *No
Step2	Use  key to select the menu item “Interface”; use the knob or  key to select the parameter “RS232”. Press  key to confirm.	Interface: *RS232 USB GPIB
Step3	Use  key to select the menu item “Baud Rate”; use the knob or  ,  keys to select the parameter “9600”. Press  key to confirm.	Baud Rate: *9600 19200
Step4	Use  key to select the menu item “Parity Check”; use the knob or  key to select the parameter “None”. Press  key to confirm.	Parity Check: *None Even Odd
Step5	Use  key to select the menu item “Data Bit”; use the knob or  key to select the parameter “8”. Press  key to confirm.	Data Bit: *8 7
Step6	Use  key to select the menu item “Stop Bit”; use the knob or  key to select the parameter “2”. Press  key to confirm.	Stop Bit: 1 *2
Step7	Use  key to select the menu item “Flow Control”; use the knob or  key to select the parameter “On”. Press  key to confirm.	Flow Control: *On Off
Step8	Press  key to exit the main menu.	0.000V 0.000A 0.000A CCH OFF

Example 2: Select GPIB interface, set the address to 18.

Steps	Operation Descriptions	Display
Step1	Press  key to enter into the main menu.	Load Default: Yes *No
Step2	Use  key to select the menu item “Interface”; use the knob or  key to select the parameter “GPIB”. Press  key to confirm.	Interface: RS232 USB *GPIB
Step3	Use  key to select the menu item “GPIB Address”; use Entry keys or the knob together with  ,  keys to select the parameter “18”. Press  key to confirm.	GPIB Address: 18
Step4	Press  key to exit the main menu.	0.000V 0.000A 0.000A CCH OFF

## Chapter5 Remote Programming Operation

ARRAY 372x Series Electronic Load supports both local operation and remote control. The previous chapter has introduced how to use the front panel keys and knobs to operate on the load. This chapter will introduce you to how to program the load from the remote controller. The similarities between local and remote programming will become apparent as you read this chapter.

The intent of this chapter is to help users quickly become familiar with remote programming operations. Programming examples given in this chapter use the SCPI commands in their simplest form. Please refer to the “ARRAY 372x Series Electronic Load SCPI Programming Guide” for detailed introduction of all SCPI commands.

### 5.1 Communication Interface

#### 5.1.1 RS232

RS232 interface is standard. Use the cable shipped with the load to connect the load to a computer correctly. Select RS232 interface in the MENU, and set the baud rate, parity, data bit, stop bit, and flow control parameters to be used. Set the same parameters in the software on the computer, and input the right SCPI command to operate the load.

#### 5.1.2 USB

USB interface is optional. It can be used only when the load has installed USB communication module and the relevant driver has installed on the computer. Use USB cable to connect the load to a computer correctly. Select the USB interface in the MENU and input the right SCPI command to operate the load.





### 5.1.3 GPIB

GPIB is optional. It can be used only when the load has installed GPIB communication module and the relevant driver has installed on the computer. Use GPIB cable to connect the load to a computer correctly. Select the GPIB interface in the MENU, and set GPIB address. Each instrument you connect to the GPIB interface has a unique address assigned to it. Input the right SCPI command to operate the load.

### 5.2 Flow Control Selection

When RS232 interface is used, the flow control can be enabled or disabled. The load provides two options: ON and OFF. ON: enabling the flow control; OFF: disabling the flow control. When “OFF” is selected for flow control, the lower baud rate should be set to ensure normal communication.

### 5.3 Remote Control Annunciators

There is a REM annunciator on the front panel of the load. When the load receives the remote command (SYSTEM:REMOte) via RS232 or GPIB interface, the REM annunciator turns on. And the load enters remote control status. In this status, all operations on the load are controlled by the remote controller; the front panel keypad and knob has no effect (except  key +  key). The REM remote control annunciator turns off and the load returns to the local control after receiving the command to return to local control (e.g. SYSTem:LOCal). Or you can return the load to local control from remote control by pressing  key +  key.

### 5.4 Sending a Remote Command

You can use the computer to set operation mode and operation parameters remotely for the load.

### 5.5 Returning Data

The load can return the values of parameter settings, input voltage and current, as well as input power to computer. It can also return information relating to the internal operation and module identification. For example: the query command ( “MEAS:CURR?”) asks the load to return the actual current at the Input binding posts. Please refer to “ARRAY 372x Series Electronic Load SCPI Programming Guide” for detailed information on using query commands. The load stores the response to the query in an output buffer which will hold the information until it is read by the computer or is replaced with new information.

### 5.6 Remote Programming Commands

The SCPI commands have many optional key words for the programmer. Getting familiar with those key words will help you to know the programming better. Most of the commands have a query syntax which allows the present parameter settings to be returned to the controller. Please refer to “ARRAY 372x Series Electronic Load SCPI Programming Guide” for details. The load` s major functions can be programmed with a relatively few number of these commands. The following points are important to remember when you are remotely programming CC, CR, CV, and CP values.

#### 5.6.1 Modes

The CC, CR, CV, and CP values can be programmed whether or not the associated mode is active. If the input is turned on, all of the applicable values will take effect at the input when the associated mode is selected.

### 5.6.2 Transient Levels

The transient CC, CV, or CR level must be set to a higher level than the respective low level, or the transient operation will be disabled.

### 5.6.3 Programmable Current Protection

When programmable current protection is enabled, and the programmed current limit and time delay are exceeded, the load's input will be turned off.

### 5.7 CC Mode Examples

This example sets the current level to 0.5A, and then reads back the actual current value.

- 1 "INP OFF" ; Turns off the load's input
- 2 "MODE CCL" ; Selects the CCL mode
- 3 "CURR 0.5" ; Sets current level to 0.5A
- 4 "INP ON" ; Turns on the load's input
- 5 "MEAS:CURR?" ; Measures the actual input current

### 5.8 CV Mode Examples

This example presets the trigger voltage to 5V, and selects the external trigger source.

- 1 "INP OFF" ; Turns off the load's input
- 2 "MODE CV" ; Selects the CV mode
- 3 "VOLT:TRIG 5" ; Presets the trigger voltage to 5V
- 4 "TRIG:SOUR EXT" ; Selects the external input as the trigger source
- 5 "INP ON" ; Turns on the load's input

In this example, when the external trigger signal is received, the input voltage will be set to 5V.

### 5.9 CR Mode Examples

This example sets the current protection limit to 3A, sets the time delay to 10s, programs the resistance level to 10  $\Omega$ , and reads back the computed power.

1. "INP OFF" ; Turns off the load's input
2. "MODE CRM" ; Selects the CRM mode
3. "CURR:PROT 3" ; Sets the current protection limit to 3A
4. "CURR:PROT:DEL 10" ; Sets the current protection delay time to 10 seconds
5. "CURR:PROT:STAT ON" ; Activates the current protection
- 6 "RES 10" ; Sets resistance level to 10  $\Omega$
7. "INP ON" ; Turns on the load's input
8. "MEAS:POW?" ; Measures the input power level

### 5.10 Continuous Transient Operation Example

This example sets CV transient high/low levels, times for transient rising/falling edge, high/low level times, and parameters for transient operation.

- 1 "INP OFF" ; Turns off the load` s input
- 2 "MODE CV" ; Selects the CV mode
- 3 "VOLT:LOW 0.5" ; Sets the transient low level to 0.5V
- 4 "VOLT:HIGH 1" ; Sets the transient high level to 1V
- 5 "TRAN:LTIM 200us" ; Sets transient low level time to 200us
- 6 "TRAN:HTIM 300us" ; Sets transient high level time to 300us
- 7 "TRAN:RTIM 10us" ; Sets the time for transient rising edge to 10us
- 8 "TRAN:FTIM 20us" ; Sets the time for transient falling edge to 20us
- 9 "TRAN:MODE CONT " ; Selects the continuous transient operation
- 10 "TRAN ON" ; Activates the transient operation
- 11 "INP ON" ; Turns on the load` s input

**5.11 Pulsed Transient Operation Example**

This example selects CV pulsed transient operation, selects the bus as the trigger source, and programs a pulse width of 1 millisecond.

- 1 "INP OFF" ; Turns off the load` s input
- 2 "MODE CV" ; Selects the CV mode
- 3 "TRIG:SOUR BUS" ; Selects the bus as the trigger source
- 4 "VOLT LOW 0.5" ; Sets the transient low level to 0.5V
- 5 "VOLT:HIGH 1" ; Sets the transient high level to 1V
- 6 "TRAN:HTIM 1ms" ; Sets transient high level time to 1ms
- 7 "TRAN:RTIM 10us" ; Sets the time for transient rising edge to 10us
- 8 "TRAN:FTIM 10us" ; Sets the time for transient falling edge to 10us
- 9 "TRAN:MODE PULSE " ; Selects the pulsed transient operation
- 10 "TRAN ON" ; Activates the transient operation
- 11 "INP ON" ; Turns on the load` s input
- 12 "INIT" ; Initialize the trigger
- 13 "\*TRG" ; \*TRG command generates a 1millisecond high-level pulse at the

load`s input

**Specifications**

(The warm-up time is 30 minutes. Specifications indicate warranted performance in the 25°C ± 5°C region of the total temperature range.)

<b>Model</b>	3720A	3721A
<b>Input Ratings</b>		

Current Voltage Power*1	0~30A 0~80V 250W at 40°C	0~40A 0~80V 400W at 40°C
<b>Input Characteristics</b>		
Input Characteristics		
Minimum Operation Voltage @ Full Scale Current	0.6V	0.6V
<b>Constant Current Mode</b>		
Low Range Resolution Accuracy	0~3A 0.1mA 0.1%+5mA	0~4A 0.1mA 0.1%+5mA
High Range Resolution Accuracy	0~30A 1mA 0.1%+10mA	0~40A 1mA 0.1%+10mA
<b>Constant Voltage Mode</b>		
Range Resolution Accuracy	0~80V 1mV 0.1%+10mV	0~80V 1mV 0.1%+10mV
<b>Constant Resistance Mode</b>		
Low Range Resolution Accuracy @I>4A	0.02~2Ω 0.1mΩ 0.5%+12mΩ	0.02~2Ω 0.1mΩ 0.5%+12mΩ
Middle Range Resolution Accuracy @V>8V	2~200Ω 8.6μS*2 0.3%+1.25mS	2~200Ω 8.6μS 0.3%+1.25mS
High Range Resolution Accuracy @V>8V	20~2000Ω 0.96μS 0.3%+0.625mS	20~2000Ω 0.96μS 0.3%+0.625mS
<b>Constant Power Mode</b>		

Range	0~250W	0~400W
Resolution @P<100W	1mW	1mW
@P≥100W	10mW	10mW
Accuracy	0.2%+600mW	0.2%+600mW
<b>Current Measurement</b>		
Low Range	0~3A	0~4A
Resolution	0.1mA	0.1mA
Accuracy	0.05%+4mA	0.05%+4mA
High Range	0~30A	0~40A
Resolution	1mA	1mA
Accuracy	0.05%+8mA	0.05%+8mA
<b>Voltage Measurement</b>		
Range	0~80V	0~80V
Resolution	1mV	1mV
Accuracy	0.1%+8mV	0.1%+8mV
<b>Power Measurement</b>		
Range	0~250W	0~400W
Resolution @P<100W	1mW	1mW
@P≥100W	10mW	10mW
Accuracy	0.1%+600mW	0.1%+600mW
<b>Current Slew Rates</b>		
Range CCH	1mA/us~3A/us	1mA/us~4A/us
CCL <sup>*3</sup>	100uA/us~300mA/us	100uA/us~400mA/us
Resolution	1mA/us	1mA/us
Accuracy <sup>*4</sup>	3% + 10us	3% + 10us
<b>Transient Operation</b>		
Transient Mode	Continuous, Pulse, Toggled	Continuous, Pulse, Toggled
Frequency Range <sup>*5</sup>	0.38Hz~50kHz	0.38Hz~50kHz
High/Low Time	0~655.35ms	0~655.35ms
Resolution	10us	10us
Accuracy	0.2%+10us	0.2%+10us
Rising/Falling Time	10us~655.35ms	10us~655.35ms
Resolution	10us	10us
Accuracy	0.2%+10us	0.2%+10us
<b>List Characteristics</b>		



Step Time Resolution Accuracy	10us~100000s 10us 0.2%+10us	10us~100000s 10us 0.2%+10us
Number of Steps	1~50	1~50
Cycle	1~65535	1~65535
Store Capacity	7 lists	7 lists
Expanded Functions	Chain	Chain
<b>Battery Discharge</b>		
Discharge Time Resolution Accuracy	1s~100h 1s 0.2%+1s	1s~100h 1s 0.2%+1s
Battery Capacity Resolution Accuracy	1mAh~3000Ah 1mAh 0.3%+0.01Ah	1mAh~4000Ah 1mAh 0.3%+0.01Ah
<b>Short Circuit</b>		
CCL Mode	3.3A	4.4A
CCH Mode	33A	44A
CV Mode	0V	0V
CRL Mode	0.018Ω	0.018Ω
CRM Mode	1.8Ω	1.8Ω
CRH Mode	18Ω	18Ω
CPV Mode	270W	420W
CPC Mode	0W	0W
<b>Maximum Slew Rate</b>		
Current Voltage	3A/us 0.6V/us	4A/us 0.6V/us
<b>Programmable Open Circuit</b>	≥20kΩ	≥20kΩ
<b>Trigger Input</b>		
Trigger Level Trigger Pulse Width	TTL falling edge ≥10us	TTL falling edge ≥10us
<b>Maximum DC Input</b>		
Current Voltage	33A 84V	44A 84V
<b>Protection Features</b>	OV, OC, OP, OT, RV	OV, OC, OP, OT, RV
<b>Reverse Current Capacity</b>		
Input OFF Input ON	25A 40A	30A 50A
<b>Ripple and Noise</b>		
Current(rms/p-p) Voltage(rms)	3mA/30mA 5mV	3mA/30mA 5mV

<b>Environmental Conditions</b>		
Temperature	0~50°C	0~50°C
Relative Humidity	≤85%	≤85%
<b>Remote Interface</b> *6	RS232, GPIB, USB	RS232, GPIB, USB
<b>Programming Language</b>	SCPI	SCPI
<b>AC Input</b>		
Voltage	AC110V or AC220V±15%	AC110V or AC220V±15%
Frequency	48 to 63Hz	48 to 63Hz
<b>Net Weight</b>	5.8kg	5.8kg

<b>Model</b>	3722A	3723A
<b>Input Ratings</b>		
Current	0~20A	0~30A
Voltage	0~200V	0~200V
Power*1	200W at 40°C	350W at 40°C
<b>Input Characteristics</b>		
Input Characteristics		
Minimum Operation Voltage @ Full Scale Current	1.2V	1.2V
<b>Constant Current Mode</b>		
Low Range	0~2A	0~3A
Resolution	0.1mA	0.1mA
Accuracy	0.1%+5mA	0.1%+5mA
High Range	0~20A	0~30A
Resolution	1mA	1mA
Accuracy	0.1%+10mA	0.1%+10mA
<b>Constant Voltage Mode</b>		
Range	0~200V	0~200V
Resolution	2mV	2mV
Accuracy	0.1%+25mV	0.1%+25mV
<b>Constant Resistance Mode</b>		

Low Range Resolution Accuracy @I>3A	0.0666~6.66 Ω 0.1mΩ 0.5%+40mΩ	0.0666~6.66 Ω 0.1mΩ 0.5%+40mΩ
Middle Range Resolution Accuracy @V>20V	6.66~666 Ω 2.6uS 0.3%+375uS	6.66~666 Ω 2.6uS 0.3%+375uS
High Range Resolution Accuracy @V>20V	66.6~6660 Ω 0.29uS 0.3%+188uS	66.6~6660 Ω 0.29uS 0.3%+188uS
<b>Constant Power Mode</b>		
Range Resolution @P<100W @P≥100W Accuracy	0~200W 1mW 10mW 0.2%+600mW	0~350W 1mW 10mW 0.2%+600mW
<b>Current Measurement</b>		
Low Range Resolution Accuracy	0~2A 0.1mA 0.05%+4mA	0~3A 0.1mA 0.05%+4mA
High Range Resolution Accuracy	0~20A 1mA 0.05%+8mA	0~30A 1mA 0.05%+8mA
<b>Voltage Measurement</b>		
Range Resolution Accuracy	0~200V 1mV 0.1%+50mV	0~200V 1mV 0.1%+50mV
<b>Power Measurement</b>		
Range Resolution @P<100W @P≥100W Accuracy	0~200W 1mW 10mW 0.1%+600mW	0~350W 1mW 10mW 0.1%+600mW
<b>Current Slew Rates</b>		
Range CCH CCL <sup>*3</sup>	1mA/us~2A/us 100uA/us~200mA/us	1mA/us~3A/us 100uA/us~300mA/us
Resolution	1mA/us	1mA/us
Accuracy <sup>*4</sup>	3% + 10us	3% + 10us
<b>Transient Operation</b>		
Transient Mode	Continuous, Pulse, Toggled	Continuous, Pulse, Toggled

Frequency Range *5	0.38Hz~50kHz	0.38Hz~50kHz
High/Low Time Resolution Accuracy	0~655.35ms 10us 0.2%+10us	0~655.35ms 10us 0.2%+10us
Rising/Falling Time Resolution Accuracy	10us~655.35ms 10us 0.2%+10us	10us~655.35ms 10us 0.2%+10us
<b>List Characteristics</b>		
Step Time Resolution Accuracy	10us~100000s 10us 0.2%+10us	10us~100000s 10us 0.2%+10us
Number of Steps	1~50	1~50
Cycle	1~65535	1~65535
Store Capacity	7 lists	7 lists
Expanded Functions	Chain	Chain
<b>Battery Discharge</b>		
Discharge Time Resolution Accuracy	1s~100h 1s 0.2%+1s	1s~100h 1s 0.2%+1s
Battery Capacity Resolution Accuracy	1mAh~2000Ah 1mAh 0.3%+0.01Ah	1mAh~3000Ah 1mAh 0.3%+0.01Ah
<b>Short Circuit</b>		
CCL Mode	2. 2A	3. 3A
CCH Mode	22A	33A
CV Mode	0V	0V
CRL Mode	0. 06 Ω	0. 06 Ω
CRM Mode	6 Ω	6 Ω
CRH Mode	60 Ω	60 Ω
CPV Mode	220W	370W
CPC Mode	0W	0W
<b>Maximum Slew Rate</b>		
Current Voltage	2A/us 0.6V/us	3A/us 0.6V/us
<b>Programmable Open Circuit</b>	≥20kΩ	≥20kΩ
<b>Trigger Input</b>		
Trigger Level Trigger Pulse Width	TTL falling edge ≥10us	TTL falling edge ≥10us

<b>Maximum DC Input</b>		
Current	22A	33A
Voltage	210V	210V
<b>Protection Features</b>	OV, OC, OP, OT, RV	OV, OC, OP, OT, RV
<b>Reverse Current Capacity</b>		
Input OFF	25A	25A
Input ON	35A	40A
<b>Ripple and Noise</b>		
Current(rms/p-p)	3mA/30mA	3mA/30mA
Voltage(rms)	5mV	5mV
<b>Environmental Conditions</b>		
Temperature	0~50°C	0~50°C
Relative Humidity	≤85%	≤85%
<b>Remote Interface</b> <sup>*6</sup>	RS232, GPIB, USB	RS232, GPIB, USB
<b>Programming Language</b>	SCPI	SCPI
<b>AC Input</b>		
Voltage	AC110V or AC220V±15%	AC110V or AC220V±15%
Frequency	48 to 63Hz	48 to 63Hz
<b>Net Weight</b>	5.8kg	5.8kg

<b>Model</b>	3724A
<b>Input Ratings</b>	
Current	0~20A
Voltage	0~500V
Power <sup>*1</sup>	250W at 40°C
<b>Input Characteristics</b>	
Input Characteristics	
Minimum Operation Voltage @ Full Scale Current	2V
<b>Constant Current Mode</b>	
Low Range	0~2A
Resolution	0.1mA
Accuracy	0.1%+5mA

High Range Resolution Accuracy	0~20A 1mA 0.1%+10mA
<b>Constant Voltage Mode</b>	
Range Resolution Accuracy	0~500V 5mV 0.1%+62.5mV
<b>Constant Resistance Mode</b>	
Low Range Resolution Accuracy @I>2A	0.125~12.5Ω 0.1mΩ 0.5%+150mΩ
Middle Range Resolution Accuracy@V>50V	12.5~1250Ω 13.8uS 0.3%+1mS
High Range Resolution Accuracy@V>50V	125~12500Ω 1.54uS 0.3%+0.5mS
<b>Constant Power Mode</b>	
Range Resolution@P<100W @P≥100W Accuracy	0~250W 1mW 10mW 0.2%+600mW
<b>Current Measurement</b>	
Low Range Resolution Accuracy	0~2A 0.1mA 0.05%+4mA
High Range Resolution Accuracy	0~20A 1mA 0.05%+8mA
<b>Voltage Measurement</b>	
Range Resolution Accuracy	0~500V 1mV 0.1%+200mV
<b>Power Measurement</b>	
Range Resolution@P<100W @P≥100W Accuracy	0~250W 1mW 10mW 0.1%+600mW
<b>Current Slew Rate</b>	
Range CCH CCL <sup>*3</sup>	1mA/us~2A/us 100uA/us~200mA/us
Resolution	1mA/us

Accuracy*4	3% + 10us
<b>Transient Operation</b>	
Transient Mode	Continuous, Pulse, Toggled
Frequency Range*5	0.38Hz~50kHz
High/Low Time	0~655.35ms
Resolution	10us
Accuracy	0.2%+10us
Rising/Falling Time	10us~655.35ms
Resolution	10us
Accuracy	0.2%+10us
<b>List Operation</b>	
Step Time	10us~100000s
Resolution	10us
Accuracy	0.2%+10us
Number of Steps	1~50
Cycle	1~65535
Storage Capacity	7 lists
Expanded Functions	Chain
<b>Battery Discharge</b>	
Discharge Time	1s~100h
Resolution	1s
Accuracy	0.2%+1s
Battery Capacity	1mAh~2000Ah
Resolution	1mAh
Accuracy	0.3%+0.01Ah
<b>Short Circuit Operation</b>	
CCL Mode	2.2A
CCH Mode	22A
CV Mode	0V
CRL Mode	0.12Ω
CRM Mode	12Ω
CRH Mode	120Ω
CPV Mode	270W
CPC Mode	0W
<b>Maximum Slew Rate</b>	
Current	2A/us
Voltage	0.6V/us
<b>Open-circuit Resistance</b>	≥20kΩ
<b>Trigger Input</b>	
Trigger Level	TTL falling edge
Trigger Pulse Width	≥10us
<b>Maximum DC Input</b>	

Current	22A
Voltage	525V
<b>Protection Features</b>	OC, OV, OT, OP, RV
<b>Reverse Current Capacity</b>	
Input OFF	25A
Input ON	35A
<b>Ripple and Noise</b>	
Current(rms/p-p)	3mA/30mA
Voltage(rms)	30mV
<b>Environmental Conditions</b>	
Temperature	0~50°C
Relative Humidity	≤85%
<b>Remote Interface</b> <sup>*6</sup>	RS232, GPIB, USB
<b>Programming Language</b>	SCPI
<b>AC Input</b>	
Voltage	AC110V or AC220V±15%
Frequency	48 to 63Hz
<b>Net Weight</b>	5.8kg

- \*1. Maximum continuous power available is derated linearly from 100% of maximum at 40°C, to 75% of maximum at 50 °C.
- \*2. Conductance (S) = 1 / Resistance (Ω). The siemens is the SI derived unit of conductance, and the symbol is "S".
- \*3. The set level is 10 times larger than the slew rate in CCL mode.
- \*4. The actual transition time is defined as the time required for the input to change from 10% to 90% or from 90% to 10% of the programmed excursion.
- \*5. Transient frequency depends on the time for high/low level and rising/falling edge.
- \*6. Full remote control via RS232 with optional GPIB and USB.

