

TENMARS

UV-AB Meter TM-223 User's Manual

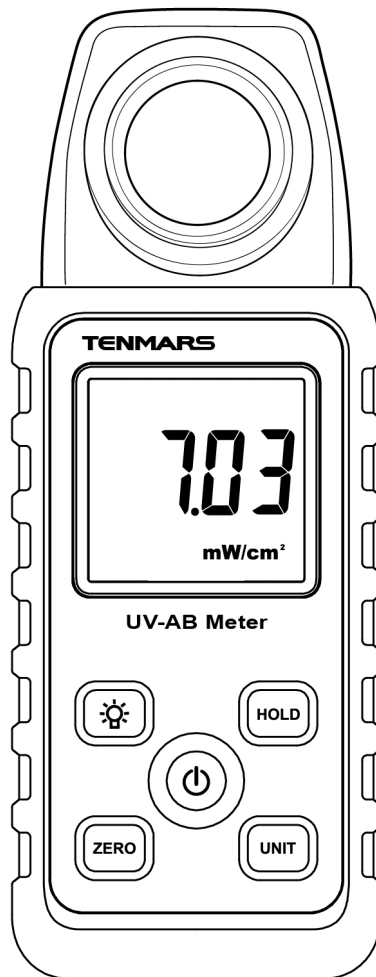

HB2TM2230000

CONTENTS

1.	FOREWORD	1
2.	FEATURES.....	1
3.	APPLICATIONS Industrial.....	1
4.	LABORATORY	2
5.	NAME AND FUNCTION OF EACH PART	2
5.1.	The lcd display shows.....	2
5.2.	Buttons:.....	2
6.	ELECTRIC SPECIFICATION SPECIFICATIONS	3
7.	TEST PROCEDURE.....	4
7.1.	Power button.....	4
7.2.	Zero“ BUTTON“	4
7.3.	Backlight Display and Reading in The Dark.	4
7.4.	UNIT button:	5
7.5.	Data hold button:	5
8.	SAFETY AND MAINTENANCE	6
9.	BATTERY REPLACEMENT	6
10.	SERVICE	7
11.	END OF LIFE.....	9

1. FOREWORD

Thank you for purchasing our product. Please, read the operating instructions in details before you use this UVAB optics meter, so you will operate the meter correctly. This meter can be used in industry and home.

2. FEATURES

- Professional , high quality UV meter.
- Ultra-violet irradiation measurement fo UV
- UV detector spec trim from 290 nm to 390 nm.
- Measurement range: 3999 $\mu\text{W}/\text{cm}^2$ and 39.99 W/cm^2
- Build Zero button.
- Microprocessor circuit provides high reliability and durability.
- Separate UV LIGHT probe allows user to measure the UV light at an optimum position.
- LCD display, easy readout.
- Overload display OL.
- Power off: Manual on/off by push button, or auto shut off after 15 minutes
- Measurement: There $1\mu\text{w}/\text{cm}^2$, $1.00\text{mW}/\text{cm}^2$.

3. APPLICATIONS INDUSTRIAL

- Monitoring blue light radiation hazards in welding.
- UV sterilization.
- Graphic arts.
- Photochemical matching.
- UV EPROM erasure.
- Photos resist exposure.
- Curing of inks, adhesives and coatings.
- Convenient, no need to adjust, data displayed clearly.

4. LABORATORY

- Weathering "degradation studies".
- UV sterilization.
- Virology.
- Microbial genetics.
- DNA research.
- Biologic hoods.
- General laboratory use.

5. NAME AND FUNCTION OF EACH PART

5.1. THE LCD DISPLAY SHOWS

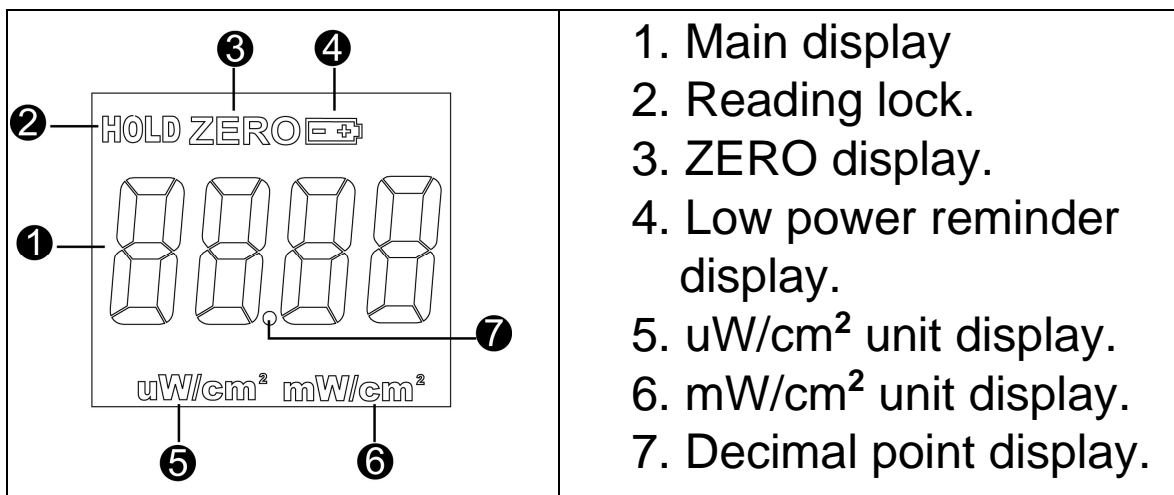

5.2. BUTTONS:

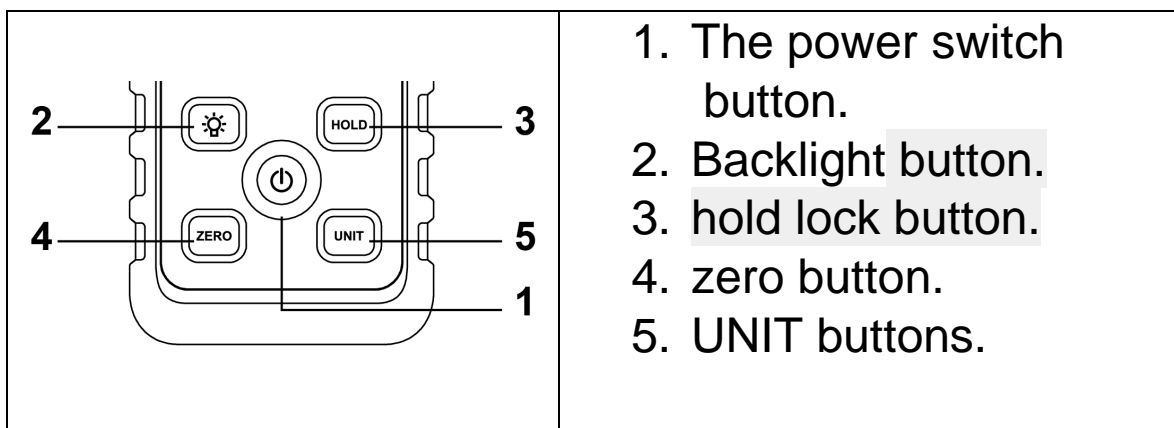

6. ELECTRIC SPECIFICATION SPECIFICATIONS



- DISPLAY : 3-3/4 digits LCD with maximum reading 4000.
- Range : $\mu\text{W}/\text{cm}^2$ 、 mW/cm^2 .
- Ranges and range: $3999 \mu\text{W}/\text{cm}^2 \sim 39.99\text{mW}/\text{cm}^2$ ($1000 \mu\text{W}/\text{cm}^2 = 1 \text{mW}/\text{cm}^2$).
- UV sensor spectrums Band pass: 290 nm to 390 nm.
- Accuracy : ($\pm 4\% \text{FS} + 2 \text{dgt}$) FS: full scale
15%:sunlight ultraviolet.
- Peak sensitivity wavelength : 365 nm.
- Sample Time Approx. 3 sec.
- Accuracy : $< \pm 3 / \text{year}$.
- Over-input : Display shows" OL".
- Operating : Temperature $5^\circ\text{C} \sim 40^\circ\text{C}$, below 80%RH.
- Storage temp. & RH : $-10^\circ\text{C} \sim 60^\circ\text{C}$, below 70%RH.
- Battery life : Approx.50 hr.
- Size Main instrument : 133 x 48 x 27 mm. approx 90g.
- EMC : this instrument is EMC-compliant and has undergone compatibility tests according to EN61326 (1997) + A1 (1998) + A2 (2001).

■ ACCESSORIES

- User manual.
- 2 batteries 1.5V AAA MN2400 LR03 AM4.
- Carrying case.

7. TEST PROCEDURE

7.1. POWER BUTTON

- Press the “” button to turn ON the power. The display comes alive.
- Press the “” button once again to turn OFF the power and put the device go into sleep mode. The display changes from light to dark.

7.2. ZERO“ BUTTON“

- Press the “” button for the zero adjustment if any digits are appearing.
- If performing the zero adjustment after powering on, several digits may not disappear. In this case, perform the zero adjustment again.



7.3. BACKLIGHT DISPLAY AND READING IN THE DARK.

- Press “” key backlight light on. Again Press“”



button to power off.

- Backlight light turns off automatically after 30 seconds.

7.4. UNIT BUTTON:

- Press the “” button to turn ON the power and put the device to operating mode. The screen displays 0000uW/cm². Press the “” button to switch from 0000uW/cm² to 00.00mW/cm². To select a different unit, just press this button once again.

7.5. DATA HOLD BUTTON:

- Press the “” button to go into hold mode, and “” appears on the screen to allow you to read the data. Press this button once again to deactivate it.

8. SAFETY AND MAINTENANCE

- Operating altitude: below 2,000m.
- Operating environment: for indoor and outdoor use, expose to pollution level II.
- This is a precision device. During use or storage, do not go beyond its spec. to prevent any possible damage or danger.
- Do not put this device in direct sunlight or where it is hot and/or damp.
- Remember to turn OFF the power after use. For long storage, remove the battery to prevent the battery from leaking to cause damage to the parts inside.
- Clean the device with a dry soft cloth. Wet cloths, liquid and water are prohibited.

9. BATTERY REPLACEMENT

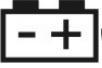
When the symbol " is displayed, batteries need replacement.

	CAUTION
	Before replacing batteries disconnect the test leads from any energized circuits to avoid electrical shocks.

- Turn OFF the meter and disconnect the test leads from the input terminals.
- Use of hand or screwdriver Unscrew the battery cover and remove the battery. Insert a new battery of the same type (2 batteries 1.5V AAA MN2400 LR03 AM4)
- Observing the proper polarity, re-screw the battery cover

and reposition the protective holster.

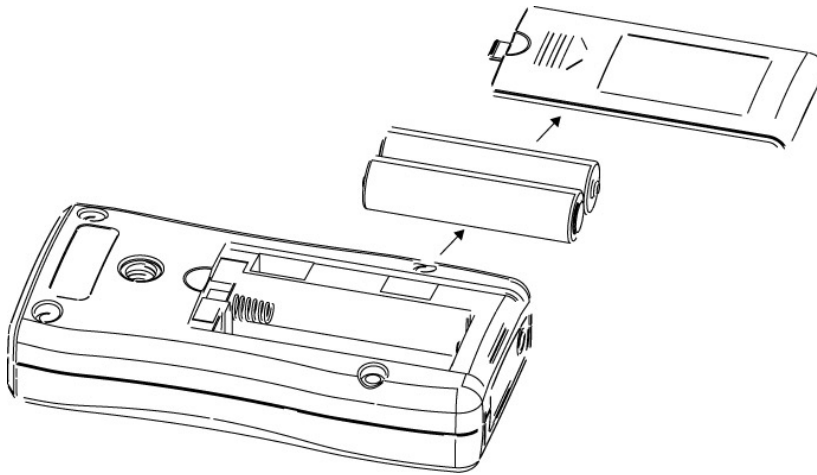

10. SERVICE

- Warranty Conditions.
- This instrument is guaranteed for one year against material or production defects, in accordance with our general sales conditions. During the warranty period the manufacturer reserves the right to decide either to repair or replace the product.
- Should you need for any reason to return back the instrument for repair or replacement take prior agreements with the local distributor from whom you bought it. Do not forget to enclose a report describing the reasons for returning (detected fault). Use only original packaging. Any damage occurred in transit due to non original packaging will be charged anyhow to the customer.
- The warranty doesn't apply to:
 - Accessories and batteries (not covered by warranty).
 - Repairs made necessary by improper use (including adaptation to particular applications not foreseen in the instructions manual) or improper combination with incompatible accessories or equipment.
 - Repairs made necessary by improper shipping material

causing damages in transit.

- Repairs made necessary by previous attempts for repair carried out by non skilled or unauthorized personnel.
- Instruments for whatever reason modified by the customer himself without explicit authorization of our Technical Dept.

The contents of this manual may not be reproduced in any form whatsoever without the manufacturer's authorization.

Our products are patented and our logotypes registered. We reserve the right to modify specifications and prices in view of technological improvements or developments which might be necessary.

■ Service

If the equipment is an exception, calling repair before you test the battery and test lines and other conditions, if necessary, replace it.

If the device still does not operate, check whether the operating procedures described in this manual consistent.

To equipment repair, you must return the service at the (local address or regional offices), the customer pays the freight must be obtained before sending the other party's consent.

Must be used to send the original packaging and included in the device more clearly as possible the content.

If you do not use the original packaging to send the sender will be responsible for damage caused.

Shouldn't the instrument work properly, before contacting your distributor make sure that batteries are correctly installed and working, check replace them if necessary

Should you need for any reason to return back the instrument for repair or replacement take prior agreements with the local distributor from whom you bought it. Do not

forget to enclose a report describing the reasons for returning (detected fault). Use only original packaging. Any damage occurred in transit due to non original packaging will be charged anyhow to the customer.

The manufacturer will not be responsible for any damage to persons or things.

11. END OF LIFE

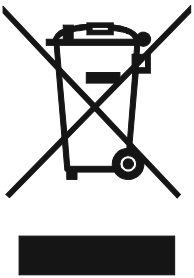

Caution: this symbol indicates that equipment and its accessories shall be subject to a separate collection and correct disposal

TENMARS ELECTRONICS CO., LTD

6F, 586, RUI GUANG ROAD, NEIHU,
TAIPEI 114, TAIWAN.

E-mail: service@tenmars.com

<http://www.tenmars.com>