

INSTRUCTION MANUAL

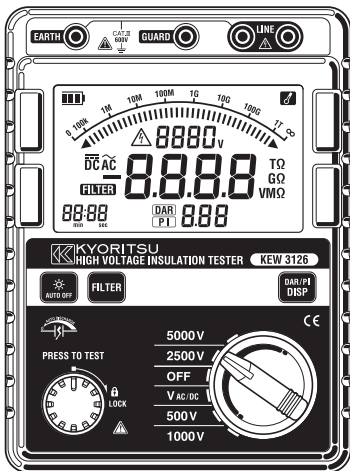

4-range High voltage insulation resistance tester

KEW 3126



**KYORITSU ELECTRICAL
INSTRUMENTS WORKS, LTD.**

Contents

1. Safety warnings	1
2. Feature	5
3. Specification	6
4. Instrument layout	
4-1 Instrument layout	9
4-2 LCD display	10
5. Preparation for measurement	
5-1 Checking the battery voltage	11
5-2 Connecting test leads	11
6. Measurement	
6-1 Mains disconnection check (Voltage measurement)	12
6-2 Insulation resistance measurement	13
6-3 Continuous measurement	16
6-4 DAR/PI measurement function	17
6-5 Voltage characteristics of measuring terminal	21
6-6 Use of Guard terminal	21
6-7 Filter function	22
6-8 Backlight function	22
6-9 Auto-power-off function	22
7. Battery replacement	23
8. Accessories	
8-1 Metal part for Line Probe, and replacement	24
8-2 How to use the adaptor for recorder	25
8-3 Line probe with alligator clip	25

1. Safety warnings



This instrument has been designed, manufactured and tested according to IEC 61010: Safety requirements for Electronic measuring apparatus, and delivered in the best condition after passed the inspection. This instruction manual contains warnings and safety rules which must be observed by the user to ensure safe operation of the instrument and retain it in safe condition.



Therefore, read through these operating instructions before using the instrument.

WARNING

- Read through and understand instructions contained in this manual before starting to use the instrument.
- Save and keep the manual at hand to enable quick reference whenever necessary.
- The instrument is to be used only in its intended applications.
- Understand and follow all safety instructions contained in the manual.

It is essential that the above instructions are adhered to. Failure to follow the above instructions may cause injury, instrument damage and/or damage to equipment under test.

The symbol  indicated on the instrument means that the user must refer to related parts in the manual for safe operation of the instrument. It is essential to read the instructions wherever the  symbol appears in the manual.

- | | |
|--|--|
|  DANGER | is reserved for conditions and actions that are likely to cause serious or fatal injury. |
|  WARNING | is reserved for conditions and actions that can cause serious or fatal injury. |
|  CAUTION | is reserved for conditions and actions that can cause injury or instrument damage. |

⚠ DANGER

- Never make measurement on the circuit in which electrical potential to ground over 600V exists.
- Do not attempt to make measurement in the presence of flammable gasses. Otherwise, the use of the instrument may cause sparking, which can lead to an explosion.
- Never attempt to use the instrument if its surface or your hand is wet.
- Be careful not to short-circuit the power line with the metal part of the test leads when measuring voltage. It may cause personal injury.
- Do not apply inputs exceeding the maximum allowable measuring range.
- Do not press the Test button with test leads connected to the instrument.
- Never open the battery compartment cover while making a measurement.
- Do not touch the circuit under test while measuring insulation resistance or right after a measurement. You may get an electric shock by a test voltage.







⚠ WARNING

- Never attempt to make any measurement if any abnormal conditions are noted, such as broken case and exposed metal parts or when inner jackets are seen through the nicked outer jacket.
- Do not rotate the Range switch with the test leads connected to the equipment under test.
- Do not install substitute parts or make any modification to the instrument. Return the instrument to your local Kyoritsu distributor for repair or re-calibration.
- Do not try to replace the batteries if the surface of the instrument is wet.
- Firmly insert the plug into the terminal when using test leads.
- Ensure that the instrument is powered off when opening the battery compartment cover for battery replacement.

CAUTION

- Always make sure to set the Range switch to the appropriate position before making a measurement.
- Set the Range Switch to “OFF” position after use and disconnect the test leads from the instrument. Remove the batteries if the instrument is to be stored and will not be used for a long period.
- Do not expose the instrument to the direct sun, high temperature and humidity or dewfall.
- Use a cloth dipped in alcohol for cleaning the test leads and the part around the measuring terminals.
- Do not store the instrument if it is wet.
- The Voltage warning mark is being displayed during a measurement and it flashes when voltages 30V(DC/AC) or more exist on the circuit under test.

Symbols

	Danger of possible electric shock
	Instrument with double or reinforced insulation
	DC
	AC
	Earth terminal
	Crossed-out wheel bin symbol (according to WEEE Directive: 2002/96/EC) indicating that this electrical product may not be treated as household waste, but that it must be collected and treated separately.

○ Measurement categories(Over-voltage categories)

To ensure safe operation of measuring instruments, IEC 61010 establishes safety standards for various electrical environments, categorized as CAT I to CAT IV, and called measurement categories.

Higher-numbered categories correspond to electrical environments with greater momentary energy, so a measuring instrument designed for CAT III environments can endure greater momentary energy than one designed for CATII.

- CAT I : Secondary electrical circuits connected to an AC electrical outlet through a transformer or similar device.
- CAT II : Primary electrical circuits of equipment connected to an AC electrical outlet by a power cord.
- CAT III : Primary electrical circuits of the equipment connected directly to the distribution panel, and feeders from the distribution panel to outlets.
- CAT IV : The circuit from the service drop to the service entrance, and to the power meter and primary overcurrent protection device (distribution panel).

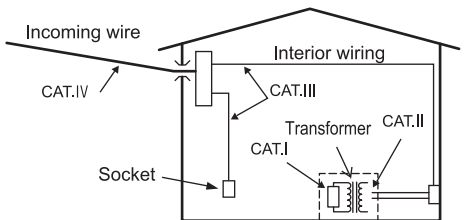

2. Feature

KEW3126 is a microcomputer controlled, high voltage insulation resistance tester with 4-range for measuring insulation resistance.

- Designed to following safety standards:
 - IEC 61010-1 (CAT.III 600V Pollution degree 2)
 - IEC 61010-031 (Requirements for hand-held probes)
- With auto-discharge function
When insulation resistance like a capacitive load is measured, electrical charges stored in capacitive circuits are automatically discharged after measuring. Discharge can be checked on the voltage monitor.
- Backlight function to facilitate working at dimly illuminated location or at nighttime work.
- Bar graph to display measured result
- LIVE circuit warning symbols plus audible warning
- With Auto-power off function
To prevent the instrument being left powered on and conserve battery power, the instrument automatically turns off approx. 10 min. after the last switch operation.
- Auto-measurement and display of DAR (Dielectric Absorption Ratio) and PI (Polarization Index)
- Filter function to reduce the variations in readings due to external influences
- With a short current of max 5mA, quick measurement is possible even if the object under test has capacitive components.

3. Specification

- Applicable standards

IEC 61010-1 Measurement CAT.III 600V Pollution degree2

IEC 61010-031 Standard for hand-held probes

MODEL7165A(CAT.III 600V)

MODEL7224A(CAT.IV 600V)

MODEL7225A(CAT.IV 600V)

* When KEW3126 and the test lead are combined and used together, whichever is lower category either of them belong to is applied.

IEC 61326-2-2 EMC standard

IEC 60529 IP40

- Measuring range and accuracy

(Temperature, humidity: 23±5C°, 45 — 75%RH)

<Insulation resistance tester>

Rated voltage	500V	1000V	2500V	5000V
Measuring Range	0.0 — 99.9MΩ 100 — 999MΩ	0.0 — 99.9MΩ 100 — 999MΩ 1.00 — 1.99GΩ	0.0 — 99.9MΩ 100 — 999MΩ 1.00 — 9.99GΩ 10.0 — 99.9GΩ	0.0 — 99.9MΩ 100 — 999MΩ 1.00 — 9.99GΩ 10.0 — 99.9GΩ 100 — 1000GΩ
Open circuit Voltage	DC 500V +30%, -0%	DC 1000V +20%, -0%	DC 2500V +20%, -0%	DC 5000V +20%, -0%
Rated Current	1mA or more, 1.2mA or less (at 0.5MΩ load)	1mA or more, 1.2mA or less (at 1MΩ load)	1mA or more, 1.2mA or less (at 2.5MΩ load)	1mA or more, 1.2mA or less (at 5MΩ load)
Short-circuit current	For 10 sec after a test is started : max 5mA, after that : 1.4mA			
Accuracy	±5%rdg±3dgt			100GΩ or more, ±20%rdg

Voltage monitor for insulation resistance range

30 — 6000V (resolution 10V): ±10%rdg±20V

This monitor is used to check whether electrical charge stored on the equipment under test is discharged or not. The measured voltage value displayed on the LCD is a reference value.

Please be noted that the indicated value, when external AC voltage is applied to the instrument, is not the correct value.

<Voltmeter>

	DC voltage	AC voltage
Measuring range	±30 — ±600V	30 — 600V(50/60Hz)
Resolution	1V	
Accuracy	±2%rdg±3dgt	

- Display: Liquid crystal display
Insulation resistance range: Max.999 counts (1000 counts only at 1TΩ display)
V range: Max. 630 counts
Bar graph : Max. 36 points
DAR/PI value : 9.99
Time: 60:00
- Low battery warning: Battery mark display (in 4 levels)
- Overrange indication: “OL” mark appears at insulation resistance range and “Hi” mark at voltage range.
- Auto-ranging: Range shifts to upper range : 1000 counts
Range shifts to lower range : 80 counts
(Only at the insulation resistance range)
- Auto-power-off: Power off function operates in 10 min. after the last switch operation.
- Used location: altitude 2000 m or less
- Temperature & humidity range (guaranteed accuracy):
23°C±5°C/Relative humidity 85% or less
(no condensation)
- Operating temperature & humidity range:
0°C to 40°C/Relative humidity 85% or less
(no condensation)
- Storage temperature & humidity range:
-20°C to +60°C/Relative humidity 75% or less
(no condensation)

- Overload protection: Insulation resistance range: AC1200V/10sec.
Voltage range: AC720V/10sec.
- Withstand voltage: AC5320V(50/60Hz)/5sec.
(Between electrical circuit and enclosure)
- Insulation resistance: 1000MΩ or more/DC1000V
(Between electrical circuit and enclosure)
- Dimension: 205(L)×152(W)×94(D)mm
- Weight: approx. 1.8kg (battery included)
- Power source: DC12V: Alkaline battery size C(LR14)x 8pcs
- Current consumption (representative values at 12V of supply voltage)

Range	500V	1000V	2500V	5000V	V _{AC/DC}
Output at short-circuit	For 10 sec after a test is started : 850mA, after that : 150mA				110mA * at voltage measurement
When rated measuring current is outputted	450mA /0.5MΩ	500mA /1MΩ	600mA /2.5MΩ	850mA /5MΩ	
Output at open circuit	45mA	50mA	70mA	110mA	
On stand-by	25mA				110mA
When backlight is on	Increased by 30mA				

Note) Current values in above table are all approximate values.

- Operating time: approx. 10 hours continuous
- under a load of 100MΩ at 5000V Insulation resistance range
- Accessories: Line probe: MODEL7165A
Earth cord: MODEL7224A
Guard cord: MODEL7225A
Alkaline size C battery (LR14) x 8pcs
Instruction manual
Hard Case MODEL9159
Pickel Type Prod: MODEL8019
Straight Type Prod: MODEL8254
- Optional accessories: Adaptor for recorder MODEL8302
Line probe with alligator clip MODEL7168

4. Instrument layout

4-1 Instrument layout

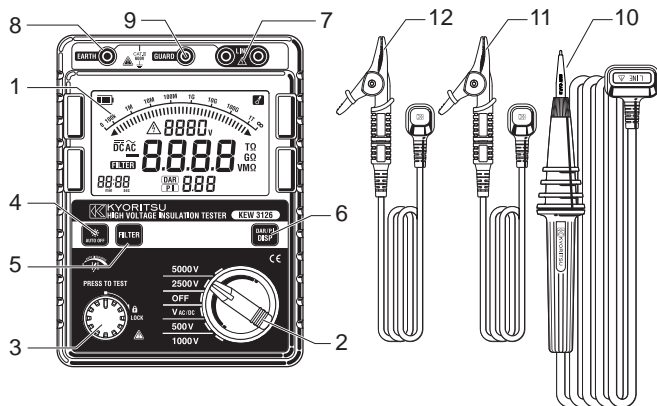

- 1 LCD display
- 2 Range switch
- 3 Test button
- 4 Back Light button
- 5 FILTER button
- 6 DAR/ PI DISP button
- 7 Line Terminal
- 8 Earth Terminal
- 9 Guard Terminal
- 10 Line Probe (red)
- 11 Earth Cord (black)
- 12 Guard Cord (green)

4-2 LCD display

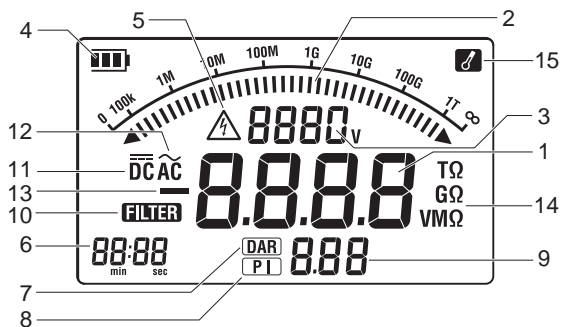

- 1 Insulation resistance
- 2 Bar graph
- 3 Voltage
- 4 Battery mark
- 5 Voltage warning mark
- 6 Time
- 7 DAR mark
- 8 PI mark
- 9 DAR/PI value
- 10 Filter mark
- 11 DC
- 12 AC
- 13 Minus sign
- 14 Unit
- 15 Overheat warning mark

5. Preparation for measurement

5-1 Checking the battery voltage

- (1) Set the Range switch to any position other than “OFF”.
- (2) When the battery mark shown at the upper left on the LCD is last 1 level  , the batteries are almost exhausted.

Replace the batteries with new ones to continue further measurements.

The instrument operates properly even in such a low battery power condition and it may not affect the accuracy.

When battery mark is empty  , the battery voltage is below the lower limit of the operating voltage. In such a condition, the accuracy isn't guaranteed.

Look up Chapter 7. Battery Replacement in this manual, which describes how to replace the batteries.

5-2 Connecting test leads

Insert the test lead firmly to the connector terminal on the instrument. Connect the Line Probe(red) to the Line terminal, the Earth Cord(black) to the Earth terminal and the Guard Cord (green) to the Guard terminal. (To establish guard is not necessary, you do not have to connect the Guard cord.)

 **DANGER**

- Do not press the Test button while the Range switch is at the Insulation measurement position. High voltages are applied to the test leads and you may get electrical shocks.

6. Measurement

6-1 Mains disconnection check (Voltage measurement)

⚠ DANGER

- Do not make measurement on a circuit in which the electric potential exceeds AC/DC600V (voltage to ground) in order to avoid getting electrical shock. In addition, do not use this instrument when the voltage to ground is 600V or higher even the line voltage is 600V or less.
- Ensure that a measurement is performed at the secondary side of the circuit breaker when testing the voltages of power lines, which has a large current capacity, in order to avoid possible hazard to the user.
- Extra precaution shall be taken to minimize the possibility of shorting the power line with the metal tip of test lead at voltage measurement. It may cause personal injury.
- Do not start a measurement with the battery cover removed.
- Connect the Earth cord (black) to the Earth terminal of the circuit under test.

Voltage can be measured by setting the Range switch on this instrument to “V_{AC/DC}” position. No need to press the Test button. KEW3126 has an AC/DC auto-detect circuit and can measure DC voltage as well. At DC voltage measurement, when applying positive voltage to the Line Probe (red), positive value is displayed on the LCD.

Ensure that the circuit breaker of the circuit under test is turned off.

- (1) Connect the Earth Cord (black) to the earth side of the circuit under test and the Line Probe (red) to the line side respectively.
- (2) Confirm that the voltage displayed on the LCD is “Lo”. If the display doesn’t show “Lo”, voltage is applied on the circuit under test. Check the circuit under test again and turn off the circuit breaker.

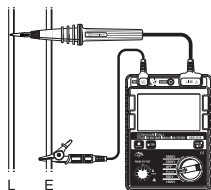

6-2 Insulation resistance measurement

DANGER

- Confirm that no electrical charge exists on the circuit under test before measuring by using a high voltage detector.
- Put on a pair of insulated gloves for high voltage.
- In case the Range switch is set to Insulation resistance range, high voltage is being applied to the tips of test leads and to the circuit under test continuously while the Test button is kept pressed down. Be extremely careful not to get electric shock.
- Do not start measurement with the battery cover removed.
- Never start measurement when thunder rumbling.
- Connect the Earth Cord (black) to the earth terminal of the circuit under test.
- With the Range switch set to the Insulation resistance range, live circuit warning symbol appears on the LCD and the audible warning activates when a voltage of 30V or higher is measured. KEW3126 doesn't start a test, even the Test button is pressed down, if the measuring voltage is 160V or higher: it starts a test if the measuring voltage is under 160V upon a press of the Test button. Prior to testing, ensure that the equipment under test is disconnected from the mains supply and not energized in order to avoid possible electrical hazards.

This instrument may start a measurement for energized electrical circuits. Be extremely careful not to get electrical shock.

To check the insulation of electric equipments or electric circuits, measure their insulation resistances by using this instrument.

Ensure to check the appropriate voltages to be applied to the equipment under test before starting a measurement.

Note)

- KEW3126 may show unstable readings when the insulation resistance of the equipment under test is not stable.
- Beep sound may be heard during insulation resistance measurement. But it is not malfunction.
- It takes time to measure a capacitive load.
- At insulation resistance measurement, positive (+) voltage is outputted from the Earth terminal and negative (-) voltage is outputted from the Line terminal.

Connect the Earth cord to the Earth (ground) terminal.

It is recommended to connect the positive(+) pole to the earth side when measuring insulation resistance against the ground or when a part of the equipment under test is earthed.

With this connection, smaller measured value can be obtained comparing with other way round.

- (1) Check the appropriate voltages to be applied to the circuit under test, and set the Range switch to any desired insulation resistance range.
- (2) Connect the Earth cord (black) to the Earth terminal of the circuit under test.
- (3) Put the tip of the Line probe (red) to the circuit under test. Then press the Test button. The buzzer sounds intermittently during measurement when a range other than 500V is selected.
- (4) The measured value will be displayed on the LCD, and it remains displayed on the LCD after a measurement.

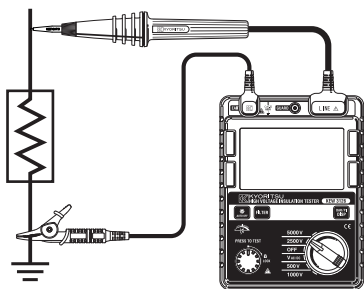

⚠ CAUTION
Turn off the breaker of the circuit under test.

- (5) This instrument has Auto-discharge function. Keep the test leads connected to the circuit under test and release the Test button when measurements end. The auto-discharge function operates to discharge the electrical charges on the circuit under test. Confirm that the voltage monitor shows 0V.

⚠ DANGER



- Do not touch the circuit under test immediately after testing. Capacitance stored in the circuit may cause electric shock.
- Leave test leads connected to the circuit and never touch the circuit until the discharge completes.

Auto-discharge function

This is a function to discharge capacitance stored in the circuit under test automatically after testing. Discharge condition can be checked on the voltage monitor. This function will be canceled when removing the test leads 2 sec. or more before discharge completes.

(6) Set the Range switch to “OFF” position, and remove test leads from the instrument.

Note)

- The voltage warning mark stays on during a measurement and it blinks when voltages of AC/DC 30V or higher exist on the circuit under test.
- When measuring low resistances (if currents larger than the rated current are output) over a long period of time, KEW3126 consumes large power and will overheat. When this happens, further tests are automatically inhibited and the over-temperature symbol  appears on the display. The instrument must then be left cool down. Testing shall be resumed when  symbol disappears.

Short-circuit currents at a start of measurement may get lower when the “” symbol appears.

- Depending on the ambient temperature or measured resistances, the “” symbol may appear and interrupt a PI measurement.

Principle of Insulation Resistance Measurement

Resistance value can be obtained by applying a certain high voltage to the resistance (insulation resistance) and measuring the flowing current.

$$\text{Resistance value} = \text{Voltage} / \text{Current} \\ (RX = V / I)$$

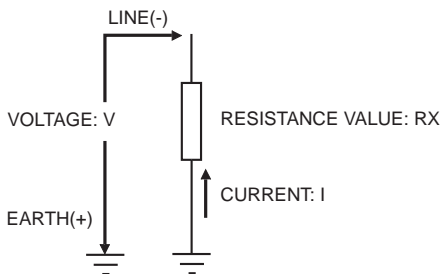

6-3 Continuous measurement

Press down and turn the Test button clockwise to lock it to perform a continuous measurement of insulation resistance. After testing, turn the button counterclockwise and set it to the initial position.

⚠ DANGER

- Be extremely careful not to get electric shock as high voltage is present on the tip of test leads continuously.

6-4 DAR/PI Measurement function

1. PI – Polarization index

This is to check a temporal increase of leakage currents flowing on insulations and to confirm leakage currents aren't increased as time passes.

PI is usually determined by the insulation resistances measured 1 min and 10 min after a measurement is started. PI is dependent on the shape of insulations and influenced by moisture absorption, therefore, a check of PI is important to diagnosis the insulation of cables.

$$PI = \frac{\text{Insulation resistance (10 min after a start of test)}}{\text{Insulation resistance (1 min after a start of test)}}$$

PI	4 or more	4 – 2	2.0 – 1.0	1.0 or less
Criteria	Best	Good	Warning	Bad

2. DAR - Dielectric Absorption Ratio

DAR measurement is almost same to PI measurement in a sense that they test the time course of insulation. The only difference is that DAR measurement can get result faster than the other.

$$DAR = \frac{\text{Insulation resistance (1 min after a start of test)}}{\text{Insulation resistance (15 or 30 sec min after a start of test)}^*1}$$

DAR	1.4 or more	1.25 – 1.0	1.0 or less
Criteria	Best	Good	Bad

Note1: DAR time is selectable: 15 or 30 sec.

How to select:

- (1) Keep the DISP button pressed down and rotate the Range switch to power on KEW3126. (DAR mark blinks on the LCD.)
- (2) Press the DISP button to switch 15 sec and 30 sec displayed at the lower left on the LCD. Select the desirable one.

- (3) Press the FILTER button and confirm the selection.
Selected DAR time is saved and kept after the instrument is powered off.
To check the time currently selected, follow the step (1) described as above.

3. How to measure DAR/ PI

DAR and PI are measured automatically at normal continuous measurement of insulation resistances. Set the Range switch to any range and measure the test object continuously.

- 1 min after a start of continuous measurement:
LCD shows DAR value.
- 10 min after a start of continuous measurement:
LCD shows PI value.

When DAR/PI values are displayed as “no”:

DAR and PI values are determined by the methods 1. and 2. as described above, therefore, they are displayed as “no” when the measured insulation resistances fall under any of following cases.

(1) measured value is “0.0MΩ”

(2) measured value is “OL”

* “OL” is displayed when the measured value exceeds the upper limit of the measuring range at each insulation resistance range.

Range	Upper limit
500V	999MΩ
1000V	1.99GΩ
2500V	99.9GΩ
5000V	1000GΩ

4. How DAR/ PI values are displayed

LCD shows DAR/PI values as shown below during measurements.

(1) Start of test



No DAR/PI value,
“---” is displayed.

(2) 1 min after the start of test

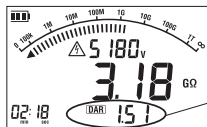

DAR value is displayed.

(3) 10 min after the start of test



PI value is displayed.
Press the DISP button to
switch DAR and PI values.

5. How to review the measured DAR/PI values

Press the DISP button when measurements end. The measured results are then displayed in following sequence. If the measurement ends earlier than the intervals described in below (2), (3) or (4), blank displays aren't shown and returns to (1).

(1) End of test

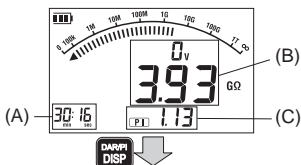

(A)	Time when a test ends
(B)	Value measured at the end of test (resistance value)
(C)	DAR or PI value (whichever was displayed at the end of test)

(2) Results at 15 or 30 sec after a start of test

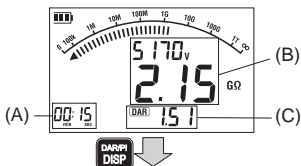

(A)	Elapsed time (15 or 30 sec)
(B)	Value measured 15 sec after a start of test. (resistance value, output voltage)
(C)	DAR value

(3) Results at 1 min after a start of test

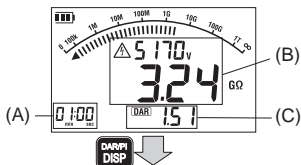

(A)	Elapsed time (1 min)
(B)	Value measured 1 min after a start of test. (resistance value, output voltage)
(C)	DAR value

(4) Results at 10 min after a start of test

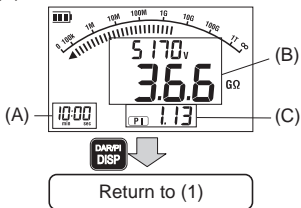

(A)	Elapsed time (10 min)
(B)	Value measured 10 min after a start of test. (resistance value, output voltage)
(C)	PI value

6-5 Voltage characteristics of measuring terminal

KEW3126 Output characteristics

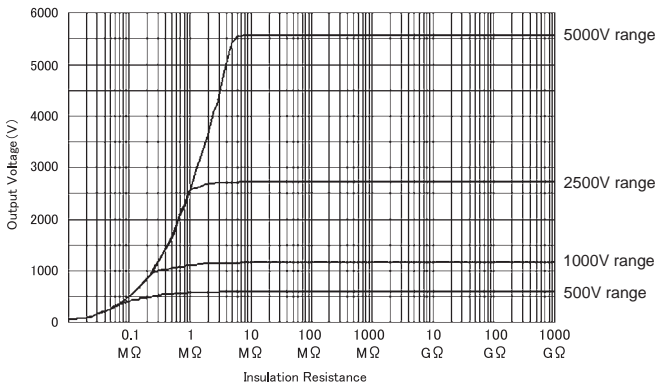

* for 10sec after a start of test

6-6 Use of Guard terminal

When measuring the insulation resistance of a cable, leakage current flowing on the surface of cable jacket and the current flowing inside the insulator are mixed and may cause error in insulation resistance value. In order to prevent such error, wind a conductive wire around the point where leakage current flows.

Then connect it to the Guard terminal as shown in the figure on the next page.

This is to move out the surface leakage resistance of the cable insulation to measure only the volume resistance of insulator.

Make sure to use the Guard cord supplied with this instrument to connect the instrument to Guard terminal.

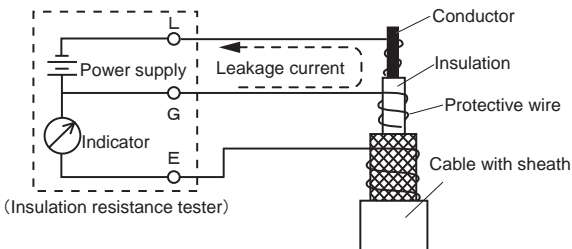

6-7 Filter function

KEW3126 has Filter function. Filter Mode is effective to reduce the variations in readings due to external influences during high resistance measurements. The filter type is Low pass filter with cut off frequency of 0.3Hz.

Press the FILTER button to enable the Filter function. The Filter mark then appears on the LCD. To check sudden variations in resistances, ensure that the Filter mode is turned off.

6-8 Backlight function

This function to facilitate working at dimly illuminated location or at nighttime work. The backlight doesn't work when the Range switch is set to "OFF". It automatically turns off 2 min after the last key operation; this feature is disabled while a measurement is processed.

6-9 Auto-power-off function

The instrument automatically turns off approx. 10 min. after the last switch operation. To restore from the auto power off status, set the Range switch to OFF position once and then set it to any desirable range.

7. Battery replacement

⚠ DANGER

- Never open the battery compartment cover while making measurement.

⚠ WARNING

- To avoid getting possible electric shock, remove test leads before opening the battery compartment cover. After replacing batteries, make sure to tighten up the screw for battery compartment cover.

⚠ CAUTION

- Do not mix new and old batteries nor different types of batteries.
- Make sure to install batteries in correct polarity as marked inside.
- After replacing batteries, confirm that the batteries are properly installed in the compartment and well-contacted with each battery contact spring. Improperly installed batteries may cause a battery liquid leak.

- (1) Set the Range switch to "OFF" position, and remove the test leads from the instrument.
- (2) Loosen the battery compartment cover fixing screws, and remove the battery compartment cover. Always replace all 8 batteries with new ones at the same time.
- (3) After replacing batteries, make sure to tighten up the screw for battery compartment cover.

Make sure to install batteries in correct polarity as marked inside.

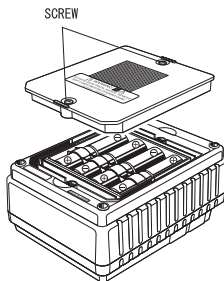

8. Accessories

8-1 Metal parts for Line Probe, and replacement

⚠ DANGER

In the electrical environment of CAT.II or higher, MODEL8252 should be attached and used with the test lead. With the large exposed metal parts of MODEL8254 and 8019, the equipment under test may be shorted. It may result in failure of the equipment under test and cause fire or lead to fatal or serious injury.

(1) Tip metal parts

MODEL8252: Standard Prod (straight type, with molded parts)

MODEL8254: Straight Type Prod

MODEL8019: Pickel Type Prod

To be used to hook the instrument.

(2) How to replace it

Turn the Line probe counterclockwise to remove the attached tip metal. Put the tip metal you want to use to the hexagon socket and turn it to clockwise together with the tip of probe, and tight up screws.

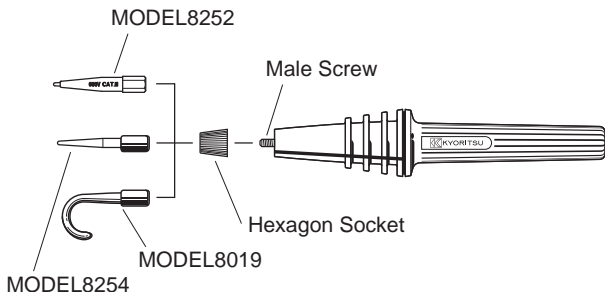

8-2 How to use the adaptor for recorder

MODEL8302 is the adaptor for recorder (option) for output current measurement. Connect it as shown in the below figure. Output is DC1mA when current of $1\mu\text{A}$ is flowing.

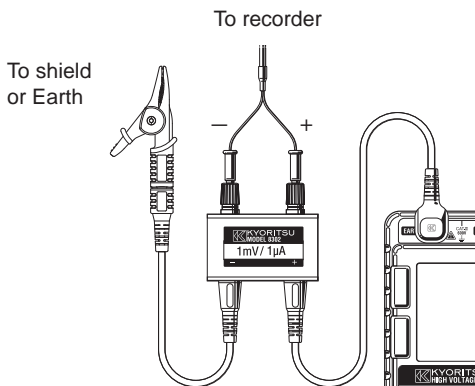

* MODEL8302 can measure currents up to 2mA.

8-3 Line probe with alligator clip

MODEL7168 Line probe with alligator clip
(optional accessory)

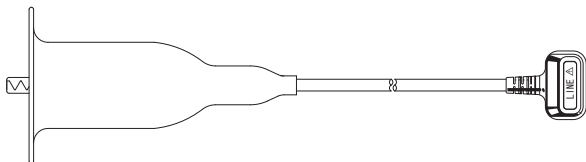

DISTRIBUTOR

Kyoritsu reserves the rights to change specifications or designs described in this manual without notice and without obligations.



**KYORITSU ELECTRICAL
INSTRUMENTS
WORKS, LTD.**

No.5-20,Nakane 2-chome, Meguro-ku,
Tokyo, 152-0031 Japan

Phone: +81-3-3723-0131

Fax: +81-3-3723-0152

URL: <http://www.kew-ltd.co.jp>

E-mail: info@kew-ltd.co.jp

Factory: Ehime