

USER'S MANUAL

BM2807CSE
BM2805CSE
BM2803CSE

Enhanced
Practical
Multimeter
Series



0) BRIEF INTRODUCTION

This 2800 CSE meter series is a safety Category and EMI Shielding Enhanced (CSE) version of our popular 800 practical meter series. Apart from the added up-to-date features and improvements in safety ratings, it is also equipped with EMI shielding on both sides of the circuitry module to improve measurement stability under harsh electromagnetic interferences, especially in the electrical and automotive industries.

1) SAFETY











This manual contains information and warnings that must be followed for operating the meter safely and maintaining the meter in a safe operating condition. If the meter is used in a manner not specified by the manufacturer, the protection provided by the meter may be impaired.

Observe proper safety precautions when working with voltages above 30 Vrms, 42.4 Vpeak, or 60 VDC. These voltage levels pose a potential shock hazard to the user. Disconnect the test leads from the test points before changing functions. Do not expose this product to rain or moisture. The meter is intended only for indoor use.

Keep your hands/fingers behind the hand/finger barriers (of the meter and the test probe assembly, where applicable) that indicate the limits of safe access of the hand-held parts during measurements. Inspect lead wires, connectors, and probes for damaged insulation or exposed metal periodically. If any defects are found, replace them immediately. Only use the test probe assembly provided with the meter or a UL Listed test probe assembly to the same meter ratings or better. Optional offer premium test probe assembly using silicone lead wire insulation, at agent's discretion, is equipped with white inner insulation layers as wear indicators. Replace them immediately if any of the white layers has become visible.

The meter meets IEC/EN/BSEN/CSA_C22.2_No./UL standards of 61010-1 Ed. 3.1 and 61010-2-033 Ed. 2.0 to Measurement Categories CAT III 1000V and CAT IV 600V. The accompanied test probe assembly meets IEC/EN/BSEN/CSA_C22.2_No./UL standards of 61010-031 Ed. 2.0 to the same meter ratings or better. The 61010-031 requires exposed conductive test probe tips to be $\leq 4\text{mm}$ for CAT III & CAT IV ($\leq 19\text{mm}$ for CAT II) ratings. The accompanied add-on caps (or permanent insulated tips option) have to be used for applications under CAT III & CAT IV. Refer to the category markings on your probe assemblies as well as on the add-on accessories (like detachable Caps or Alligator Clips), if any, for applicable rating changes.

INTERNATIONAL SYMBOLS

	Marking of Electrical and Electronic Equipment (EEE). Do not dispose of this product as unsorted municipal waste. Contact a qualified recycler
	Refer to the explanation in this Manual
	Possibility of electric shock
	Earth (Ground)
	Meter protected throughout by Double Insulation or Reinforced insulation
	Fuse
	Direct Current (DC)
	Alternating Current (AC)
	Three-phase Alternating Current
	Application of current sensor to and removal from Hazardous Live Uninsulated Conductors is permitted

BRIEF INFORMATION ON MEASUREMENT CATEGORIES

Measurement Category IV is applicable to test and measuring circuits connected at the source of the building's low-voltage MAINS installation. Examples are measurements on devices installed before the main fuse or circuit breaker in the building installation.

Measurement Category III is applicable to test and measuring circuits connected to the distribution part of the building's low-voltage MAINS installation. Examples are measurements on distribution boards (including secondary electricity meters), photovoltaic panels, wiring and stationary motors in the fixed installation, and equipment for industrial use.

Measurement Category II is applicable to test and measuring circuits connected directly to utilization points (socket outlets and similar points) of the low-voltage MAINS installation. Examples are measurements on MAINS CIRCUITS of household appliances, portable TOOLS and similar equipment, and on the consumer side only of socket-outlets in the fixed installation.

2) EUROPEAN DIRECTIVES AND UK STATUTORY REQUIREMENTS

The instruments conform to EUROPEAN (CE) Low-Voltage Directive 2014/35/EU, Electromagnetic Compatibility Directive 2014/30/EU, and RoHS 2 Directive 2011/65/EU plus amendment Directive (EU) 2015/863. The instruments also conform to the UK (UKCA) Electrical Equipment (Safety) Regulations 2016, Electromagnetic Compatibility Regulations 2016, and The Restriction of the Use of Certain Hazardous Substances in Electrical and Electronic Equipment Regulations 2012.

3) PRODUCT DESCRIPTION

This user's manual uses only representative model(s) for illustrations. Please refer to detailed specifications for function availability to a particular model.

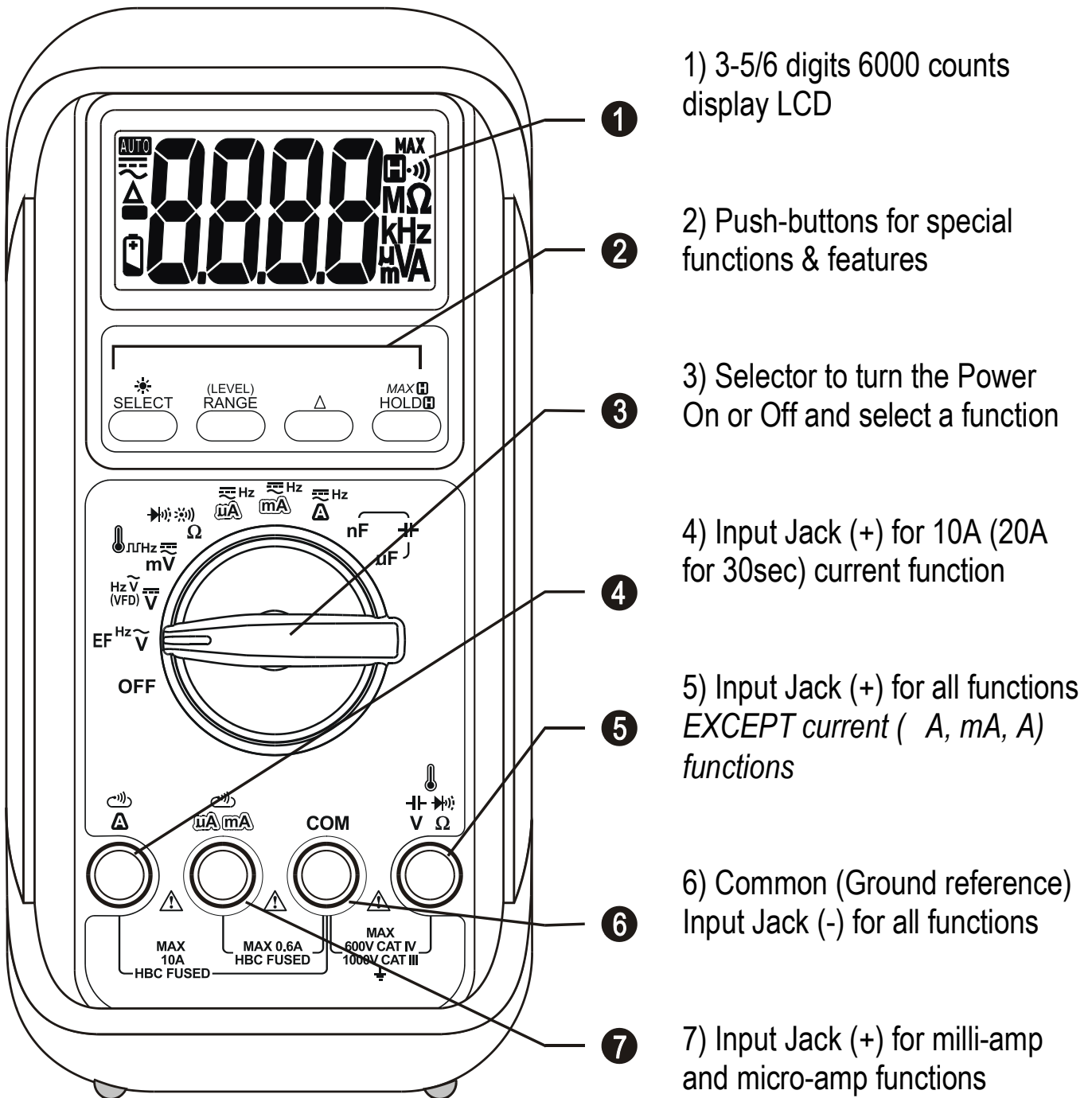

4) OPERATION

Note: Before and after hazardous voltage measurements, test the voltage function on a known source such as line voltage to determine proper meter functioning

ACV; Line-level Hz (Models 2807 & 2805 only)

Inputs are made via the terminals **COM/V**. Startup defaults to **ACV** Function. Press the **SELECT** button momentarily to select the **Line-level Hz** function.

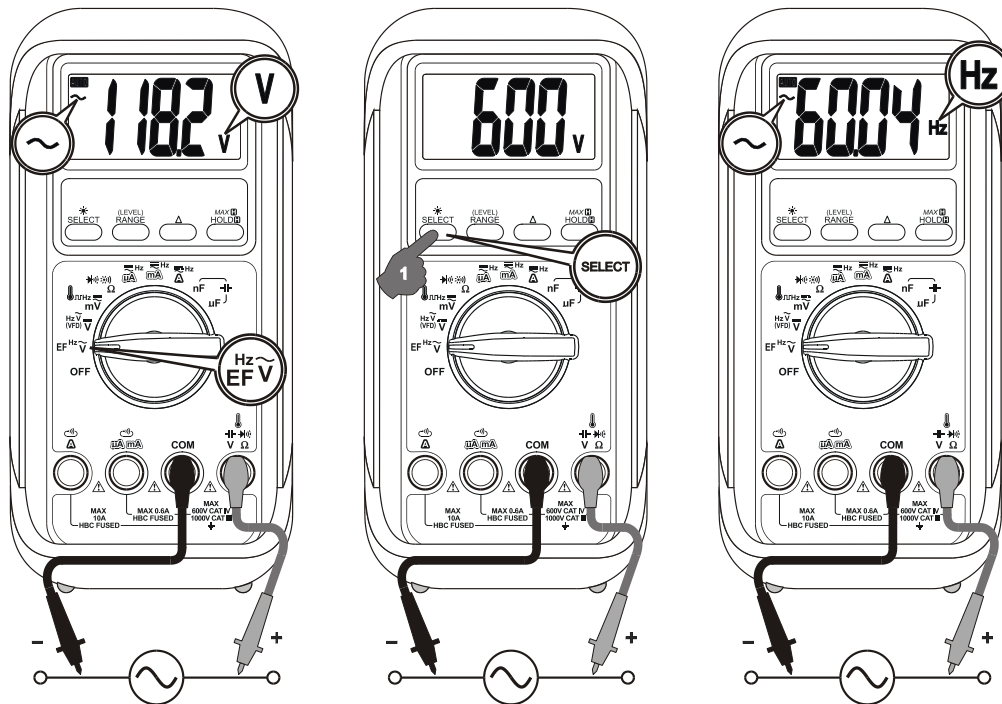

Note: Input sensitivity varies automatically with the function range selected while activating the Hz function. 6V function range has the highest and the 1000V range has the lowest. When activated, the trigger voltage range will be displayed right before the Hz readings start. Press momentarily the **RANGE** button can manually select another trigger voltage range. It is recommended to first measure the signal voltage level and activate the Hz function in that range to get the most appropriate trigger level. If the Hz reading becomes unstable, select lower sensitivity to avoid electrical noise. If the reading shows zero, select higher sensitivity.

EF-Detection of Electric Field (Model 2807 only)

Startup defaults to **ACV** Function. Press the **SELECT** button momentarily twice to select the **EF-Detection** function. The meter displays “EF-H”, the High sensitivity, when it is ready. If it is too sensitive for your applications, press the **(LEVEL)** button momentarily to toggle to **EF-L**, the Low sensitivity. The detected Electric Field is indicated as a series of display bar-segments, backlight flashing, and beep sounds in proportion to the field strength.

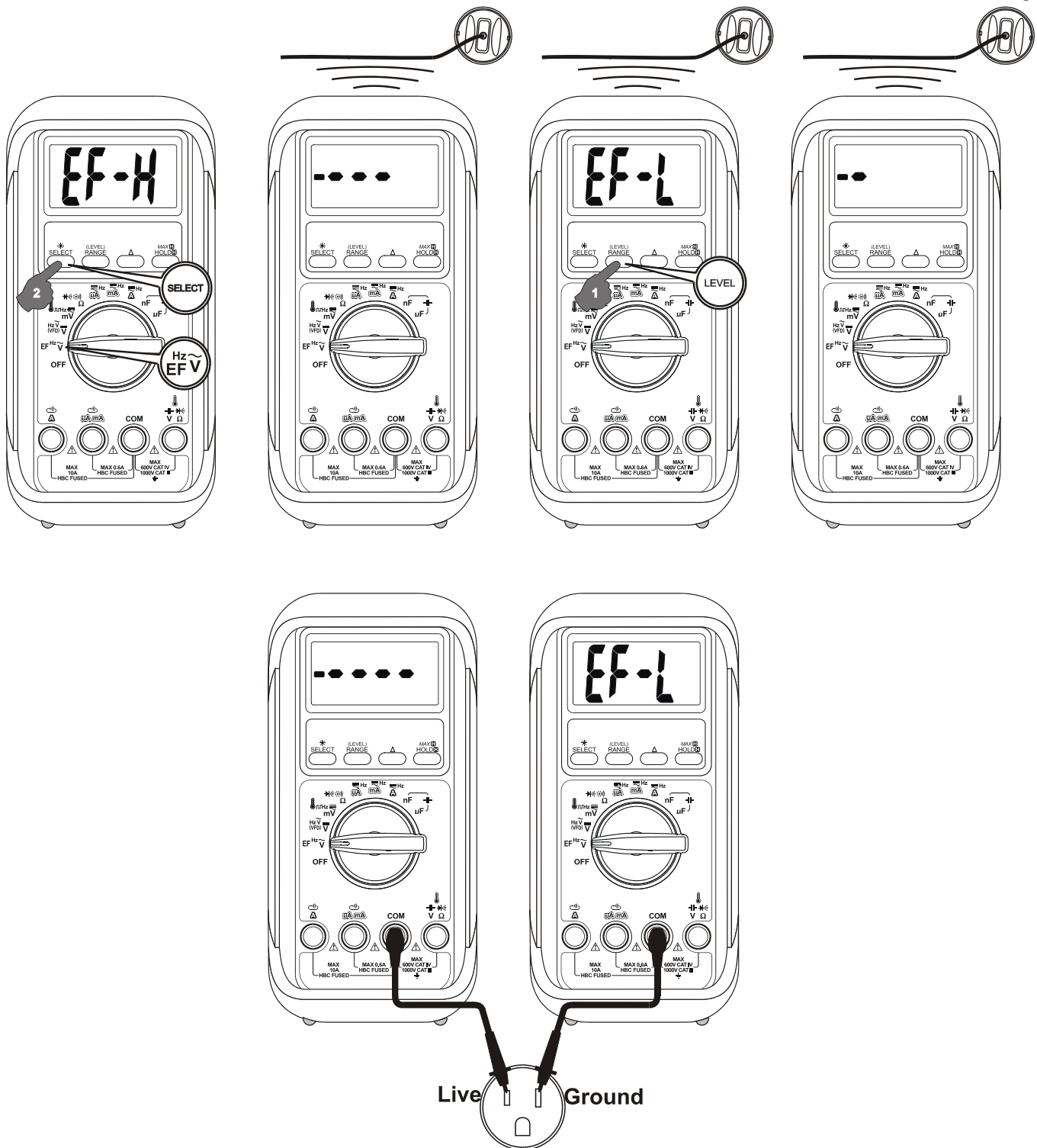

● **Non-Contact EF-Detection (NCV):** An antenna is located near the top end center of the meter, which detects the ac electric field surrounding energized conductors. It is ideal for tracing live wiring connections, locating wiring breakages, and distinguishing between live and earth connections.

● **Probe-Contact EF-Detection (Single-pole):** For more precise indications of live

wires, such as distinguishing between Live and Ground connections, use one single test probe to test via terminal **COM** for direct metal contact-probing to achieve the most distinctive indications.

DCV; VFD-ACV & Line-level VFD-Hz (Models 2807 & 2805 only)

Inputs are made via the terminals **COM/V**. Startup defaults to **DCV** Function. Press the **SELECT** button momentarily to select the subject functions in sequence.

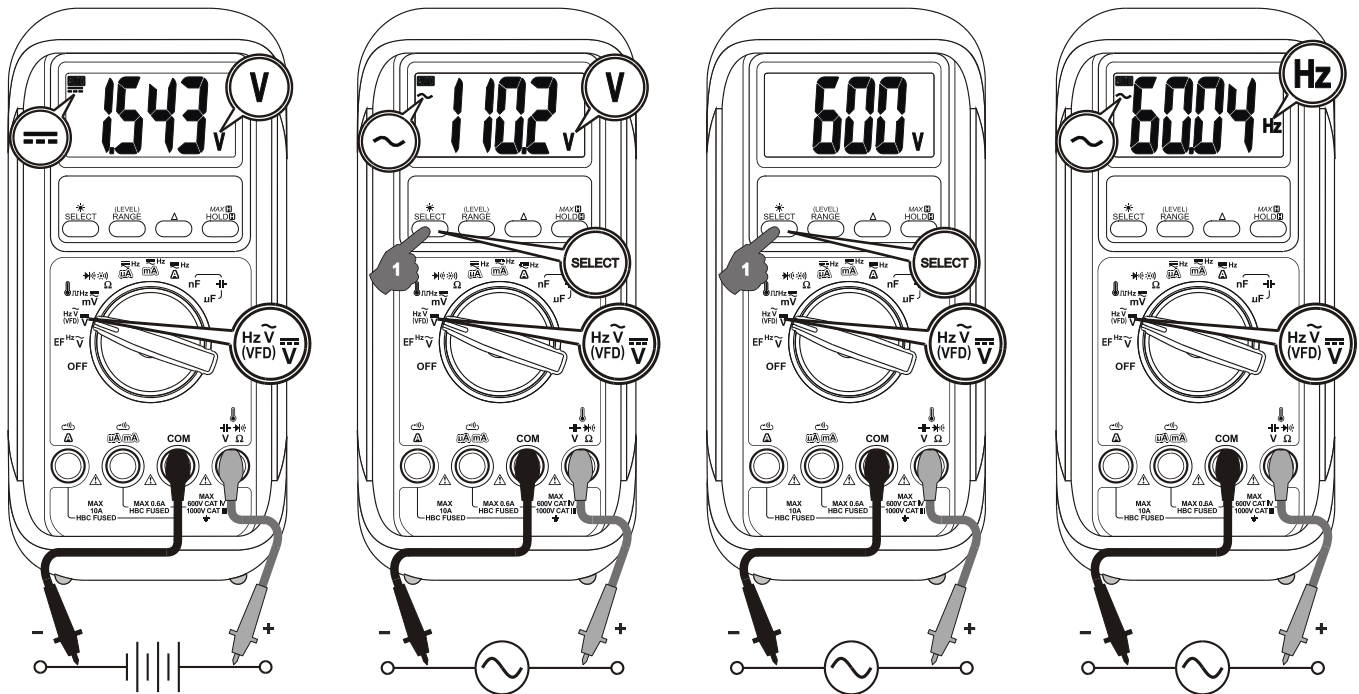

Note: *VFD-ACV* and *VFD-Hz* are equipped with a digital low-pass filter (DSP) and are capable of handling **VFD** (Variable Frequency Drives) signals for fundamental V & Hz readings. It also improves ACV and Hz reading stability when being used in most electrically noisy environments.

Note: Input sensitivity varies automatically with the function range selected while activating the *VFD-Hz* function. 600V function range has the highest and the 1000V range has the lowest. When activated, the trigger voltage range will be displayed right before the Hz readings start. Press momentarily the **RANGE** button can manually select another trigger voltage range. It is recommended to first measure the signal voltage level and activate the Hz function in that range to get the most appropriate trigger level. If the Hz reading becomes unstable, select lower sensitivity to avoid electrical noise. If the reading shows zero, select higher sensitivity.

DCmV; ACmV; Logic-level Hz (Models 2807 & 2805 only); °C/°F (Model 2807 only)
 Inputs are made via the terminals **COM/V**. Startup defaults to **DCmV** Function. Press the **SELECT** button momentarily to select the subject functions in sequence.

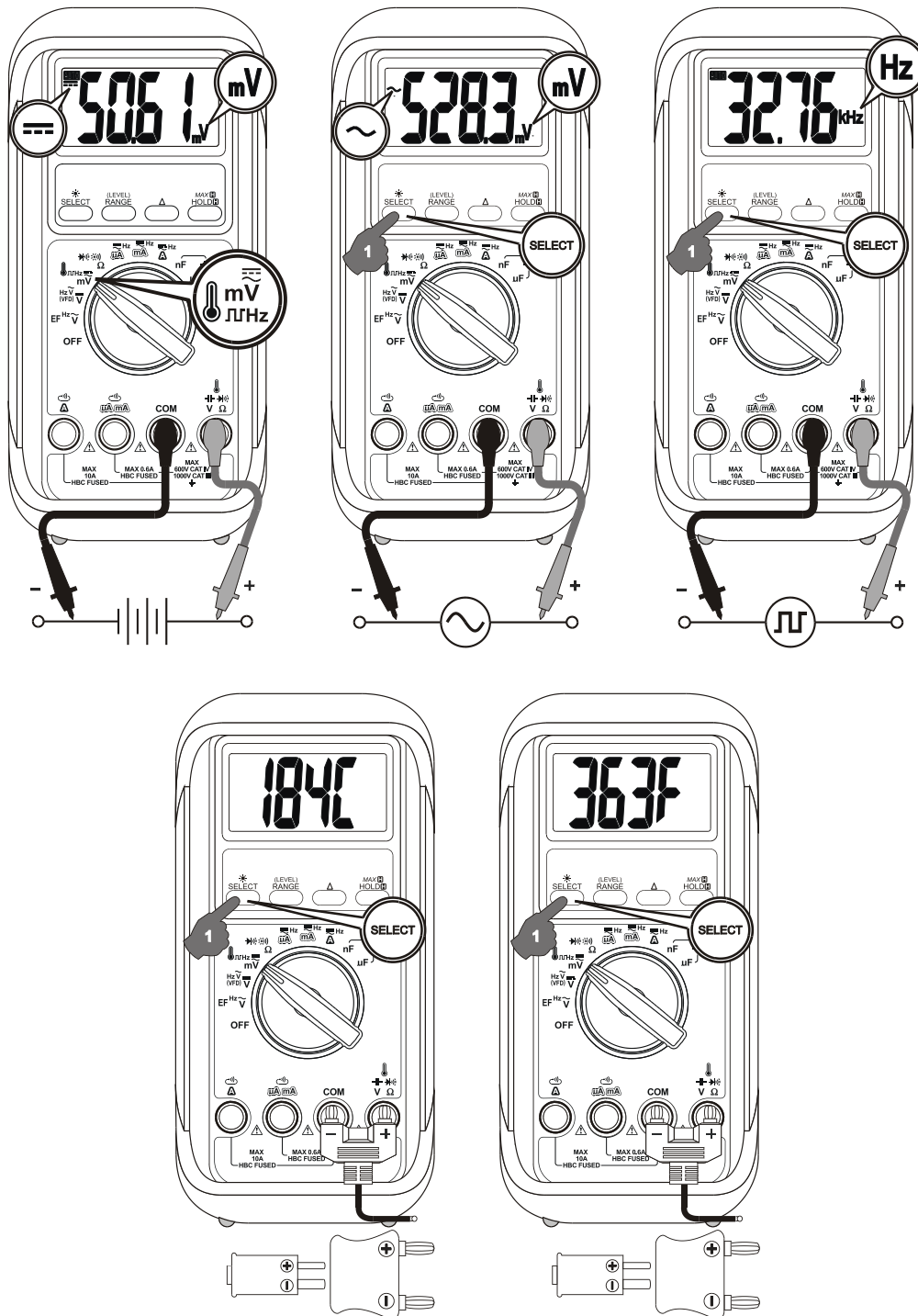

Note:

1) In ACmV function:

1-1) ACmV startup defaults to the AC 600.0mV range. Auto-ranging is not available. Press the RANGE button momentarily to toggle to the AC 60.00mV range for extended resolution.

1-2) Using the ACmV function in a composite signal beyond the peak levels specified in the specifications will saturate the respective ranges and produce false results. Instead, the meter shows OL with both DC & AC icons when the peak value is exceeded in this regard. Suspected signal levels can be verified with the DCV and ACV functions.

1-3) To measure ACmV signals coupled merely in AC nature when required, it is recommended to add in series an appropriate DC blocking capacitor in the measurement loop.

2) In temperature function:

2-1) Be sure to insert the banana-plug type-K temperature bead-probe with correct **+** **-** polarities. Banana-pins to type-K socket adapter Bkb32 (Optional purchase) can be used to accept other type-K probes using standard miniature plugs.

2-2) Temperature accuracies assume the meter interior has the same temperature (isothermal stage) as the ambient, particularly at the plug of the probe being used, for a correct junction voltage compensation. Allow the meter interior temperature to catch up with that of the plug after a sudden change in the measuring environment and hence the ambient temperature. This can take up to an hour, for changes $> 5^{\circ}\text{C}$, within a low ventilated sturdy meter housing. The uncompensated temperature differences, if any, will be reflected as offsets on the meter readings.

2-3) $^{\circ}\text{F}$ selection can be left out as factory calibration default for countries that only accept metric units.

Ω Resistance; BeepLit™ Continuity; & BeepLit™ Diode

Inputs are made via the test lead terminals **COM**/ Ω . Startup defaults to Ω Resistance. Press the **SELECT** button momentarily to select the subject functions in sequence.

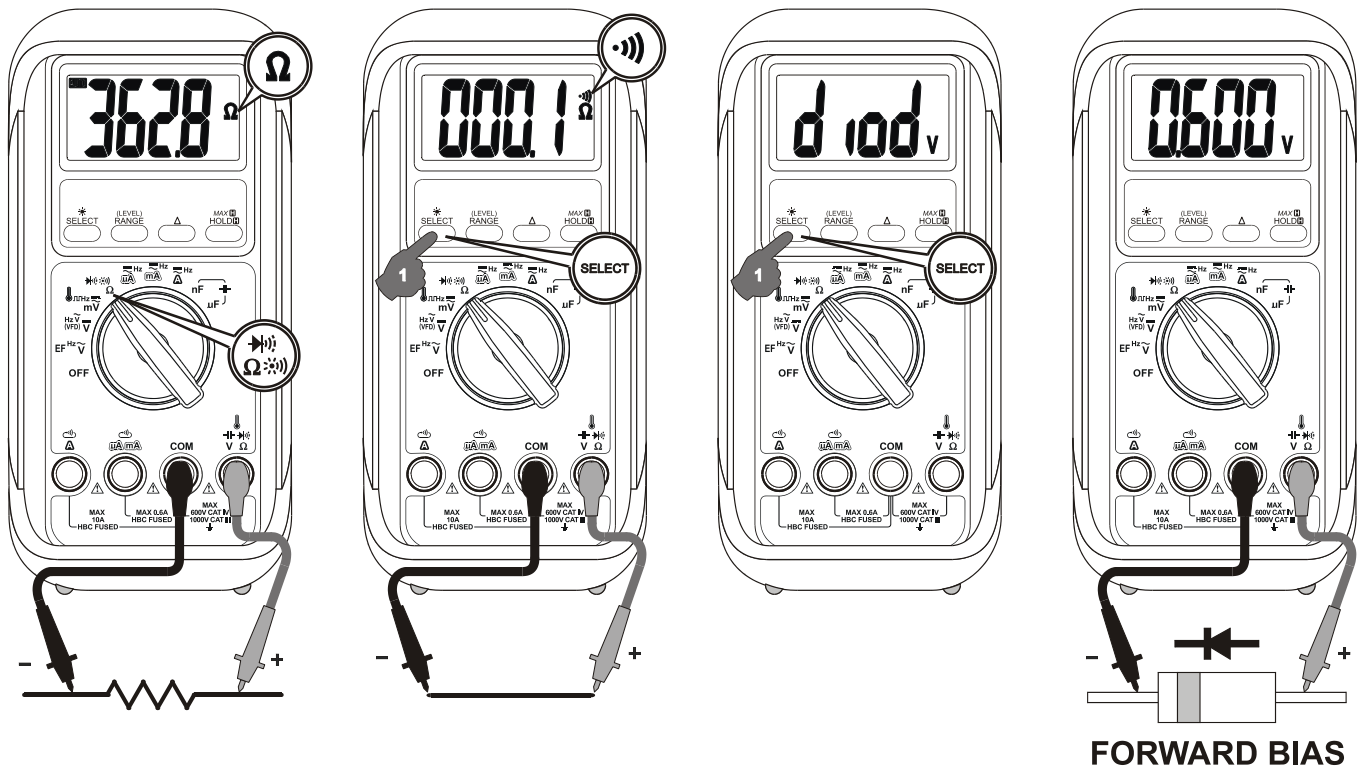

BeepLit™ Continuity

This function is having improved convenience for checking wiring connections and operation of switches. The resistance threshold is being used. A continuous beep sound together with display backlight flashing indicates a complete wire. Such audible and visible indications improve continuity readabilities in noisy working environments.

BeepLit™ Diode

● **Reading indication:** Forward voltage drop (forward-biased) for a good silicon diode is between 0.400V to 0.900V. A higher reading indicates a leaky diode (defective). A zero reading indicates a shorted diode (defective). An over-range display indicates an open diode (defective). Reverse the test leads connections (reverse biased) across the diode. The digital display shows an over-range if the diode is good. Any other readings indicate the diode is resistive or shorted (defective).

● **BeepPass™ indication (Short-beep):**

When the display reading drops across 0.850V, the BeepPass™ indication gives a short beep sound to signal a Good forward voltage drop of common diodes.

● **BeepLit™ indication (Continuity):**

If the reading further drops below 0.100V, the BeepLit™ indication gives a continuous beep sound together with the display backlight flashing to indicate a shorted diode or a complete wire. It is similar to that of the resistive BeepLit™ Continuity function but this BeepLit™ indication, instead, is based on the voltage threshold to indicate continuity.

Note: Using **Resistance**, **BeepLit™ Continuity**, or **BeepLit™ Diode** function in a live circuit will produce false results and may damage the meter. In many cases, the component(s) under test must be disconnected from the circuit to obtain an accurate measurement reading.

DC μ A; AC μ A; AC μ A-Hz (Models 2805 & 2807 only)

Inputs are made via the test lead terminals **COM/ μ A mA**. Startup defaults to **DC μ A**. Press the **SELECT** button momentarily to select the subject functions in sequence.

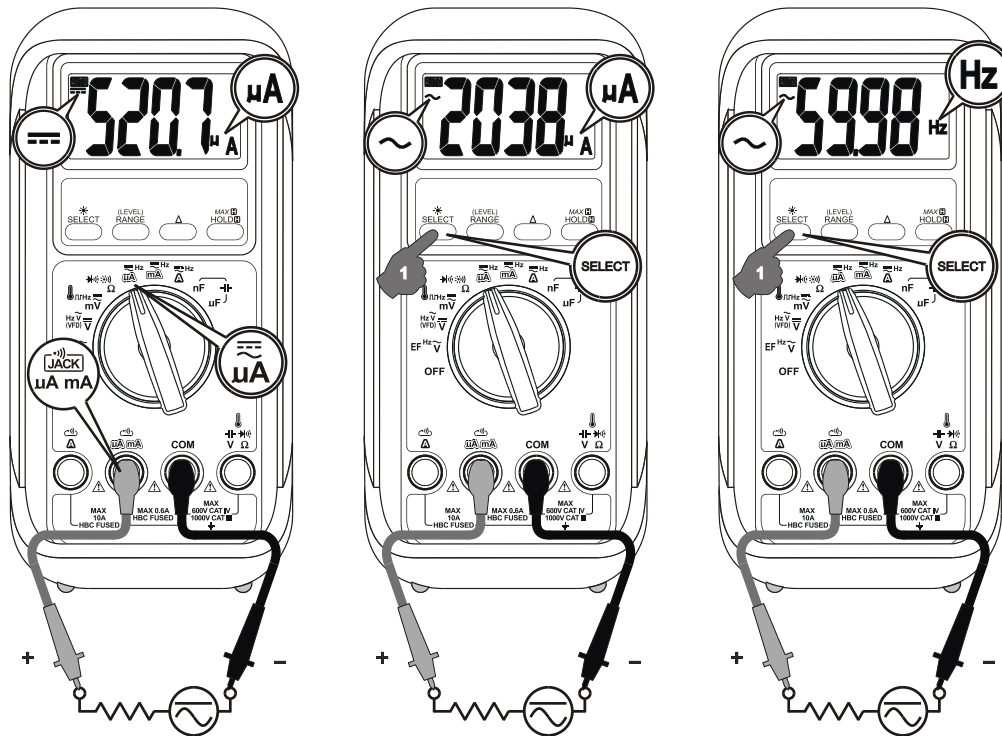

DCmA; ACmA; ACmA-Hz (Models 2805 & 2807 only)

Inputs are made via the test lead terminals **COM/ μ A mA**. Startup defaults to **DCmA**. Press the **SELECT** button momentarily to select the subject functions in sequence.

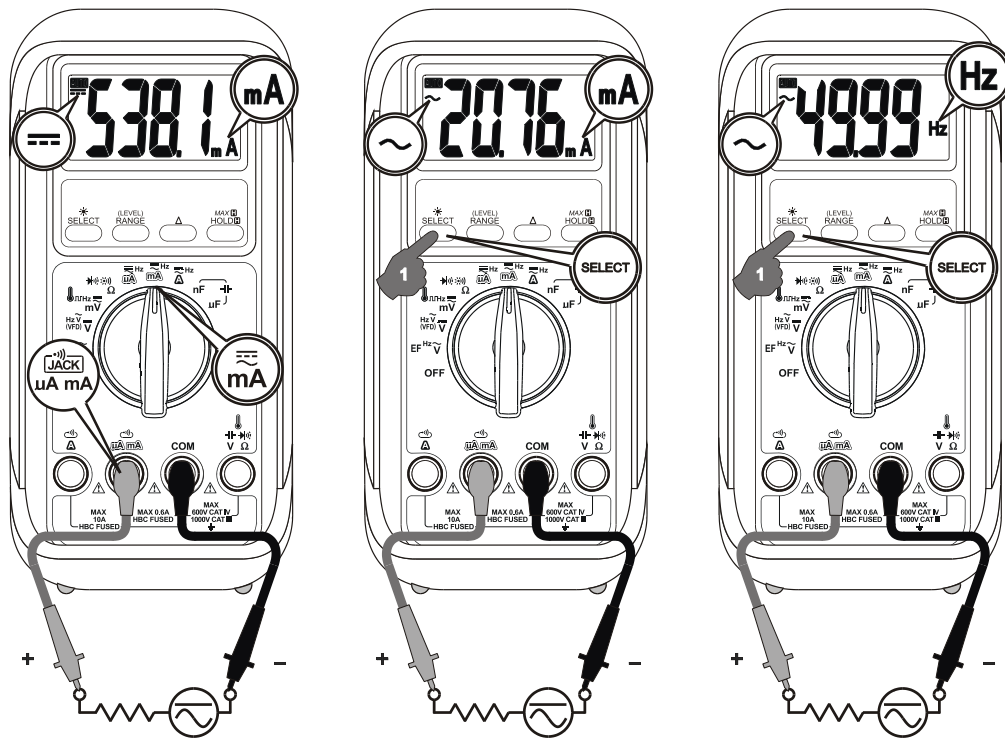

DCA; ACA; ACA-Hz (Models 2805 & 2807 only)

Inputs are made via the test lead terminals **COM/A**. Startup defaults to **DCA**. Press the **SELECT** button momentarily to select the subject functions in sequence.

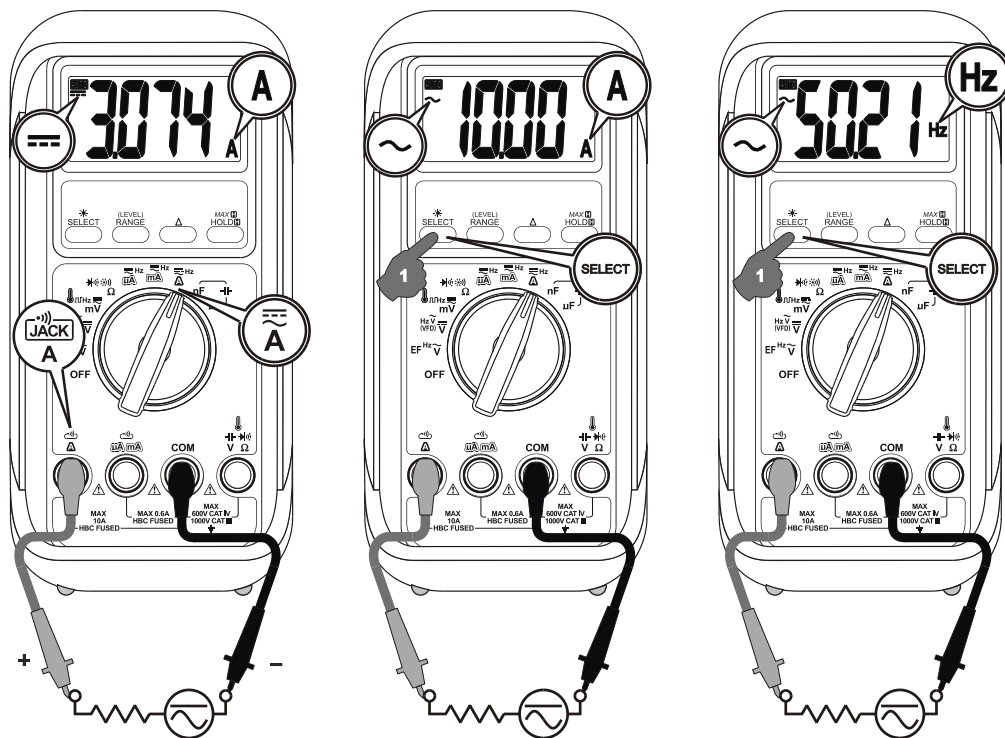

-||- (nF & μ F) Capacitance (Models 2805 & 2807 only)

Inputs are made via the test lead terminals **COM/-||-**. Turn the rotary switch to select measurements in **nF** or in **μ F**. There are 3 auto-ranges (20.00, 200.0, and 2000) in each unit position making it 6 ranges altogether in the capacitance function.

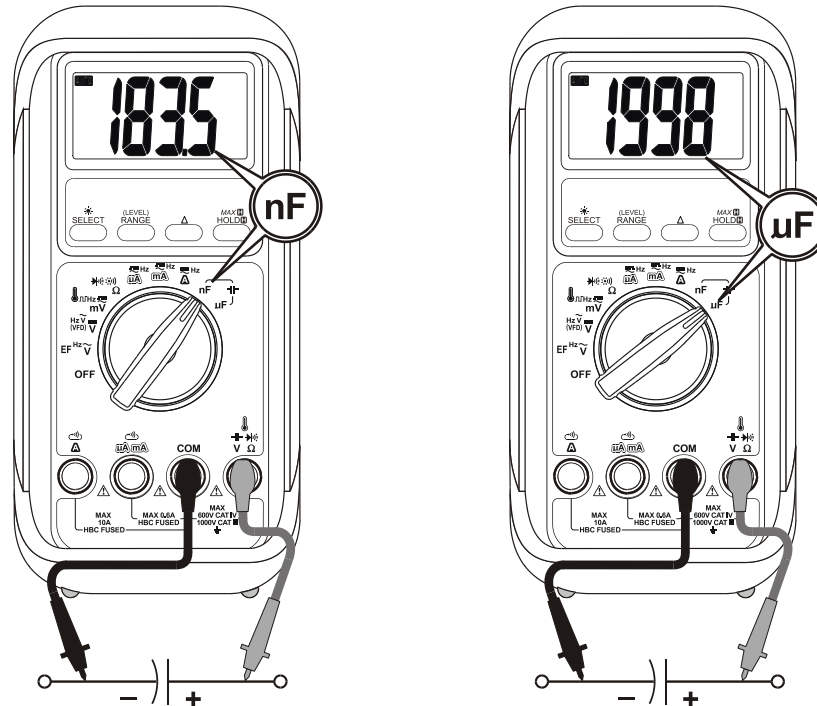

Note: Discharge capacitor(s) before making capacitance measurements. Large-value capacitors should be discharged through an appropriate resistance load. Using the Capacitance function in a live circuit will produce false results and may damage the meter. In many cases, the suspected component(s) must be disconnected from the circuit to obtain accurate measurement readings.

Manual-ranging Override (Voltage, Current, and Ω functions only)

Press the **RANGE** button momentarily to select manual-ranging. The meter will remain in the range it was in; the LCD **AUTO** turns off. Press the button momentarily again to select the next range in sequence. Press and hold the button for 1 second or more to resume auto-ranging.

HOLD (with Hold-alert™ Warning)

HOLD feature freezes the display reading and stops further measurements for later views. LCD “**H**” turns on flashing, and the frozen reading also flashes; it is the Hold-alert™ feature to warn the user of a displaying reading that is inactive. Press the **HOLD** button momentarily to toggle the **HOLD** feature.

MAX HOLD

Press the “**MAX H**” button for one second or more to activate **MAX HOLD** feature. LCD **MAX** & **H** turn on; Auto-Power-Off is disabled automatically; the meter beeps when a new **MAX** (maximum) reading is updated. When activated, the measuring speed (reading update rate) will be boosted to 40 times per second to capture RMS reading surges in the Voltage & Current functions; the speed remains unchanged in all other functions. Press the button for 1 second or more to exit.

Relative Δ mode

Relative Δ mode allows the user to offset the meter consecutive measurements with the main-display displaying reading as the reference value. LCD “ **Δ** ” turns on. Press the **Δ** button momentarily to toggle **Relative Δ** mode.

LCD Backlight and Auto-Backlight-Off (ABO)

Press the **SELECT** button for 1 second or more to toggle the LCD backlight. The **ABO** mode turns the LCD backlight off automatically after around 32 minutes of backlight activation to extend battery life. See **Power-on Options** section for disabling **ABO**.

Intelligent Auto-Power-Off (iAPO)

The **iAPO** mode turns the meter off automatically to extend battery life after idling around 32 minutes of no specified activities, where applicable, below:

- 1) Rotary switch or push button operation
- 2) Significant measuring reading of above 8.5% of its range
- 3) Non-over-range reading for Resistance, Continuity, or Diode function
- 4) Non-zero reading for Hz function
- 5) Significant bar-segment indication in EF-Detection function

In other words, the meter will intelligently reset the **iAPO** mode when it is under normal measurements. To wake the meter up from **iAPO**, press the **SELECT** or **HOLD** button momentarily, or turn the rotary switch OFF and then back on. Always turn the rotary switch to the OFF position when the meter is not in use.

Power-on Options

☉ Disabling both iAPO and ABO

Press and hold the **SELECT** button while powering on the meter to disable both **iAPO** and **ABO** features temporarily during the power-on session. The LCD will display “**dAPO**” to confirm selection before the **SELECT** button is released.

☉ Shortening APO idling time for inspection

Press and hold the **HOLD** button while powering on the meter can shorten the **iAPO** idling time to about 8 seconds temporarily during the power-on session. This mode is designed mainly for production verification use.

☉ Showing all LCD segments for inspection

Press and hold the **RANGE** or **Relative** button while powering on the meter can hold and show all LCD segments before the button is released. This mode is designed mainly for production verification use.

5) MAINTENANCE

Note: *To avoid electrical shock, disconnect the meter from any circuit, remove the test leads from the input jacks, and turn OFF the meter before opening the case. Do not operate with open case.*

Trouble Shooting

If the instrument fails to operate, check batteries and test leads etc., and replace as necessary. Double-check the operating procedure as described in this user's manual. Refer to the LIMITED WARRANTY section for obtaining calibration, repairing, or warranty service.

Accuracy and Calibration

Accuracy is specified for a period of one year after calibration. Periodic calibration at intervals of one year is recommended to maintain meter accuracy.

Cleaning and Storage

Periodically wipe the meter and the test probe assembly with a damp cloth and mild detergent. Do not use abrasives or solvents. Allow drying completely before operating. If the meter is not to be used for periods of longer than 60 days, remove the batteries and store them separately.

Battery and Fuse replacement

Battery use:

Standard 1.5V AAA Size (IEC R03) battery X 2

Fuses use:

Fuse (F1) for μ A-mA current input:

0.63A/1000V ac & dc, IR 10kA, F fuse; or better. Dimensions: 6 x 32 mm

Fuse (F2) for A current input:

11A/1000V ac & dc, IR 20kA, F fuse; or better. Dimensions: 10 x 38 mm

Battery replacement for models with battery access door:

Loosen the 2 screws from the battery access door of the case bottom. Lift the battery access door and thus the battery compartment up. Replace the batteries. Put back the battery access door and re-fasten the 2 screws.

Fuse replacement (and also Battery replacement for the splash-proof version without battery access door):

Remove the battery access door as described above (not applicable for the splash-

proof version).

Loosen the 4 screws from the case bottom. Lift the end of the case bottom nearest the input jacks until it unsnaps from the case top. Replace the blown fuse(s) and/or the batteries of the splash-proof version. Put back the case bottom; ensure that all the gaskets are properly seated and the two snaps on the case top (near the LCD side) are engaged. Re-fasten the 4 screws.

Put back the battery access door and re-fasten the 2 screws (not applicable for the splash-proof version).

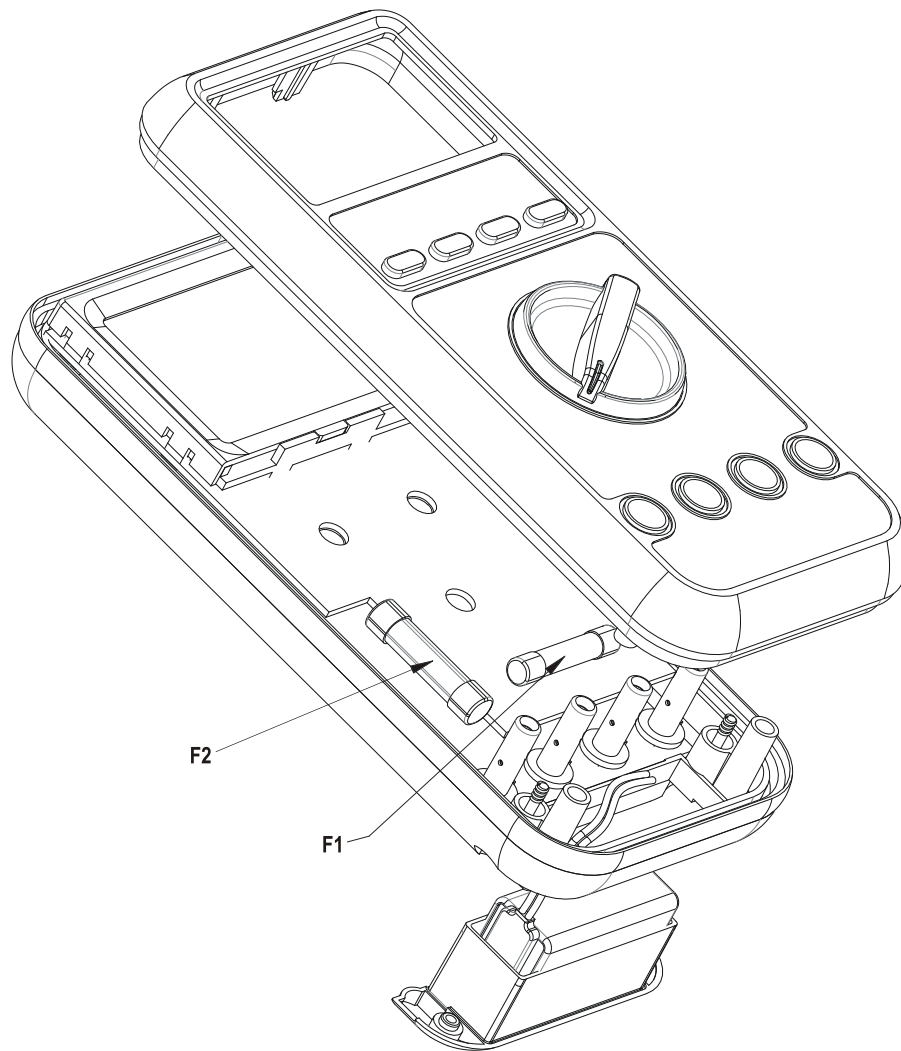

GENERAL SPECIFICATIONS

Display: 3-5/6 digits 6,000 counts

Update Rate: 5 per second nominal

Operating Temperature: -10°C to 50°C

Relative Humidity: Maximum relative humidity 80% for temperature up to 31°C decreasing linearly to 50% relative humidity at 50°C

Altitude: Operating below 2000m

Storage Temperature: -20°C ~ 60°C, < 80% R.H. (with battery removed)

Temperature Coefficient: Nominal 0.15 x (specified accuracy)/ °C @ (-10°C ~ 18°C or 28°C ~ 50°C), or otherwise specified

Sensing: True RMS sensing

Pollution Degree: 2

Safety: Certified per IEC/UL/EN61010-1 Ed. 3.1, IEC/UL/EN61010-2-033 Ed. 2.0, IEC/UL/EN61010-031 Ed. 2.0 and the corresponding CAN/CSA-C22.2 regulations to Measurement Categories: CAT III 1000V and CAT IV 600V

Transient Protection: 8.0kV (1.2/50µs surge)

E.M.C.: Meets EN61326-1:2013

mV, Diode, Ohm, & Temperature; in an RF field of 1V/m:

Total Accuracy = Specified Accuracy + 100 digits

Other functions; in an RF field of 3V/m:

Total Accuracy = Specified Accuracy + 100 digits

Overload Protection:

µA & mA: 0.63A/1000V DC/AC rms, IR 10kA, F fuse; or better

A: 11A/1000V DC/AC rms, IR 20kA, F fuse; or better

V: 1100V DC/AC rms

mV, Ohm, & others: 1000V DC/AC rms

Low Battery: Below approx. 2.5V

Power Supply: 1.5V AAA Size battery X 2

Power Consumption (typical): 3.2mA

iAPO Consumption (typical): 10µA

iAPO Timing: Idle for approx. 32 minutes

Accessories: Test lead set, User's manual, Banana-plug type-K thermocouple (Model 2807 only)

Optional purchase accessories: BKB32 banana-plug to type-K socket plug adaptor (Model 2807 only)

Special Features: VFD-ACV & VFD-Hz; Hi/Lo EF-Detection (NCV & Single pole); Display Hold w/Hold-alert™ warning; MAX Hold; BeepLit™ Diode w/BeepPass™ indication; BeepLit™ Continuity; Relative-Zero mode; Backlighted LCD display;

BeepJack™ audible & visible input warning

Electrical Specification

Accuracy is given as \pm (% of reading digits + number of digits) or otherwise specified @ $23^{\circ}\text{C} \pm 5^{\circ}\text{C}$

AC Voltage & Current accuracies are specified from 1 % to 100 % of range or otherwise specified. Maximum Crest Factor <2:1 at full scale & <4:1 at half scale, and with signal component frequencies limited to the specified bandwidth of the AC functions for non-sinusoidal waveforms

AC Voltage

RANGE	Accuracy
50Hz ~ 60Hz	
60.00mV ¹⁾ , 600.0mV ²⁾	1.0% + 3d
6.000V, 60.00V, 600.0V, 1000V	0.7% + 3d
45Hz ~ 500Hz	
60.00mV ¹⁾ , 600.0mV ²⁾	2.0% + 3d
6.000V, 60.00V, 600.0V, 1000V	2.0% + 3d
500Hz ~ 1kHz	
60.00mV ¹⁾ , 600.0mV ²⁾	2.0% + 3d
6.000V, 60.00V, 600.0V, 1000V	Unspecified

Input Impedance: 10M Ω , 20pF nominal

¹⁾Signal peak absolute values, including DC bias, less than 130mV_{peak}

²⁾Signal peak absolute values, including DC bias, less than 1300mV_{peak}

VFD-ACV (with Low Pass Filter)

RANGE	Accuracy ¹⁾
10 ~ 100Hz	
600.0V, 1000V	1.0% + 3d
100 ~ 400Hz	
600.0V, 1000V	10.0% + 3d ²⁾

¹⁾Not specified for fundamental frequency > 400Hz

²⁾Accuracy linearly decreases from 1% + 3d @100Hz to 10% + 3d @400Hz

DC Voltage

RANGE	Accuracy
60.00mV, 600.0mV, 6.000V	0.3% + 2d
60.00V	0.4% + 2d
600.0V	0.2% + 2d
1000V	0.4% + 2d

Input Impedance: 10M Ω , 20pF nominal

Ohm

RANGE ¹⁾	Accuracy
600.0 Ω , 6.000k Ω	0.3% + 3d
60.00k Ω , 600.0k Ω	0.5% + 3d
6.000M Ω ²⁾ , 60.00M Ω ³⁾	0.9% + 2d ⁴⁾

¹⁾Open Circuit Voltage: 1.6VDC typical

²⁾Constant Test Current: 0.2 μ A Typical

³⁾Constant Test Current: 0.02 μ A Typical

⁴⁾5%+20d @ >30M Ω

BeepLit™ Continuity Tester

Continuity Threshold: Between 30 Ω and 480 Ω

Continuity ON Response Time: <15ms

Audible Indication: Beep sound

Visible Indication: LCD Backlight

Capacitance (Models 2805 & 2807 only)

RANGE	Accuracy
20.00nF, 200.0nF	1.5% + 8d
2000nF	1.5% + 3d
20.00 μ F, 200.0 μ F, 2000 μ F	

Accuracies with film capacitor or better

BeepLit™ Diode Tester

RANGE	Accuracy	Test Current (Typical)	Open Circuit Voltage
3.0000V	0.9% + 2d	0.3mA	< 3.2 VDC

BeepPass™ Indication (Short-beep): Drop Across 0.850V

BeepLit™ Indication (Continuity) Threshold: < 0.100V

Audible Indication: Beep Sound

Visible Indication: LCD Backlight

DC Current

RANGE	Accuracy	Burden Voltage
600.0μA, 6000μA	1.0% + 3d	0.1mV/μA
60.00mA, 600.0mA	0.7% + 3d	3.0mV/mA
6.000A, 10.00A ¹⁾		25mV/A

¹⁾10A continuous, >10A to 20A for 30 seconds max with 5 minutes cool down interval

AC Current

RANGE	Accuracy	Burden Voltage
50Hz ~ 500Hz		
600.0μA, 6000μA	1.5% + 3d	0.1mV/μA
60.00mA, 600.0mA	1.0% + 5d	3.0mV/mA
6.000A, 10.00A ¹⁾		25mV/A

¹⁾10A continuous, >10A to 20A for 30 seconds max with 5 minutes cool down interval

Logic Frequency (Models 2805 & 2807 only)

Range	Sensitivity (Square wave)
5.00Hz – 300.0kHz	3Vpeak

Accuracy: 0.03% + 4d

Temperature (Model 2807 only)

RANGE	Accuracy ^{1) 2)}
-40.0°C ~ 0.0°C	1% + 2°C
0.0°C ~ 99.9°C	1% + 1°C
100°C ~ 400°C	
-40.0°F ~ 32.0°F	1% + 4°F
32.0°F ~ 99.9°F	1% + 2°F
100°F ~ 752°F	

°F selection can be left out as factory calibration default for countries that only accept metric units

¹⁾Accuracies assume the meter interior and the ambient have reached the same temperature (isothermal stage) for a correct junction voltage compensation. Allow enough settling time for a significant change in ambient temperature. It can take up to an hour for changes > 5°C

²⁾Type-K thermocouple range & accuracy not included

Line Frequency (Models 2805 & 2807 only)

Function	Sensitivity (Sine RMS)	Range
6V	5V	10Hz - 50kHz
60V	10V	10Hz - 50kHz
600V	50V	10Hz - 1kHz
1000V	500V	50Hz - 1kHz
VFD 600V	50V	10Hz - 1kHz
VFD 1000V	500V	50Hz - 1kHz
600µA, 6000µA	500µA	10Hz - 5kHz
60mA, 600mA	50mA	10Hz - 5kHz
6A, 10A	8A	50Hz - 1kHz

Accuracy: 0.03% + 4d

Non-Contact EF-Detection (Models 2807 only)

Bar-segment Indication	EF-H (Hi Sensitivity)	EF-L (Lo Sensitivity)
	Typical Voltage (Tolerance)	
-	15V (3V ~ 30V)	70V (30V ~ 120V)
--	30V (10V ~ 60V)	140V (60V ~ 240V)
---	60V (20V ~ 120V)	280V (120V ~ 480V)
----	120V (40V ~ 240V)	560V (240V ~ 960V)
-----	240V (>80V)	1000V (>900V)

Indication: Display bar-segments, backlight flashing, & beep tones in proportion to the field strength

Detection Frequency: 50/60Hz

Detection Antenna: Top end center of the meter

Probe-Contact EF-Detection: For more precise indications of live wires, such as distinguishing between live and ground connections, use direct contact testing with one single test-probe via the input terminal COM or V. The COM terminal (Black) has the best sensitivity.

LIMITED WARRANTY

BRYMEN warrants to the original product purchaser that each product it manufactures will be free from defects in material and workmanship under normal use and service within a period of one year from the date of purchase. BRYMEN's warranty does not apply to accessories, fuses, fusible resistors, spark gaps, varistors, batteries, or any product which, in BRYMEN's opinion, has been misused, altered, neglected, or damaged by accident or abnormal conditions of operation or handling.

To obtain warranty service, contact your nearest BRYMEN authorized agent or send the product, with proof of purchase and description of the difficulty, postage and insurance prepaid, to BRYMEN TECHNOLOGY CORPORATION. BRYMEN assumes no risk for damage in transit. BRYMEN will, at its option, repair or replace the defective product free of charge. However, if BRYMEN determines that the failure was caused by misused, altered, neglected, or damaged by accident or abnormal conditions of operation or handling, you will be billed for the repair.

THIS WARRANTY IS EXCLUSIVE AND IS IN LIEU OF ALL OTHER WARRANTIES, EXPRESSED OR IMPLIED, INCLUDING BUT NOT LIMITED TO ANY IMPLIED WARRANTY OR MERCHANTABILITY OR FITNESS FOR A PARTICULAR PURPOSE OR USE. BRYMEN WILL NOT BE LIABLE FOR ANY SPECIAL, INDIRECT, INCIDENTAL OR CONSEQUENTIAL DAMAGES.



BRYMEN TECHNOLOGY CORPORATION

TEL:+886 2 2226 3396

FAX:+886 2 2225 0025

<http://www.brymen.com>



PRINTED ON RECYCLABLE PAPER, PLEASE RECYCLE

COPYRIGHT © MMXXII Btc,

ALL RIGHTS RESERVED

P/N: 7M1C-1591-0000

PRINTED IN TAIWAN