

USER'S MANUAL

BM839 BM836

Digital Multimeter



1) SAFETY

This manual contains information and warnings that must be followed for operating the meter safely and maintaining the meter in a safe operating condition. If the meter is used in a manner not specified by the manufacturer, the protection provided by the meter may be impaired.

Terms in this manual

WARNING identifies conditions and actions that could result in serious injury or even death to the user.

CAUTION identifies conditions and actions that could cause damage or malfunction in the instrument.

WARNING

To reduce the risk of fire or electric shock, do not expose this product to rain or moisture. The meter is intended only for indoor use.

Observe proper safety precautions when working with voltages above 33 Vrms, 46.7 Vpeak or 70 VDC. These voltage levels pose a potential shock hazard to the user. Before and after hazardous voltage measurements, check the voltage function on a known source such as line voltage to determine proper meter functioning.

The meter meets UL/IEC/EN61010-1 Ed. 3.0, CAN/CSA C22.2 No. 61010-1 Ed. 3.0, UL/IEC/EN61010-2-033 Ed. 1.0 to Measurement CAT-III 1kV and CAT-IV 600V, AC & DC.









The accompanied test probe assembly meets UL/IEC/EN61010-031 Ed. 1.1 to the same meter ratings or better. IEC 61010-031 requires exposed conductive test probe tips to be $\leq 4\text{mm}$ for CAT III & CAT IV ratings. Refer to the category markings on your probe assemblies as well as on the add-on accessories (like detachable Caps or Alligator Clips), if any, for applicable rating changes.

Keep your hands/fingers behind the hand/finger barriers (of the meter and the test probe assembly, where applicable) that indicate the limits of safe access of the hand-held parts during measurements. Inspect lead wires, connectors, and probes for damaged insulation or exposed metal before using the meter. If any defects are found, replace them immediately. Only use the probe assembly provided with the meter or a UL Listed Probe Assembly to the same meter ratings or better.

CAUTION

Disconnect the test leads from the test points before changing functions.

International Electrical Symbols

	Marking of Electrical and Electronic Equipment (EEE). Do not dispose of this product as unsorted municipal waste. Contact a qualified recycler
	Caution! Refer to the explanation in this Manual
	Caution! Possibility of electric shock
	Earth (Ground)
	Meter protected throughout by Double Insulation or Reinforced insulation
	Fuse
	Direct Current (DC)
	Alternating Current (AC)
	Three-phase Alternating Current

Brief Information about Measurement Categories

Measurement Category IV is applicable to test and measuring circuits connected at the source of the building's low-voltage MAINS installation. Examples are measurements on devices installed before the main fuse or circuit breaker in the building installation.

Measurement Category III is applicable to test and measuring circuits connected to the distribution part of the building's low-voltage MAINS installation. Examples are measurements on distribution boards (including secondary meters), circuit-breakers, wiring, including cables, bus-bars, junction boxes, switches, socket-outlets in the fixed installation, and equipment for industrial use and some other equipment such as stationary motors with permanent connection to the fixed installation.

Measurement Category II is applicable to test and measuring circuits connected directly to utilization points (socket outlets and similar points) of the low-voltage MAINS installation. Examples are measurements on MAINS CIRCUITS of household appliances, portable tools and similar equipment.

2) CENELEC DIRECTIVES

The instruments conform to CENELEC Low-voltage directive 2014/35/EC, Electromagnetic compatibility directive 2014/30/EU and RoHS directive 2011/65/EU.

3) PRODUCT DESCRIPTION

Note: Top of the line model is used as representative for illustration purposes. Please refer to your particular model for function availability.

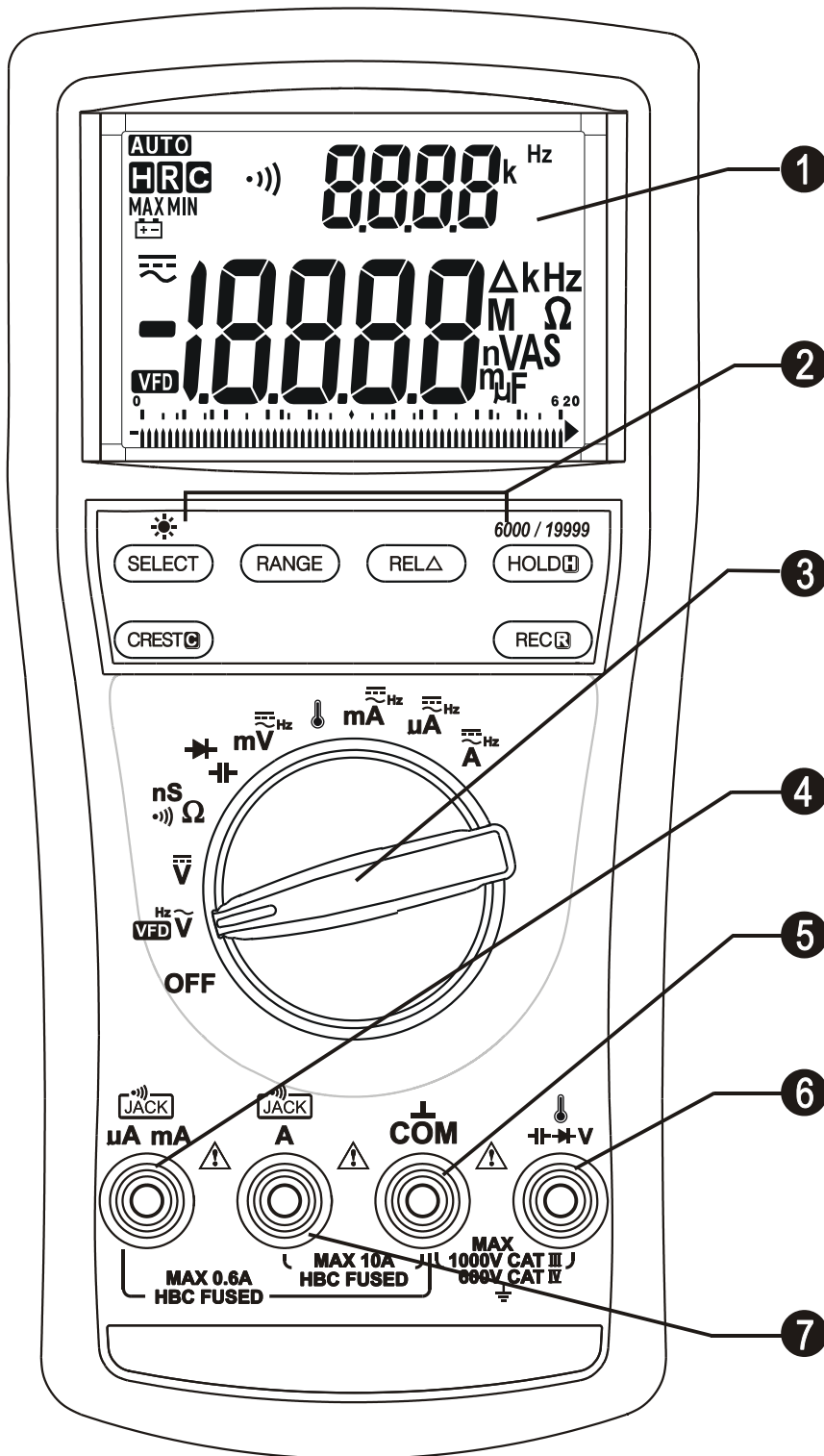

1) 4-1/2 digits 20000 counts & 3-5/6 digits 6000 counts selectable dual displays

2) Push-buttons for special functions & features

3) Selector to turn the Power On or Off and Select a function

4) Input Jack for mA/μA function positive input

5) Common (Ground reference) Input Jack for all functions

6) Input Jack for all functions EXCEPT A, mA and μA functions

7) Input Jack for A function positive input

Analog bar-graph

The analog bar graph provides a visual indication of measurement like a traditional analog meter needle. It is excellent in detecting faulty contacts, identifying potentiometer clicks, and indicating signal spikes during adjustments.

4) OPERATION

CAUTION

Before and after hazardous voltage measurements, test the voltage function on a known source such as line voltage to determine proper meter functioning.

ACV ^{+Hz} & VFD ACV ^{+Hz} functions

Press the **SELECT** button momentarily to toggle the subject functions. Last selection will be saved as power up default for repeat measurement convenience. For **ACV ^{+Hz}** function, press the **RANGE** button momentarily to select other ranges manually when needed. For **VFD ACV ^{+Hz}** function, default is set to 600V range to best cope with the measurements of most Variable Frequency Drives (VFD). Press the **RANGE** button momentarily to select 1000V range when needed.

DCV function

Turn Rotary Knob to **DCV** function position for measurements.

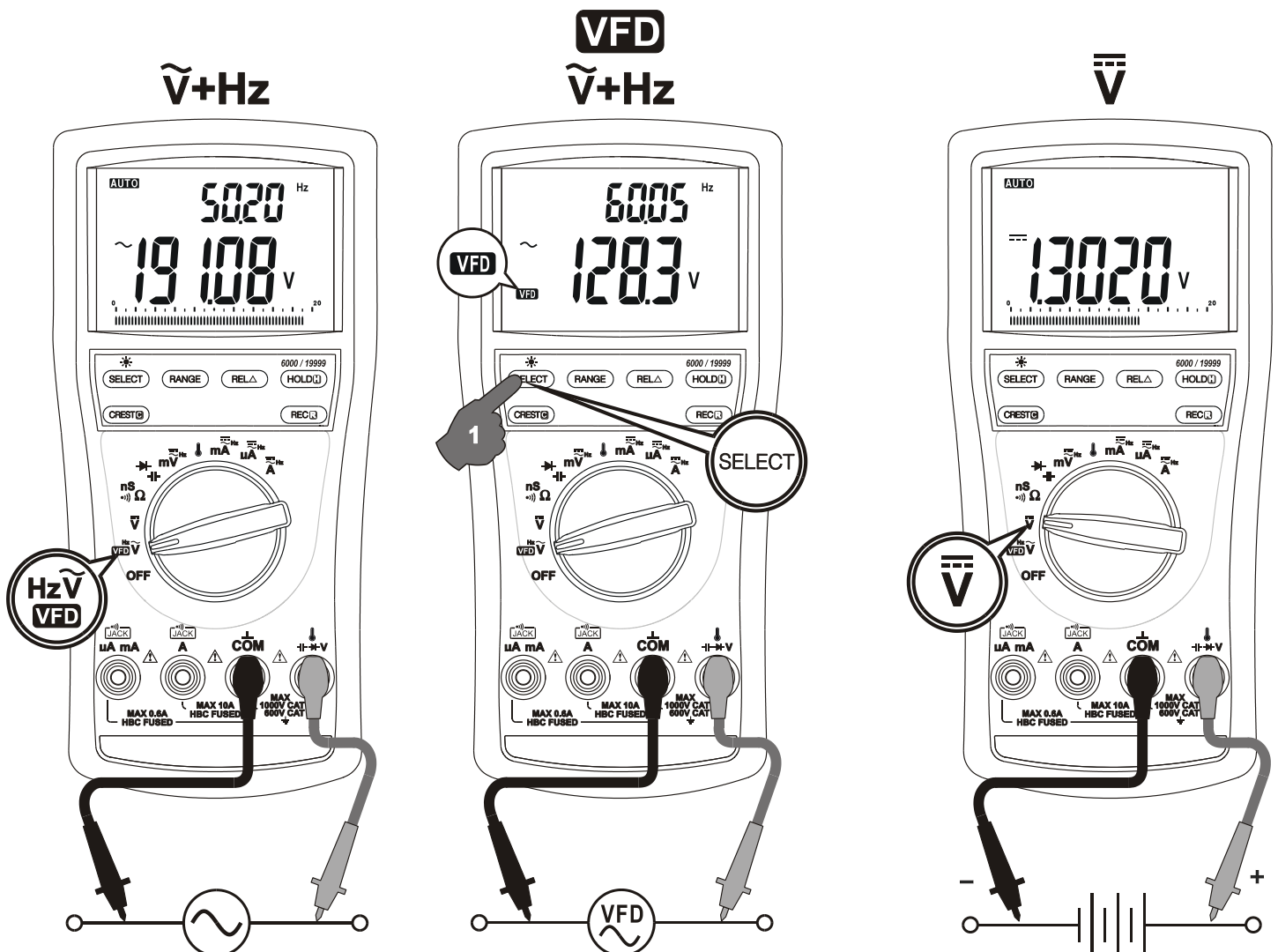

Ω Resistance, $\cdot\cdot\cdot$) BeepLit™ Continuity, nS Conductance functions

Press the **SELECT** button momentarily to select the subject functions. Last selection will be saved as power up default for repeat measurement convenience.

$\cdot\cdot\cdot$) **BeepLit™ Continuity** function is having improved convenience for checking wiring connections and operation of switches. A continuous beep tone together with flashing display backlight indicate a complete wire. Such audible and visible indications improve continuity readabilities in noisy working environments.

Conductance is the inverse of Resistance, that is $S=1/\Omega$ or $nS=1/G\Omega$. It virtually extends the Resistance measurements to the order of Giga-Ohms for leakage measurements.

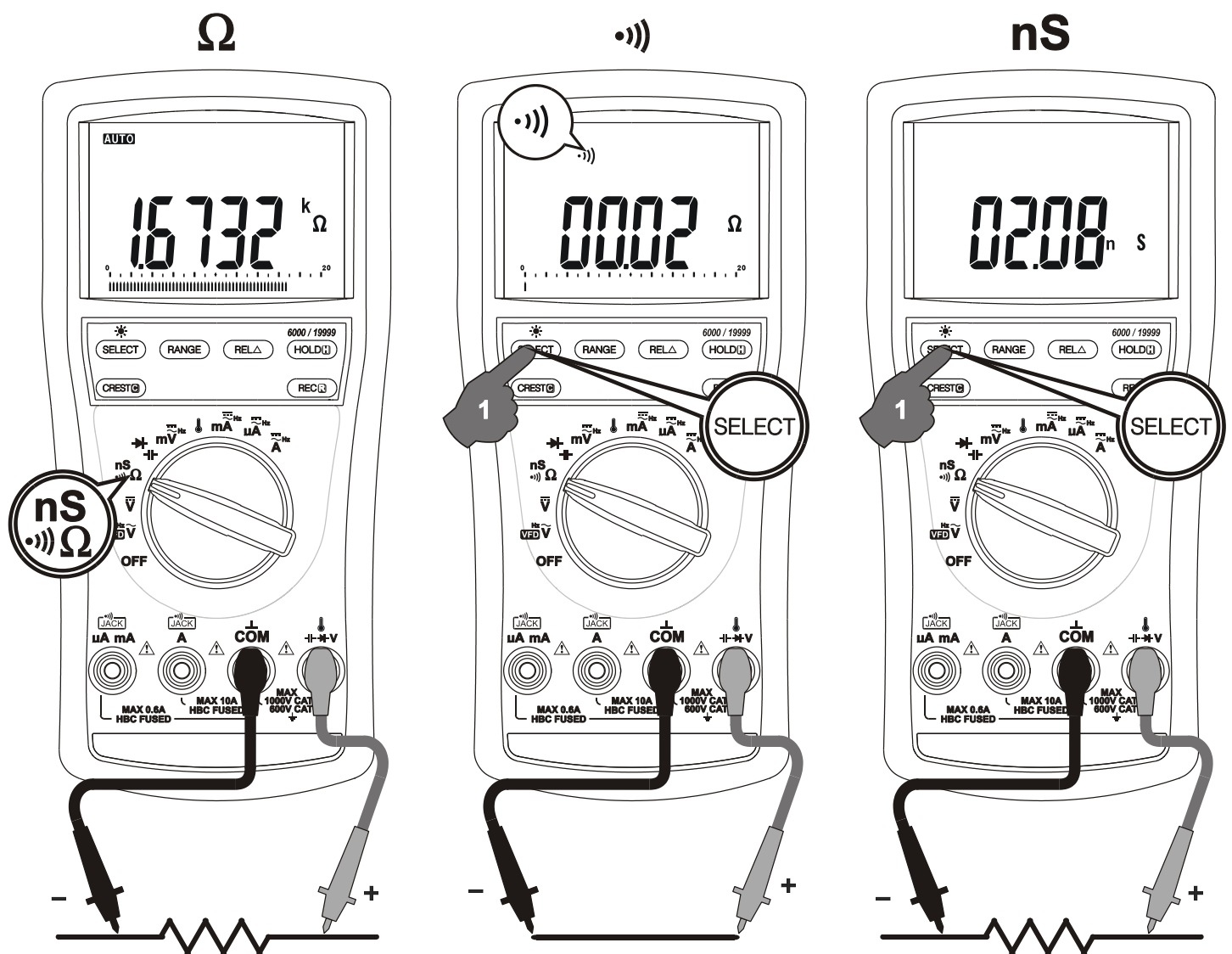

CAUTION

Using resistance, continuity or nS function in a live circuit will produce false results and may damage the instrument. In many cases the suspected component must be disconnected from the circuit to obtain an accurate reading

Auto leads resistance calibration

When entering the **200Ω** range *manually* by **RANGE** button for high precision low resistance measurement, this feature will prompt you to short the inputs for temporary test lead resistance calibration on this range.

The fastest way is to short the leads to auto-range to the **200Ω** range, then press the **RANGE** button momentarily. The display shows "Shrt". Keep shorting the leads for further 3 seconds until the display shows zero. The lead resistance is then temporarily compensated.

The compensation value stays until the next meter power reset, and can be as high as 5Ω. If you need a compensation value that is higher than that, Relative Zero mode is recommended.

→ Diode Test, ← Capacitance functions

Press the **SELECT** button momentarily to toggle the functions. Last selection will be saved as power up default for repeat measurement convenience.

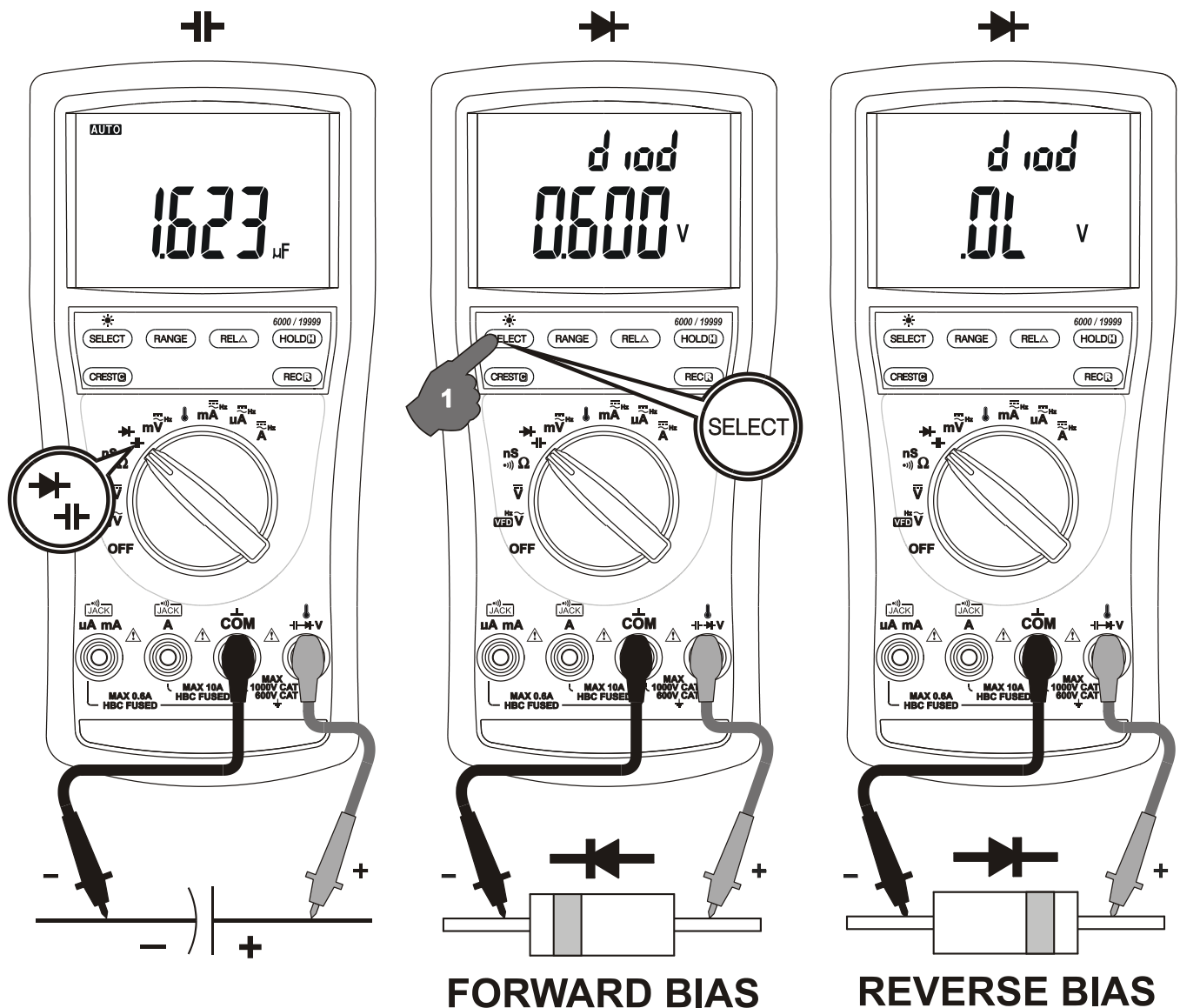

CAUTION

Discharge capacitors before making any measurement. Large value capacitors should be discharged through an appropriate resistance load.

Normal forward voltage drop (forward biased) for a good silicon diode is between 0.400V to 0.900V. A reading higher than that indicates a leaky diode (defective). A zero reading indicates a shorted diode (defective). An OL indicates an open diode (defective). Reverse the test leads connections (reverse biased) across the diode. The digital display shows OL if the diode is good. Any other readings indicate the diode is resistive or shorted (defective).

DCmV, ACmV +Hz functions

Press the **SELECT** button momentarily to toggle the subject functions. Last selection will be saved as power up default for repeat measurement convenience.

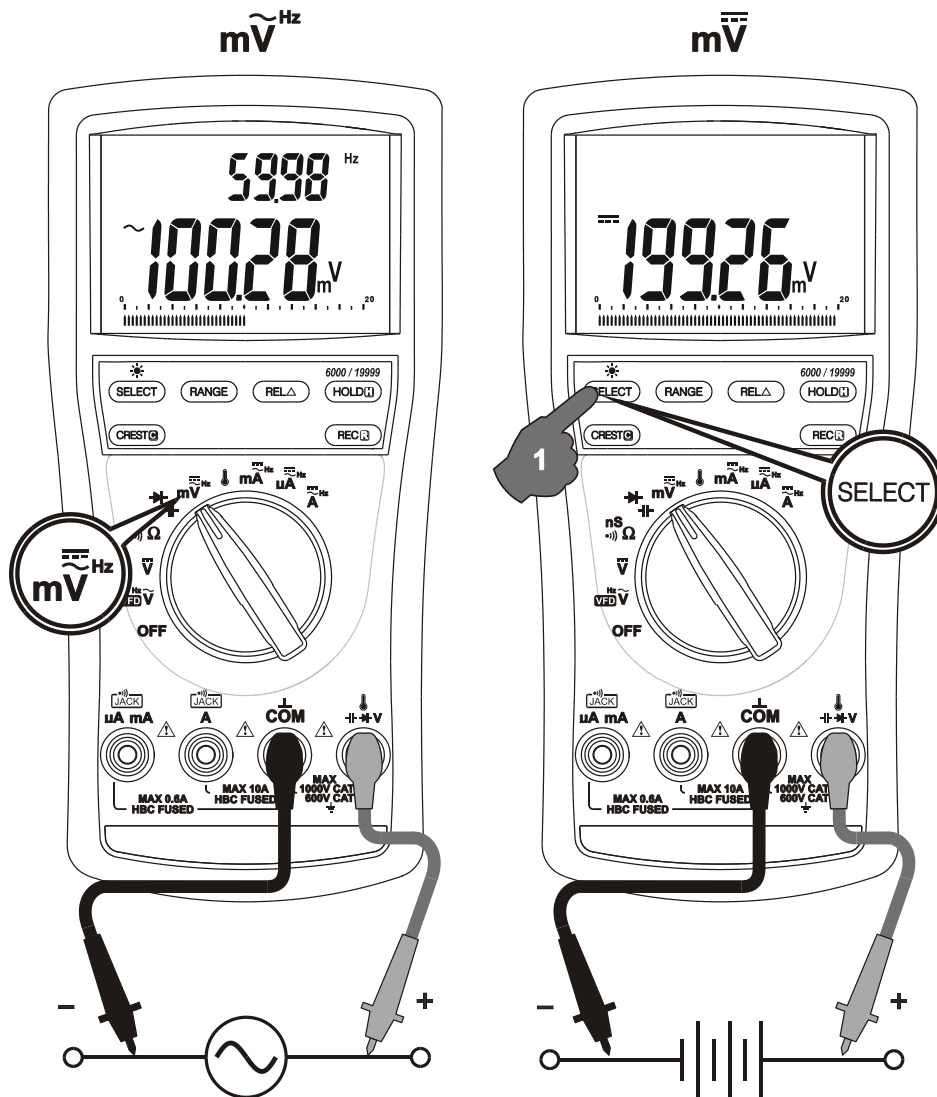

Temperature functions (Model 839 only)

Press **SELECT** button momentarily to toggle °C and °F readings. Last selection will be saved as power up default for repeat measurement convenience.

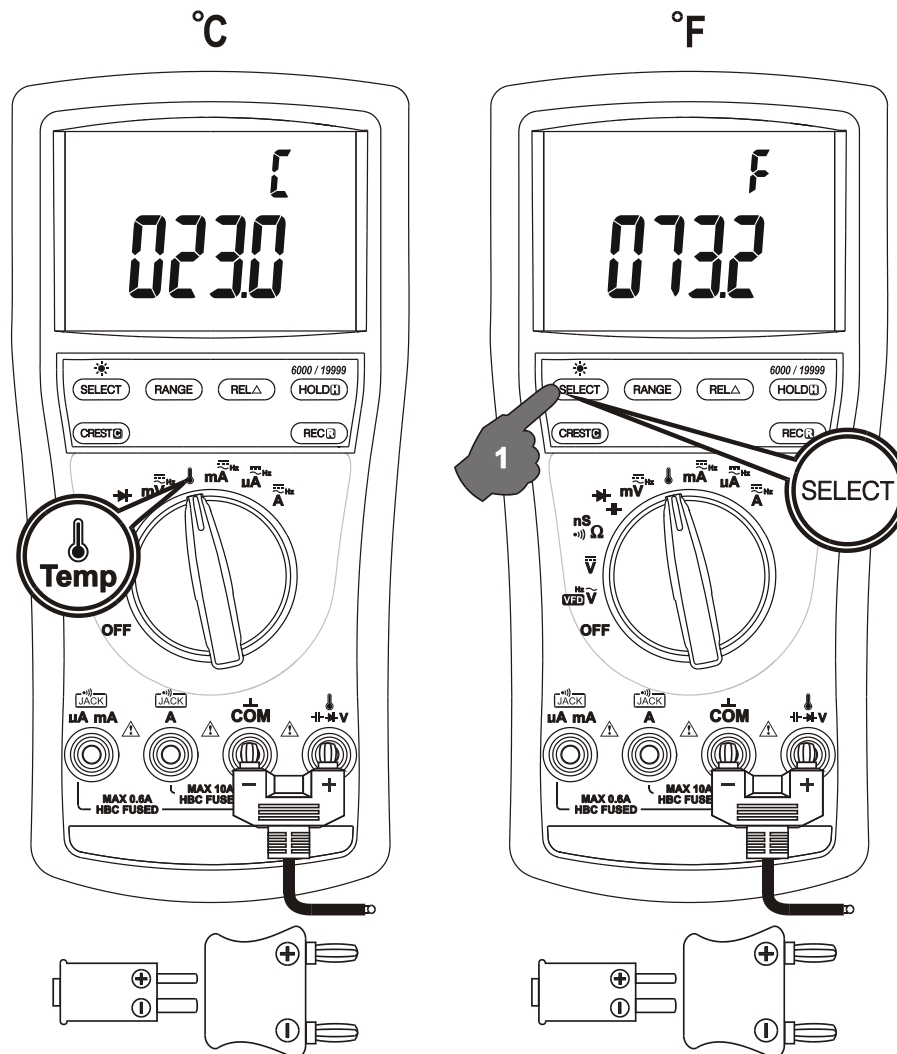

Note: Be sure to insert the banana plug type-K temperature bead probe Bkp60 with correct **+** **-** polarities. You can also use a plug adapter Bkb32 (Optional purchase) with banana pins to type-K socket to adapt other standard type-K mini plug temperature probes.

A, mA, μ A Current functions

Press the **SELECT** button momentarily to toggle the **DC** or **AC^{Hz}** of the subject functions. Last selection will be saved as power up default for repeat measurement convenience.

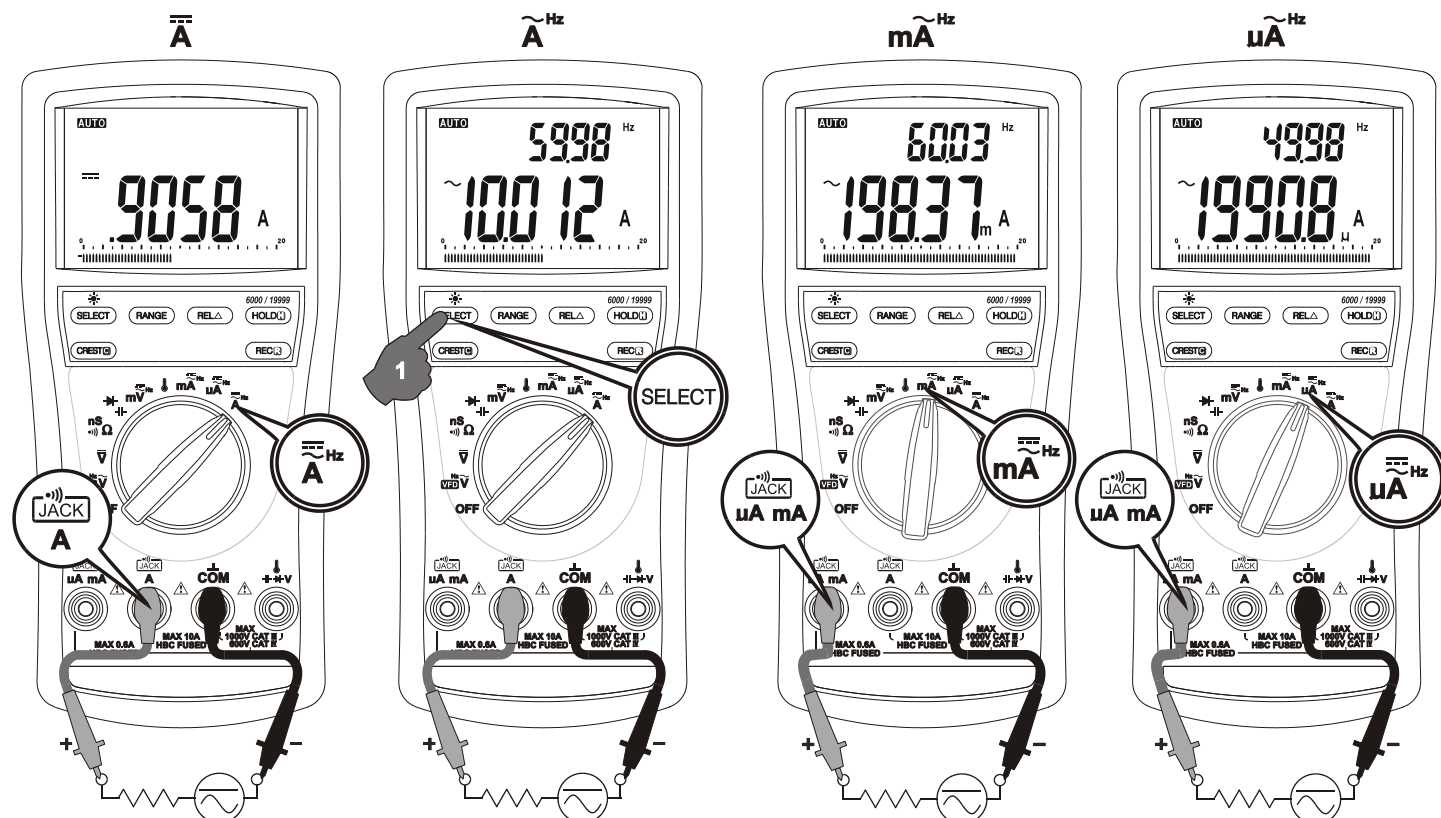

Backlighting display

Press the  button for 1 second or more to toggle the LCD backlight. The backlight will also be turned off automatically after approximate 10 minutes to extend battery life.

Auto- or Manual-ranging (ACV, DCV, Current & Ω functions only)

Press the **RANGE** button momentarily to select manual-ranging, and the meter will remain in the range it was in, the LCD **AUTO** turns off. Press the button momentarily again to select an adjacent range. Press and hold the button for 1 second or more to resume auto-ranging.

Δ Relative Zero mode

Relative-Zero allows the user to offset the meter consecutive measurements with the main display displaying reading as the reference value. LCD " Δ " turns on. Press the **RELA** button momentarily to toggle Relative-Zero mode.

Hold

The hold feature freezes the display for later view. LCD “**H**” turns on. Press the **HOLD** button momentarily to toggle the hold feature.

20000 counts High Resolution mode

Press the **6000/19999** button for one second or more to toggle between the Standard 6000 counts and 20000 counts High Resolution modes. The analog bar-graph full-scale shows “**6**” and “**20**” accordingly. Last selection is saved as power up default. 20000 counts High Resolution mode is available to AC/DC Voltage (except VFD-ACV^{+Hz}), AC/DC Current and Resistance functions.

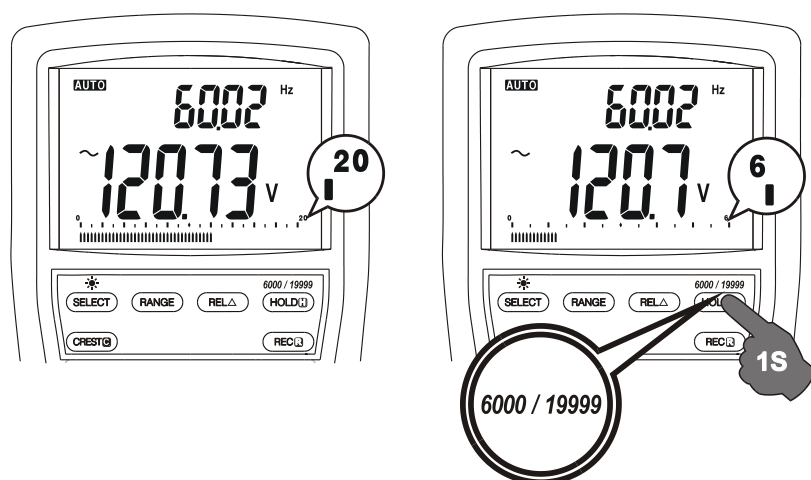

MAX/MIN Recording mode

Press **REC** button momentarily to activate MAX/MIN recording mode. The LCD “**R**” & “**MAX MIN**” turn on. The meter beeps when a new MAX (maximum) or MIN (minimum) reading is updated. Press the button momentarily to read the Real-time, MAX and MIN readings in sequence. Press the button for 1 second or more to exit MAX/MIN recording mode. When activated, Auto-Power-Off is disabled automatically.

5ms CREST capture mode

Press **CREST** button momentarily to activate CREST (Instantaneous Peak-Hold) mode to capture voltage or current signal duration as short as 5ms. The LCD “**C**” & “**MAX**” turn on. Press the button momentarily to read the MAX and MIN readings in sequence. Press the button for 1 second or more to exit CREST mode. Auto-Power-Off is disabled automatically in this mode.

Beep-Jack™ Input Warning

The meter beeps as well as displays “**InEr**” to warn the user against possible damage to the meter due to improper connections to the “**μA/mA**” or “**A**” input jack when other

functions, especially voltage function, is selected.

Set Beeper Off

Press the **RANGE** button while turning the meter on to temporarily disable the Beeper feature. Turn the rotary switch OFF and then back on to resume.

Auto-Power-off (APO)

The Auto-Power-off (APO) mode turns the meter off automatically to extend battery life after approximately 20 minutes of no rotary switch or push button operations. To wake up the meter from APO, press the **SELECT** or **CREST** button momentarily or turn the rotary switch OFF and then back on. Always turn the rotary switch to the OFF position when the meter is not in use.

Disabling Auto-Power-off

Press the **SELECT** button while turning the meter on to temporarily disable the Auto-Power-Off feature. Turn the rotary switch OFF and then back on to resume.

5) MAINTENANCE

WARNING

To avoid electrical shock, disconnect the meter from any circuit, remove the test leads from the input jacks and turn OFF the meter before opening the case. Do not operate with open case. Install only the same type of fuse or equivalent

Calibration

Accuracy is specified for a period of one year after calibration. Periodic calibration at intervals of one year is recommended to maintain meter accuracy.

Cleaning and Storage

Periodically wipe the meter and the test probe assembly with a damp cloth and mild detergent. Do not use abrasives or solvents. Allow to dry completely before operating. If the meter is not to be used for periods of longer than 60 days, remove the battery and store it separately

Trouble Shooting

If the instrument fails to operate, check battery, fuses, leads, etc., and replace as necessary. Double check operating procedure as described in this user's manual. Refer to the LIMITED WARRANTY section for obtaining warranty or repairing service.

Battery and Fuse replacement

Battery use: Four 1.5V AA alkaline batteries (IEC LR6)

Fuses use:

Fuse (F2) for $\mu\text{A}/\text{mA}$ input:

0.4A/1000Vac & Vdc, IR 30kA, F fuse; or better. Dimension: 6 x 32 mm

Fuse (F3) for A input:

11A/1000Vac & Vdc, IR 20kA, F fuse; or better. Dimension: 10 x 38 mm

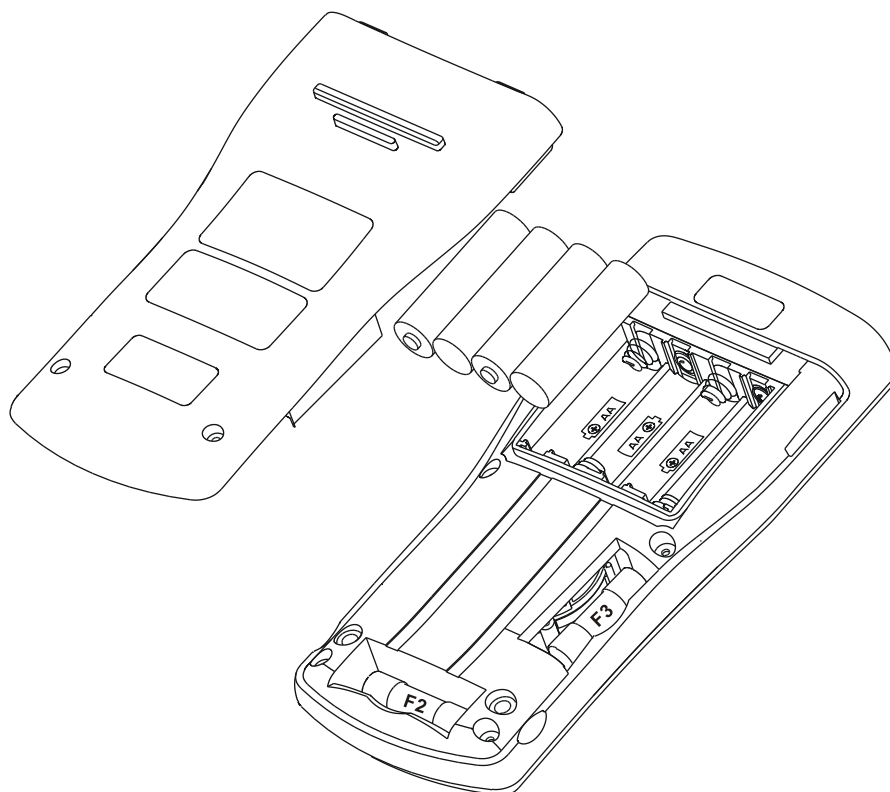

Battery and Fuse replacement:

Loosen the screws from the access cover of the case bottom. Lift the access cover. Replace the batteries or fuse. Re-fasten the screws.

GENERAL SPECIFICATION

Display: 3-5/6 digits 6,000 counts & 4-1/2 digits 20,000 counts max

Polarity: Automatic

3-5/6 digits Update Rate: 5 per second nominal

4-1/2 digits Update Rate: 5 per second nominal

61 Segments Bar graph Update Rate: 40 per second max

Operating Temperature: -10°C to 50°C

Relative Humidity: Maximum relative humidity 90% for temperature up to 28°C decreasing linearly to 50% relative humidity at 50°C

Pollution Degree: 2

IP Rating: IP40

Storage Temperature: -20°C to 60°C, < 80% R.H. (with battery removed)

Altitude: Operating below 2000m

Temperature Coefficient: nominal 0.1 x (specified accuracy)/ °C @(-10°C ~ 18°C or 28°C ~ 50°C), or otherwise specified

Sensing: AC True RMS

Safety: ETL certified per IEC/UL/EN61010-1 Ed. 3.0, IEC/UL/EN61010-2-030 Ed. 1.0, IEC/UL/EN61010-2-033 Ed. 1.0, IEC/UL/EN61010-031 Ed. 1.1 and the corresponding CAN/CSA-C22.2 regulations to Measurement Categories:

CAT III 1000 V AC & DC and Category IV 600V AC & DC

Overload Protections:

μA & mA: 0.4A/1kV DC/AC rms, IR 30kA, F Fuse; or better

A: 11A/1kV DC/AC rms, IR 20kA, F Fuse; or better

V: 1100V DC/AC rms

mV, Ω & Others: 1000 V DC/AC rms

Transient Protection: 8kV (1.2/50μs surge)

E.M.C.: Meets EN61326-1:2013

ACV of Model 836, in an RF field of 1V/m:

Total Accuracy = Specified Accuracy + 30 digits

Performance above 1V/m is not specified

All Other Functions, in an RF field of 3V/m:

Total Accuracy = Specified Accuracy + 150 digits

Performance above 3V/m is not specified

Power Supply: Four Alkaline AA batteries (IEC LR6)

Power Consumption: 8mA typical for VFD ACV^{+Hz}; 6.5mA typical for other functions

Low Battery: approx. 4.6V

APO Timing: Idle for 20 minutes

APO Consumption: 20 μ A typical

Dimension: L208mm X W103mm X H64.5mm with holster

Weight: 635 gm with holster

Accessories: Test probe pair, Holster, User's manual, Bkp60 banana plug type-K thermocouple (Model 839 only)

Optional Accessories: BKB32 banana plug to type-K socket plug adaptor (Model 839 only), BMH-01 magnetic hanger; BMP-86x soft carrying pouch

Special Features: VFD; Dual display +Hz Readings; Selectable 6,000 & 20,000 Counts Resolution; High-Update Record MAX/MIN readings; Crest MAX/MIN readings; Relative Zero; Display Hold; LCD Backlight; BeepLit™ Continuity Tester, BeepJack™ audible & visible input warning

Electrical Specifications

Accuracy is \pm (% reading digits + number of digits) or otherwise specified, at 23°C \pm 5°C & less than 80% relative humidity.

True RMS voltage & current accuracies are specified from 1% to 100% of range or otherwise specified. Maximum Crest Factor < 1.8:1 at full scale & < 3.6:1 at half scale, and with frequency components fall within the specified frequency bandwidth for non-sinusoidal waveforms.

AC Voltage (6000-count mode)

RANGE	Accuracy	
	Model 839	Model 836
50Hz ~ 60Hz		
600.0mV ⁴⁾ , 6.000V, 60.00V, 600.0V, 1000V	0.7% + 3d	0.5% + 3d
40Hz ~ 1kHz		
600.0mV ⁴⁾ , 6.000V, 60.00V, 600.0V	1 % + 3d	
1000V ⁵⁾	2 % + 3d	
1kHz ~ 5kHz		
600.0mV ⁴⁾ , 6.000V, 60.00V, 600.0V	1.8% + 4d ²⁾	2% + 40d ¹⁾
1000V	Unspecified	
5kHz ~ 20kHz³⁾		
600.0mV ⁴⁾	2.5% + 20d ²⁾	Unspecified
6.000V, 60.00V	2% + 20d ²⁾	Unspecified
600.0V, 1000V	Unspecified	

Input impedance: 10M Ω , 110pF nominal

¹⁾Add 1% @ bandwidth >4kHz ~ 5kHz

2)Add 20d @ reading >80% of range

3)Unspecified for readings < 5% of range

4)Signal peak absolute values, including DC bias, less than 1100mV_{peak}

5)40Hz ~ 500Hz only for model 836

AC Voltage (20000-count mode)

RANGE	Accuracy	
	Model 839	Model 836
50Hz ~ 60Hz		
199.99mV ³⁾ , 1.9999V, 19.999V, 199.99V, 1000.0V	0.7% + 30d	0.5% + 30d
40Hz ~ 1kHz		
199.99mV ³⁾ , 1.9999V, 19.999V, 199.99V	1 % + 30d	
1000.0V ⁴⁾	2 % + 30d	
1kHz ~ 5kHz		
199.99mV ³⁾ , 1.9999V, 19.999V, 199.99V	1.8% + 40d	2% + 40d ¹⁾
1000.0V	Unspecified	
5kHz ~ 20kHz²⁾		
199.99mV ³⁾ , 1.9999V, 19.999V, 199.99V	2% + 40d	Unspecified
1000.0V	Unspecified	

Input impedance: 10MΩ, 110pF nominal

1)Add 1% @ bandwidth >4kHz ~ 5kHz

2)Unspecified for readings < 5% of range

3)Signal peak absolute values, including DC bias, less than 1100mV_{peak}

4)40Hz ~ 500Hz only for model 836

VFD AC Voltage

RANGE	Accuracy ¹⁾
10Hz ~ 45Hz	
600.0V, 1000V	4% + 5d
45Hz ~ 200Hz	
600.0V, 1000V	2.5% + 5d
200Hz ~ 440Hz	
600.0V, 1000V	9% + 5d ²⁾

Input impedance: 10MΩ, 110pF nominal

1)Unspecified for fundamental frequency > 440Hz

2)Accuracy linearly decreases from 2.5% + 5d @200Hz to 9.0% + 5d @440Hz

DC Voltage (6000-count mode)

RANGE	Accuracy	
	Model 839	Model 836
600.0mV	0.09% + 1d	0.18% + 1d
6.000V, 60.00V	0.045% + 1d	0.09% + 1d
600.0V, 1000V	0.09% + 1d	0.18% + 1d

Input impedance: 10M Ω , 110pF nominal

DC Voltage (20000-count mode)

RANGE	Accuracy	
	Model 839	Model 836
199.99mV	0.09% + 6d	0.18% + 6d
1.9999V, 19.999V, 199.99V	0.045% + 6d	0.09% + 6d
1000.0V	0.09% + 6d	0.18% + 6d

Input impedance: 10M Ω , 110pF nominal

Ohms (6000-count mode)

RANGE ¹⁾	Accuracy	
	Model 839	Model 836
600.0 Ω	0.15% + 3d	0.3% + 3d
6.000k Ω , 60.00k Ω	0.15% + 1d	0.3% + 1d
600.0k Ω	0.3% + 1d	0.6% + 1d
6.000M Ω ²⁾	0.5% + 1d	0.7% + 1d
60.00M Ω ³⁾	1.5% + 3d ^{4) 6)}	2% + 3d ^{4) 6)}
60.00nS ³⁾	2.0% + 10d ^{5) 6)}	

¹⁾Open Circuit Voltage: 1.7VDC typical

²⁾Constant Test Current: 0.2 μ A Typical

³⁾Constant Test Current: 0.02 μ A Typical

⁴⁾Add 1% @ >20M Ω

⁵⁾Add 30d @ < 20% of range

⁶⁾Add 2% @ operation temperature >35 $^{\circ}$ C

Ohms (20000-count mode)

RANGE ¹⁾	Accuracy	
	Model 839	Model 836
199.99 Ω ²⁾	0.15% + 20d	0.3% + 20d
1.9999k Ω , 19.999k Ω	0.15% + 6d	0.3% + 6d
199.99k Ω	0.3% + 6d	0.6% + 6d
1.9999M Ω ³⁾	0.5% + 6d	0.7% + 6d
19.999M Ω ⁴⁾	1.5% + 30d ⁵⁾	2% + 30d ⁵⁾

¹⁾Open Circuit Voltage: 1.7VDC typical

²⁾Specified with input lead resistance been offset by **RELA** or **Shrt** (short) feature

³⁾Constant Test Current: 0.2 μ A Typical

⁴⁾Constant Test Current: 0.02 μ A Typical

⁵⁾Add 2% @ operation temperature >35°C

BeepLit™ Continuity Tester

Continuity Threshold: Between 20 Ω and 350 Ω

Response time: < 30ms

Audible Response: Beep sound

Visible Response: LCD Backlight

Diode Tester

Range	Accuracy	Test Current (Typical)	Open Circuit Voltage
2.700V	1.5% + 4d	0.4mA	< 2.8 VDC

Capacitance

RANGE	Accuracy ¹⁾
20.00nF	1% + 8d
200.0nF, 2.000 μ F, 20.00 μ F, 200.0 μ F, 2000 μ F	1% + 2d
20.00mF	2% + 2d

¹⁾Accuracies with film capacitor or better

Temperature (Model 839 only)

RANGE	Accuracy ^{1) 2)}
-40.0°C ~ 0.0°C	1% + 2.0°C
0.0°C ~ 50.0°C	1% + 1.0°C
50.0°C ~ 1090.0°C	1% + 1.5°C
-40.0°F ~ 32.0°F	1% + 3.6°F
32.0°F ~ 122.0°F	1% + 1.8°F
122.0°F ~ 1994.0°F	1% + 2.7°F

¹⁾Accuracies assume meter interior has the same temperature of the ambient (isothermal stage) for a correct junction voltage compensation. Allow enough time to reach the isothermal stage for a significant change of ambient temperature. It can take up to an hour for changes > 5°C.

²⁾Type-K thermocouple range & accuracy not included

DC current (6000-count mode)

RANGE	Accuracy		Burden Voltage
	Model 839	Model 836	
600.0µA ¹⁾	0.18% + 4d	0.36% + 4d	0.2mV/µA
6000µA ¹⁾	0.18% + 2d	0.36% + 2d	0.2mV/µA
60.00mA ¹⁾	0.18% + 4d	0.36% + 4d	3.0mV/mA
600.0mA ^{1) 2)}	0.3% + 3d	0.5% + 3d	3.0mV/mA
6.000A	0.5% + 4d	0.6% + 4d	30mV/A
10.00A ³⁾	0.7% + 2d	0.8% + 2d	30mV/A

¹⁾µA/mA DC accuracies will be affected by extreme interior temperatures of the meter. For rated accuracies, allow 6 to 20 minutes cool down interval after measuring A-currents of 3 to 10A continuously.

²⁾ ●400mA continuous; >400mA for <1.1 hours on per >20 minutes off

³⁾10A continuous up to ambient 35°C; <15 mins on per >5 mins off @ 35°C ~ 50°C. >10A to 20A for <30 seconds on per >5 mins off

DC current (20000-count mode)

RANGE	Accuracy		Burden Voltage
	Model 839	Model 836	
199.99 μ A ¹⁾	0.18% + 40d	0.36% + 40d	0.2mV/ μ A
1999.9 μ A ¹⁾	0.18% + 20d	0.36% + 20d	0.2mV/ μ A
19.999mA ¹⁾	0.18% + 40d	0.36% + 40d	3.0mV/mA
199.99mA ¹⁾	0.18% + 30d	0.36% + 30d	3.0mV/mA
1.9999A	0.5% + 40d	0.6% + 40d	30mV/A
10.000A ²⁾	0.7% + 20d	0.8% + 20d	30mV/A

¹⁾ μ A/mA DC accuracies will be affected by extreme interior temperatures of the meter. For rated accuracies, allow 6 to 20 minutes cool down interval after measuring A-currents of 3 to 10A continuously.

²⁾10A continuous up to ambient 35°C; <15 mins on per >5 mins off @ 35°C ~ 50°C. >10A to 20A for <30 seconds on per >5 mins off

AC current (6000-count mode)

RANGE	Accuracy		Burden Voltage
	Model 839	Model 836	
40Hz ~ 3kHz			
600.0 μ A, 6000 μ A	1% + 2d	1.2% + 2d	0.2mV/ μ A
60.00mA, 600.0mA ¹⁾			3mV/mA
6.000A, 10.00A ²⁾	1% + 4d	1.2% + 4d	30mV/A
3kHz ~ 5kHz			
600.0 μ A, 6000 μ A	2% + 2d	Unspecified	0.2mV/ μ A
60.00mA, 600.0mA ¹⁾			3mV/mA
6.000A, 10.00A ²⁾	Unspecified		30mV/A

¹⁾ ●400mA continuous; >400mA for <1.1 hours on per >20 minutes off

²⁾10A continuous up to ambient 35°C; <15 mins on per >5 mins off @ 35°C ~ 50°C. >10A to 20A for <30 seconds on per >5 mins off

AC current (20000-count mode)

RANGE	Accuracy		Burden Voltage
	Model 839	Model 836	
40Hz ~ 3kHz			
199.99 μ A, 1999.9 μ A	1% + 20d	1.2% + 20d	0.2mV/ μ A
19.999mA, 199.99mA			3mV/mA
1.9999A, 10.000A ¹⁾	1% + 40d	1.2% + 40d	30mV/A
3kHz ~ 5kHz			
199.99 μ A, 1999.9 μ A	2% + 20d	Unspecified	0.2mV/ μ A
19.999mA, 199.99mA			3mV/mA
1.9999A, 10.000A ¹⁾	Unspecified		30mV/A

¹⁾10A continuous up to ambient 35°C; <15 mins on per >5 mins off @ 35°C ~ 50°C.
>10A to 20A for <30 seconds on per >5 mins off

~ Hz Line Level Frequency

Function RANGE	Sensitivity (Sine RMS)	Range
199.99mV, 600.0mV	40mV	6Hz ~ 100kHz
1.9999V, 6.000V	0.4V	10Hz ~ 50kHz
19.999V, 60.00V	4V	
199.99V, 600.0V	40V	10Hz ~ 30kHz
1000.0V, 1000V	400V	10Hz ~ 5kHz
VFD 600.0V	40V	10Hz ~ 440Hz
VFD 1000V	400V	10Hz ~ 440Hz
199.99 μ A, 600.0 μ A	40 μ A	10Hz ~ 5kHz
1999.9 μ A, 6000 μ A	400 μ A	
19.999mA, 60.00mA	4mA	
199.99mA, 600.0mA	40mA	
1.9999A, 6.000A	0.6A	10Hz ~ 3kHz
10.000A, 10.000A	6A	

Accuracy: 0.01%+4d

High-Update Record mode

DC functions update interval 100ms, nominal response to 85%;

For changes > 200ms in duration:

6000-count mode: Specified accuracy ± 12 counts

20000-count mode: Specified accuracy ± 120 counts

AC functions update interval 120ms, nominal response to 85%;

For changes > 350ms in duration and input >5% of range:

6000-count mode: Specified accuracy ± 30 counts

20000-count mode: Specified accuracy ± 300 counts

Crest mode

DC/AC functions

For changes > 5ms in duration:

6000-count mode only: Specified accuracy ± 150 counts

LIMITED WARRANTY

BRYMEN warrants to the original product purchaser that each product it manufactures will be free from defects in material and workmanship under normal use and service within a period of one year from the date of purchase. BRYMEN's warranty does not apply to accessories, fuses, fusible resistors, spark gaps, varistors, batteries or any product which, in BRYMEN's opinion, has been misused, altered, neglected, or damaged by accident or abnormal conditions of operation or handling.

To obtain warranty service, contact your nearest BRYMEN authorized agent or send the product, with proof of purchase and description of the difficulty, postage and insurance prepaid, to BRYMEN TECHNOLOGY CORPORATION. BRYMEN assumes no risk for damage in transit. BRYMEN will, at its option, repair or replace the defective product free of charge. However, if BRYMEN determines that the failure was caused by misused, altered, neglected, or damaged by accident or abnormal conditions of operation or handling, you will be billed for the repair.

THIS WARRANTY IS EXCLUSIVE AND IS IN LIEU OF ALL OTHER WARRANTIES, EXPRESSED OR IMPLIED, INCLUDING BUT NOT LIMITED TO ANY IMPLIED WARRANTY OR MERCHANTABILITY OR FITNESS FOR A PARTICULAR PURPOSE OR USE. BRYMEN WILL NOT BE LIABLE FOR ANY SPECIAL, INDIRECT, INCIDENTAL OR CONSEQUENTIAL DAMAGES.

