

USER'S MANUAL



BT-75EU, BT-73EU, BT-71EU Voltage Tester

1) SAFETY

This manual contains information and warnings that must be followed for operating the tester safely and maintaining the meter in a safe operating condition. If the tester is used in a manner not specified by the manufacturer, the protection provided by the tester may be impaired. The tester is designed to be used by skilled persons and in accordance with safe methods of work.

Terms in this manual

WARNING identifies conditions and actions that could result in serious injury or even death to the user.

CAUTION identifies conditions and actions that could cause damage or malfunction in the instrument.

WARNING

Observe proper safety precautions when working with voltages above 30 Vrms, 42.4 Vpeak or 60 VDC. These voltage levels pose a potential shock hazard to the user. Before and after hazardous voltage measurements, check the voltage function on a known source such as line voltage to determine proper tester functioning.

This CE version tester **meets EN61243-3:2014**, IEC/EN61010-1 Ed. 3.0, IEC/EN61010-2-033 Ed. 1.0 to Measurement CAT-III 1kV and CAT-IV 600V, AC & DC. It also meets water and dust protection IP65 per outdoor type requirements of IEC61243-3:2014. It is, however, not intended to be used in wet locations!

Test probe assembly of this version is subjected to IEC61243-3:2014 regulation that implements <19mm limitations on exposed conductive test tip length for effective contacts on most IP2X designed low voltage boards and panels in CAT III and IV areas. The retractable shroud test tip option further provides IP2X degree of protection, when it is not in use, especially for tester version with RCD Leakage-Path feature.









Keep your hands/fingers behind the hand/finger barriers (of the tester and the test probe assembly, where applicable) that indicate the limits of safe access of the hand-held parts during measurements. Inspect lead wires, connectors, and probes for damaged insulation or exposed metal before using the tester. If any defects are found, replace them immediately. Only use the probe assembly provided with the tester or a Probe Assembly to the same tester ratings or better.

The voltages marked on the tester are nominal voltages or nominal voltage ranges. The tester shall only be used on installations with the specified nominal voltages or nominal voltage ranges. The different indicating signals of the voltage detector (including the ELV limit indication) are not to be used for measuring purposes.

CAUTION

Disconnect the test leads from the test points before changing functions.

International Electrical Symbols

	Marking of Electrical and Electronic Equipment (EEE). Do not dispose of this product as unsorted municipal waste. Contact a qualified recycler
	Caution! Refer to the explanation in this Manual
	Caution! Possibility of electric shock
	Earth (Ground)
	Meter protected throughout by Double Insulation or Reinforced insulation
	Fuse
	Direct Current (DC)
	Alternating Current (AC)
	Three-phase Alternating Current

Brief Information about Measurement Categories

Measurement Category IV is applicable to test and measuring circuits connected at the source of the building's low-voltage MAINS installation. Examples are measurements on devices installed before the main fuse or circuit breaker in the building installation.

Measurement Category III is applicable to test and measuring circuits connected to the distribution part of the building's low-voltage MAINS installation. Examples are measurements on distribution boards (including secondary meters), circuit-breakers, wiring, including cables, bus-bars, junction boxes, switches, socket-outlets in the fixed installation, and equipment for industrial use and some other equipment such as stationary motors with permanent connection to the fixed installation.

Measurement Category II is applicable to test and measuring circuits connected directly to utilization points (socket outlets and similar points) of the low-voltage MAINS installation. Examples are measurements on MAINS CIRCUITS of household appliances, portable tools and similar equipment.

“SAFETY ADVICES

Depending on the internal impedance of the *voltage detector* there will be a different capability of indicating the presence or absence of operating voltage in case of the presence of *interference voltage*.

A *voltage detector* of relatively low internal impedance, compared to the reference value of 100 k Ω , will not indicate all *interference voltages* having an original voltage value above the ELV level. When in contact with the parts to be tested, the *voltage detector* may discharge temporarily the *interference voltage* to a level below the ELV, but it will be back to the original value when the *voltage detector* is removed.

When the indication “voltage present” does not appear, it is highly recommended installing earthing equipment before work.

A *voltage detector* of relatively high internal impedance, compared to the reference value of 100 k Ω , may not permit to clearly indicate the absence of operating voltage in case of presence of *interference voltage*.

When the indication “voltage present” appears on a part that is expected to be disconnected of the installation, it is highly recommended confirming by another means (e.g. use of an adequate *voltage*

detector, visual check of the disconnecting point of the electric circuit, etc.) that there is no operating voltage on the part to be tested and to conclude that the voltage indicated by the *voltage detector* is an *interference voltage*.

A *voltage detector* declaring two values of internal impedance has passed a performance test of managing *interference voltages* and is (within technical limits) able to distinguish operating voltage from *interference voltage* and has a means to directly or indirectly indicate which type of voltage is present.”

2) CENELEC DIRECTIVES

The instruments conform to CENELEC Low-voltage directive 2014/35/EC, Electromagnetic compatibility directive 2014/30/EU and RoHS directive 2011/65/EU.

3) PRODUCT DESCRIPTION

Note: Top-of-the-line model is used as representative for illustration purposes. Please refer to your respective model for function availability.

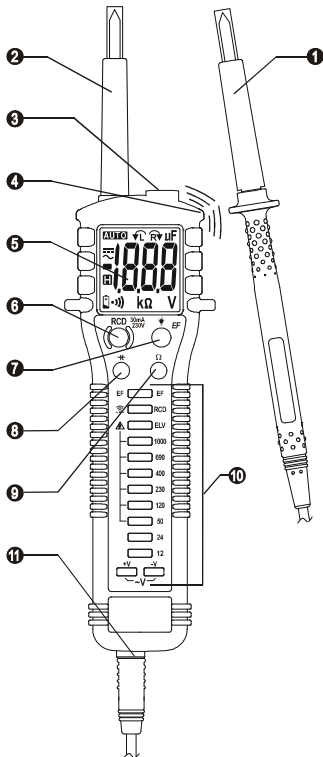

- 1) Detachable Black test probe (-) for all functions (Common ground reference)
- 2) Screw-on stationary Red test probe (+) for all functions
- 3) Flashlight (Model 75 & 73 only)
- 4) EF-Detection (Non-Contact Voltage) antenna area
- 5) **3-1/2 digits 1999 counts** LCD display (Model 75 & 73 only)
- 6) RCD Leakage-Path button (Model 75 & 73 only)
- 7) Power-on/ Backlight+Flashlight toggle (momentary press, Models 75 & 73 only) & EF-Detection (press-and-hold) button
- 8) Power-on/ Capacitance function button (Model 75 only)
- 9) Power-on/ Resistance function button (Model 75 only)
- 10) LED indication
- 11) Input Jack (-) for Detachable Black test probe (Common ground reference)

4) OPERATION

NOTE All function operations described hereafter are via the stationary “Red” probe for positive (+) polarity and the detachable “Black” probe for Ground reference (-), or otherwise specified

WARNING

● *Battery-operated functions and features work only with appropriate internal battery supply, and will not turn on when there is no battery power. Briefly, they are: LCD indication, RCD Leakage-Path, RST Phase Rotation Detection, Electric Field EF-Detection, AC-Detection Shaker, Audible Continuity, Resistance, Capacitance, Backlight & Flashlight etc.*

● *Accurate indication is assured only when use within the specified operating temperature range.*

● *Before using the audible beep sound of Continuity, EF-Detection & RCD etc. at locations with a high background noise level, it shall be determined whether the audible signal is perceptible. The audible beep sound is for information only; do not rely on it, especially in high background noise.*

● *The functioning of the tester shall be checked shortly before and after a test. If indication of one or more steps fails, or if no functioning is indicated, the tester shall no longer be used.*

ACV (√) and DCV (∇) Operating Voltage Indication

As illustrated, connect test probes to voltage source and observe indication. Do not cover the indicating LEDs (and also the LCDs on Models 75 & 73) and do not touch the contact electrode during use. The tester turns on automatically at threshold voltages as specified in the specification section.

●LED Successive Indication, Battery-less

When significant operating ACV is being detected, √ LEDs (+∇ LED & -∇ LED) turn on. When significant operating DCV is being detected, +∇ LED turns on for correct test probes polarity, and -∇ LED turns on for reversed polarity. Operating voltage levels are indicated as a series of LEDs in a successive indication manner. These indicating LEDs actually get power from the system under test without the need of internal battery supply (battery-less).

●LCD Numeric Indication (Models 75 & 73 only), Battery operated

Models 75 & 73 further equip with a battery-operated LCD numeric display for complementary operating voltage indication.

WARNING Test the tester on a known functioning circuit or component shortly before and after use to verify tester functioning.

ELV (Extra Low Voltage) Limit Indication, Battery-less

When an operating voltage above the ELV limit (50Vac and/or 120Vdc) is being detected, the ELV-LED turns on. The indicating LED gets power from the system under test without the need of internal battery supply (battery-less).

WARNING This feature is to warn the user of the presence of a voltage above the ELV limit, not for its evaluation.

RCD (Residual Current Devices) Leakage-Path (Models 75 & 73 only), Battery-operated

As illustrated, connect the tester to the receptacle under test by measuring the voltage across L and PE (live conductor and a protective earth ground). The tester should indicate proper line voltage level.

● RCD Leakage-Path activation is inhibited at <201V or >264V to avoid misuse.

● With proper line voltage level indicating, press momentarily the RCD button to activate. The tester gives flashing RCD-LED accompanied with beep sound as warning during activation. Each activation interval is

automatically limited to 5 seconds maximum.

- If the RCD circuit breaker trips (line voltage is cut off), the flashing RCD-LED as well as the voltage indication should turn off.

- If the RCD circuit breaker does not trip (line voltage is still on) within a reasonable short period of time (mostly a fraction of a second), the breaker is either not working properly or there is a wiring problem.

WARNING When activated, the tester actually connects to a low impedance load of nominal $6.1\text{k}\Omega$ to draw a leakage current of $\approx 30\text{mA}$ typical at 230VAC to trip RCD circuit breakers. In the event of a full continuous 5 second activation interval, the protection PTC will heat up and affect the load current magnitude thereafter. Allow cooling for 120 seconds before the next activation then.

NOTE This function is not intended to identify the effectiveness (trip current and trip time etc as specified by the breaker manufacturers) of breakers. Effectiveness of RCD circuit breakers should be checked by RCD testing, measuring or monitoring equipment under the scope of IEC61557-1 & IEC61557-6.

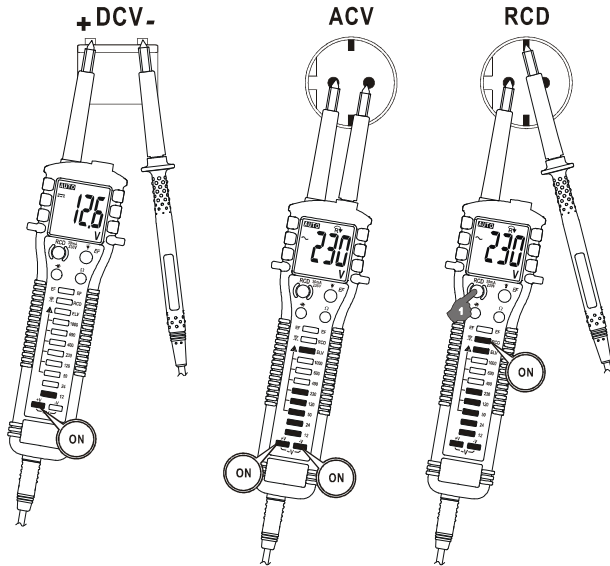

RST Phase Rotation Detection (Models 75 & 73 only), Battery-operated

As illustrated, connect test probes to voltage source and observe indication. The tester should indicate proper operating voltage level for good connections. The Black probe (**L1**) connection is always considered as the Reference-Phase* **R**.

● If annunciator \overrightarrow{RV} turns on, it indicates that a "Right" phase-rotation is being detected. The Red probe (**L2**) connection is then the 2nd Phase **S**. The remaining unconnected connection is the 3rd Phase **T**. Swap the two probe connections to get reversed annunciator \overleftarrow{VL} , as for proper functioning verification.

● If, however, annunciator \overleftarrow{VL} turns on, it indicates that a "Left" phase-rotation is being detected. The Red probe (**L2**) connection is then the 3rd Phase **T**. The remaining unconnected connection is the 2nd Phase **S**. Swap the two probe connections to get reversed annunciator \overrightarrow{RV} , as for proper functioning verification.

NOTE This function works only on Y-connection 3P4W systems. It does not work on Δ -connection 3P3W systems that do not have an earth-ground neutral. It, however, can work on High-leg Δ -connection 3P3W systems by using the high-leg as the Reference-Phase **R** for Black probe (**L1**) connections. That is, simply test and find out the high-leg which has the highest voltage ($\times 3$ times to that of the other legs) with respect to earth-ground, and use it as the Reference-Phase **R** for Black probe (**L1**) connections. High-leg Δ -connection systems have a center-tapped neutral connected to earth-ground.

WARNING It is important to swap the tester probe connections to get reversed annunciator indication for proper functioning verification.

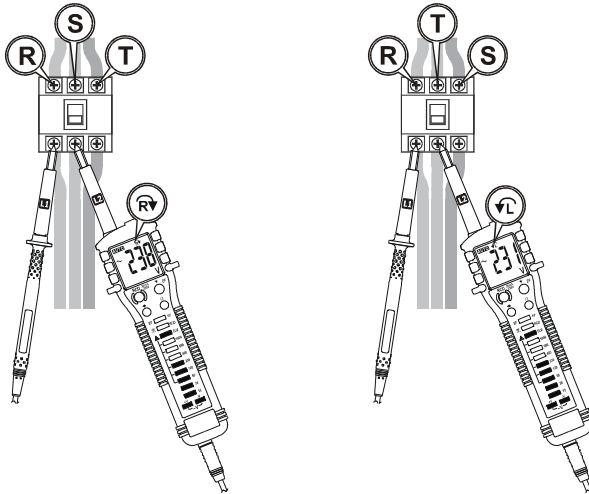

AC-Detection Shaker (Models 75 & 73 only), Battery-operated

The shaker turns on when significant ACV is being detected via the test probes.

Electric Field EF-Detection, Battery-operated

As illustrated, press-and-hold the **EF** button to enter and remain at EF-Detection feature. The EF-LED turns on. Signal strength is indicated by the flashing rate of . Continuity-LED accompanied with beep sound. Models 75 & 73 further display "EF" when they are ready, and display signal strength as successive bar-graph segments on the LCD.

● **Non-Contact EF-Detection:** An antenna is located along the top-right side of the tester, which detects electric field surrounds conductors. It is ideal for tracing live wiring connections, locating wiring breakage and to distinguish between live or earth connections.

● **Probe-Contact EF-Detection:** For more precise indication of live wires, such as distinguishing between live and ground connections, use the Black (-) test probe for direct contact detection.

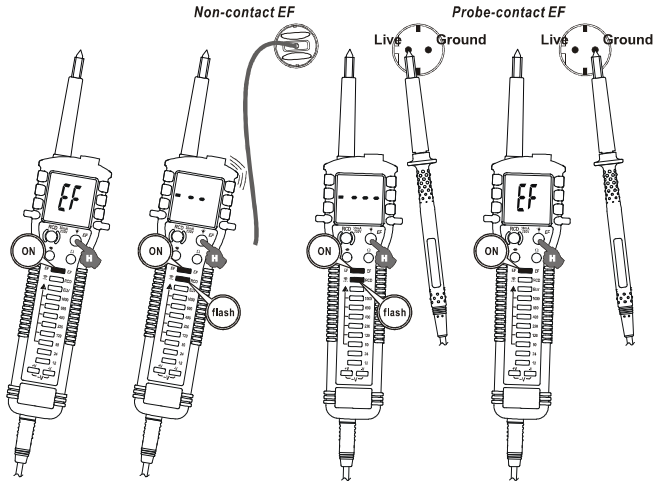

Audible Continuity Function, Battery-operated

Short the two test probes together for quick power-on and continuity function verification. As illustrated, the Continuity-LED turns on accompanied with a continuous beep sound indicate a complete circuit. During power-on, Model 75 & 73 LCD further display “_ _ _” for open circuits and “_ _ _” & “_ _ _)” for complete circuits. Audible-Continuity is convenient for checking wiring connections and operation of switches.

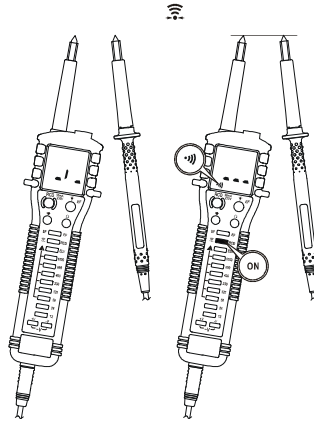

Backlight & Flashlight (Models 75 & 73 only), Battery-operated

Press  button momentarily to toggle on/off the backlight & flashlight.

Resistance Function (Model 75 only), Battery-operated

As illustrated, press-and-hold the Ω button for 1 second to enter the Resistance function directly from power-off. Press Ω button momentarily to toggle between Continuity function during power-on. The resistance value is displayed on the LCD in auto-ranging mode.

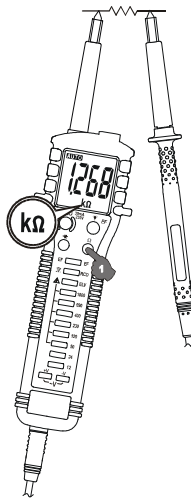

Capacitance Function (Model 75 only), Battery-operated

As illustrated, press-and-hold the $\rightarrow \leftarrow$ button for 1 second to enter the Capacitance function directly from power-off. Press $\rightarrow \leftarrow$ button momentarily to toggle between Continuity function during power-on. The Capacitance value is displayed on the LCD in auto-ranging mode.

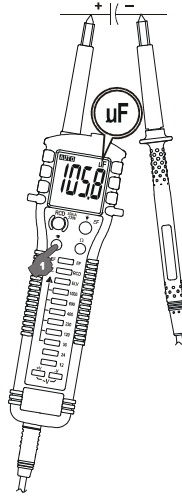

Power On/ Off for Battery-Operated Functions and Features

The battery-operated portion of the tester turns on automatically when the two test probes are shorted together, or significant operating voltage level is detected. See specifications for power-on threshold details. Where available, momentary press the Resistance, Capacitance or Backlight button can also manually turn on the tester. The tester turns off automatically after no further significant testing or push-button activities for approximately 8 seconds for Resistance & Capacitance functions or 16 seconds for others.

5) MAINTENANCE

WARNING

To avoid electrical shock, disconnect the tester from any circuit and remove the detachable test probe from the input jack before opening the case and/or the battery access door. Do not use the tester with open case and/or the battery access door. Do not attempt to repair this unit. It contains no user-serviceable parts. Unauthorized persons shall not disassemble the tester.

Cleaning and Storage

Periodically wipe the case with a damp cloth and mild detergent; do not use abrasives or solvents. The tester should be kept dry and clean. If the tester is not to be used for periods of longer than 60 days, remove the batteries and store them separately

Trouble Shooting

If the tester fails to operate, check batteries, probes, etc., and replace as necessary. Double check operating procedure as described in this user's manual

If the tester voltage-continuity input has subjected to high voltage transient (mostly caused by lightning or switching surge to your system) by accident or abnormal conditions of operation, the series protective impedance could become high impedance like fuses to protect the user and the tester. Most measuring functions through this input will then be open circuit. The protective impedance should then be replaced by qualified technician. Refer to the LIMITED WARRANTY section for obtaining warranty or repairing service.

Low-battery indication

For Models 75 & 73, the LCD annunciator  turns on to indicate low-battery.

For Model 71, EF and Continuity LEDs flashing simultaneously to indicate low-battery.

WARNING Always power-on the tester and check for low-battery status before using battery-operated functions. Replace low-batteries ASAP to maintain tester accuracy and functionality.

Battery replacement

Loosen the 2 screws from the battery access door of the case bottom. Lift the battery access door up. Replace the batteries. Re-fasten the screws.

The tester uses 1.5V AAA Size (NEDA 24A or IEC LR03) alkaline battery X 2.

6) SPECIFICATION

GENERAL SPECIFICATIONS

LCD Display (Models 75 & 73 only): 1999 counts

Display Update Rate (Models 75 & 73 only): 5 per second nominal

Operating Temperature: -10°C ~ 50°C

Relative Humidity: ●90%

Altitude: Operating below 2000m

Storage Temperature: -20°C ~ 65°C, ●80% R.H. (with battery removed)

Temperature Coefficient: Nominal 0.15 x (specified accuracy)/ °C @ (-10°C ~ 18°C or 28°C ~ 50°C), or otherwise specified

Sensing: TRMS sensing for LCD indication; Averaging sensing for LED indication

Measurement Category: CAT III 1000V & CAT IV 600V AC & DC

E.M.C.: Meets EN61326-1:2013

For LCD display only:

Total accuracy = Specified accuracy + 45d @ an RF Field of 3V/m.

Type of Protection: IP65 (Certified by SGS UK)

Pollution Degree: 2

Safety: Meets IEC/EN61010-1 Ed. 3.0, IEC/EN61010-2-033 Ed. 1.0, IEC/EN61243-3:2014 to CAT III 1000V & CAT IV 600V

Transient Protection: 8kV lightning surge (1.2/50µs)

Overload Protection: 1100VDC & VAC rms

Low Battery: Below approx. 2.6V

Power Supply: 1.5V AAA Size (NEDA 24A or IEC LR03) alkaline battery X 2

APO Timing:

Resistance and Capacitance functions: Idle for 8 seconds

Other functions: Idle for 16 seconds

Battery Power Consumption (typical):

Model 71:

1mA for Power-on ready

40mA for Buzzer on @ Continuity or EF function

Model 75 & 73:

2.7mA for Power-on ready & DCV

50mA for ACV (with shaker on)

105mA for RCD

40mA for Buzzer on @ Continuity or EF function

55mA for Resistance or Capacitance

Add 30mA for Backlight on

APO Consumption (typical): 12µA for Models 75 & 73; 6µA for Model 71

Dimension: L278mm x W57mm x H40mm

Weight: Approx. 235gm

Special Features: EF-Detection; LCD indication (Models 75 & 73 only), AC-Detection Shaker (Models 75 & 73 only); RCD Leakage-Path (Models 75 & 73 only); RST Phase Rotation Detection (Models 75 & 73 only); Resistance and Capacitance functions (Model 75 only)

Accessories: Batteries, User's manual, Screw-on stationary red probe and detachable leaded black

probe

Electrical Specification

Accuracy is given as \pm (% of reading digits + number of digits) or otherwise specified @ 23°C \pm 5°C.
 Maximum Crest Factor <2:1 at full scale & <4:1 at half scale, and with frequency components fall within the tester specified frequency bandwidth for non-sinusoidal waveforms

DC & AC Operating Voltage, LED Successive Indication

Voltage Marking	Typical Turn-ON Threshold (% of Voltage Marking)	Typical Turn-OFF Threshold (% of Pre-Voltage Marking)
12V	9.6V (80%)	7V
24V	19.2V (80%)	14V (116%)
50V	40V (80%)	33V (137%)
120V	96V (80%)	67V (134%)
230V	184V (80%)	140V (117%)
400V	320V (80%)	283V (123%)
690V	552V (80%)	490V (122%)
1000V	800V (80%)	760V (110%)

LED Threshold ON: < 85% of Voltage Marking.

LED Threshold OFF: > 110% of Pre-Voltage Marking.

Input Impedance:

12V, 24V, 50V Voltage Markings: 100k Ω , 160pF nominal

120V, 230V, 400V, 690V, 1000V Voltage Markings: 200k Ω ~ 500k Ω vary linearly, 160pF nominal

ACV Frequency Response: 45Hz ~ 65Hz

Duty ratio:

Continuous @ ● 300V

Time rating (t_r) ON for 30 seconds & Recovery time (t_r) OFF for 2 minutes @ > 300V

DC & AC Operating Voltage, LCD Numeric Indication (Models 75 & 73 only)

RANGE	Auto-Power-ON Threshold	Accuracy
DC 199.9V, 1000V	> +27VDC or < -4.5VDC	1.5%+3d
AC 199.9V, 1000V	> 8VAC	2.5%+4d

Input Impedance:

12V, 24V, 50V Voltage Markings: 100k Ω , 160pF nominal

120V, 230V, 400V, 690V, 1000V Voltage Markings: 200k Ω ~ 500k Ω vary linearly, 160pF nominal

ACV Frequency Response: 45Hz ~ 65Hz

Duty ratio:

Continuous @ ● 300V

Time rating (t_r) ON for 30 seconds & Recovery time (t_r) OFF for 2 minutes @ > 300V

AC-Detection Shaker (Models 75 & 73 only)

Shaker Threshold: Between 8V and 15V ac

Audible Continuity

Open Circuit Voltage: 0.7DC typical

Audible Threshold:

Between 500k Ω and 750k Ω for Models 75 & 73

Between 1M Ω and 1.5M Ω for Model 71

Electric Field EF-Detection

Non-Contact EF-Detection: An antenna is located at the top-right side of the tester

Probe-Contact EF-Detection: Via Black (-) test probe for direct-contact detection. It is mainly for identification of live connections using maximum sensitivity.

Detection Frequency: 50/60Hz

Strength Indication: Signal strength is indicated by the flashing rate of  Continuity-LED accompanied with beep sound. Models 75 & 73 also display successive bar-graph segments proportional to the field strength on LCD. Typical Non-Contact EF-Detection values are shown in the following table.

Typical Non-Contact Voltage Range			LCD Bar-Graph Indication
LED Flashing Rate	Model 71	Models 75 & 73	Models 75 & 73
#1	80V to 250V	15V to 55V	-
#2	150V to 450V	30V to 95V	--
#3	300V to 700V	55V to 170V	---
#4	Above 500V	Above 120V	----

RCD Leakage-Path (Models 75 & 73 only)

RCD Circuit Breakers intended: 30mA/230Vac

Activation inhibited: at <201V or >264V

Activation indication: Flashing RCD-LED accompanied with beep sound

Path Impedance: 6.1k Φ nominal, PTC protected

Path Current: \approx 30mA typical at 230V

Activation interval¹⁾: Maximum 5 seconds with automatic cutoff

¹⁾ In the event of a full continuous 5 second activation interval, the protection PTC will heat up and affect the load current magnitude thereafter. Allow cooling for 120 seconds before the next activation then.

RST 3-Phase Rotation Detection (Models 75 & 73 only)

Voltage Range: 165V ~ 1000V

Frequency Range: 45Hz ~ 65Hz

Applications: Intended for Y-connection 3P4W and High-leg Δ -connection 3P3W systems. Not intended for Δ -connection 3P3W systems without an earth-ground neutral.

OHM¹⁾ (Model 75 only)

RANGE	Accuracy
1.999k Ω , 19.99k Ω , 199.9k Ω , 1000k Ω	2.5%+5d

Open Circuit Voltage: 1.0Vdc typical

¹⁾ Resistance function shares the same PTC protection of RCD Leakage-Path function. For specified accuracy, allow cooling for 120 seconds especially right after a full continuous 5 second RCD activation interval.

Capacitance¹⁾ (Model 75 only)

RANGE	Accuracy
199.9 $\text{O}F$ ²⁾	2.5%+5d
1999 $\text{O}F$	5.0%+5d

¹⁾ Capacitance function shares the same PTC protection of RCD Leakage-Path function. For specified accuracy, allow cooling for 120 seconds especially right after a full continuous 5 second RCD activation interval.

²⁾ Specification +10d @<25.0 $\text{O}F$

LIMITED WARRANTY

BRYMEN warrants to the original product purchaser that each product it manufactures will be free from defects in material and workmanship under normal use and service within a period of one year from the date of purchase. BRYMEN's warranty does not apply to accessories, fuses, fusible resistors, spark gaps, varistors, batteries or any product which, in BRYMEN's opinion, has been misused, altered, neglected, or damaged by accident or abnormal conditions of operation or handling.

To obtain warranty service, contact your nearest BRYMEN authorized agent or send the product, with proof of purchase and description of the difficulty, postage and insurance prepaid, to BRYMEN TECHNOLOGY CORPORATION. BRYMEN assumes no risk for damage in transit. BRYMEN will, at its option, repair or replace the defective product free of charge. However, if BRYMEN determines that the failure was caused by misused, altered, neglected, or damaged by accident or abnormal conditions of operation or handling, you will be billed for the repair.

THIS WARRANTY IS EXCLUSIVE AND IS IN LIEU OF ALL OTHER WARRANTIES, EXPRESSED OR IMPLIED, INCLUDING BUT NOT LIMITED TO ANY IMPLIED WARRANTY OR MERCHANTABILITY OR FITNESS FOR A PARTICULAR PURPOSE OR USE. BRYMEN WILL NOT BE LIABLE FOR ANY SPECIAL, INDIRECT, INCIDENTAL OR CONSEQUENTIAL DAMAGES.



BRYMEN TECHNOLOGY CORPORATION

TEL:+886 2 2226 3396

FAX:+886 2 2225 0025

<http://www.brymen.com>



PRINTED ON RECYCLABLE PAPER, PLEASE RECYCLE

COPYRIGHT © MMXVII BTC, ALL RIGHTS RESERVED

P/N: 7M1C-1521-0000

PRINTED IN TAIWAN