

BM157s & BM357s
3-Phase PowerClamp™

USER'S MANUAL



1) SAFETY

This manual contains information and warnings that must be followed for operating the instrument safely and maintaining the instrument in a safe operating condition. If the instrument is used in a manner not specified by the manufacturer, the protection provided by the instrument may be impaired.

The meter protection rating, against the users, is double insulation per IEC/UL/EN61010-1 Ed. 3.0, IEC/EN61010-2-032 Ed. 3.0, IEC/EN61010-2-033 Ed. 1.0, IEC/UL/EN61010-031 Ed. 1.1 & CAN/CSA-C22.2 No. 61010-1-12 Ed. 3.0:

Category CAT III 600V AC & DC.

PER IEC61010 OVERVOLTAGE INSTALLATION CATEGORY

OVERVOLTAGE CATEGORY II

Equipment of OVERVOLTAGE CATEGORY II is energy-consuming equipment to be supplied from the fixed installation.

Note – Examples include household, office, and laboratory appliances.

OVERVOLTAGE CATEGORY III

Equipment of OVERVOLTAGE CATEGORY III is equipment in fixed installations.

Note – Examples include switches in the fixed installation and some equipment for industrial use with permanent connection to the fixed installation.

OVERVOLTAGE CATEGORY IV

Equipment of OVERVOLTAGE CATEGORY IV is for use at the origin of the installation.

Note – Examples include electricity meters and primary over-current protection equipment.

TERMS IN THIS MANUAL

WARNING identifies conditions and actions that could result in serious injury or even death to the user.

CAUTION identifies conditions and actions that could cause damage or malfunction in the instrument.

WARNING

To reduce the risk of fire or electric shock, do not expose this product to rain or moisture. The meter is intended only for indoor use.

To avoid electrical shock hazard, observe the proper safety precautions when working with voltages above 60 VDC or 30 VAC rms. These voltage levels pose a potential shock hazard to the user.









Keep your hands/fingers behind the hand/finger barriers (of the meter and the test leads) that indicate the limits of safe access of the hand-held part during measurement. Inspect test leads, connectors, and probes for damaged insulation or exposed metal before using the instrument. If any defects are found, replace them immediately. **Only use the test lead provided with the equipment or UL Listed Probe Assembly rated CAT III 600V or better.**

This Clamp-on meter is designed to apply around or remove from uninsulated hazardous live conductors. But still, individual protective equipment must be used if hazardous live parts in the installation where measurement is to be carried out could be accessible.

CAUTION

Disconnect the test leads from the test points before changing meter functions.

INTERNATIONAL ELECTRICAL SYMBOLS

	Caution ! Refer to the explanation in this Manual
	Caution ! Risk of electric shock
	Earth (Ground)
	Double Insulation or Reinforced insulation
	Fuse
	AC--Alternating Current
	DC--Direct Current
	Application around and removal from hazardous live conductors is permitted

2) CENELEC Directives

The instruments conform to CENELEC Low-voltage directive 2006/95/EC and Electromagnetic compatibility directive 2004/108/EC

3) PRODUCT DESCRIPTION

Note: Top of the line model is used as representative for illustration purposes. Please refer to your respective model for function availability.

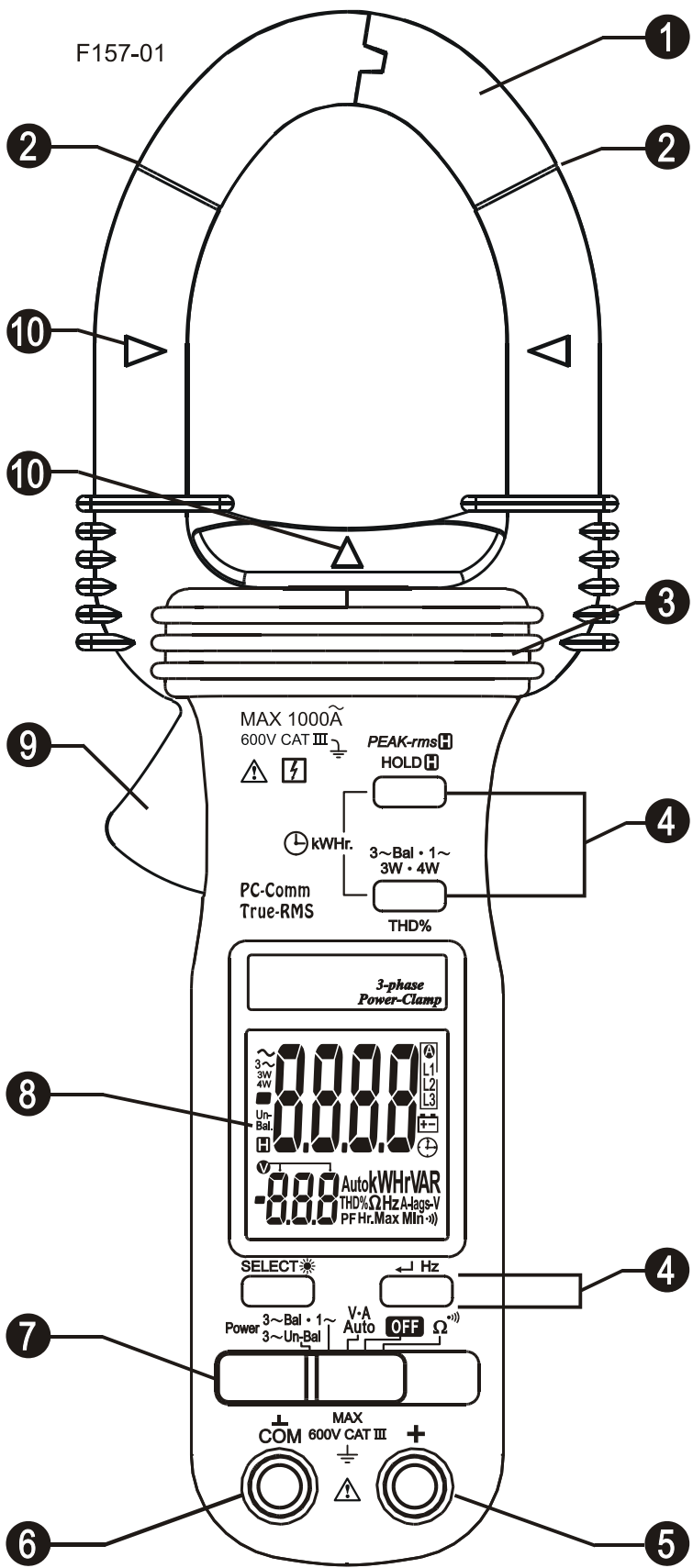

- 1) Transformer Clamp Jaws for AC current magnetic field pick up
- 2) Jaw marking lines for ACA (& thus Power) position error indication
- 3) Hand/Finger Barrier to indicate the limits of safe access to the jaws during current measurements
- 4) Push-buttons for special functions & features
- 5) Input Jack for all functions EXCEPT non-invasive ACA current (& thus Power) function
- 6) Common (Ground reference) Input Jack for all functions EXCEPT non-invasive ACA current (& thus Power) function
- 7) Slide-switch Selector to turn the power ON/OFF and Select a function
- 8) LCD display
- 9) Jaw trigger for opening the transformer clamp jaws
- 10) Jaw center Indicators, at where best ACA (& thus Power) accuracy is specified

4) OPERATION

CAUTION

Before and after hazardous voltage measurements, test the voltage function on a known source such as line voltage to determine proper meter functioning.

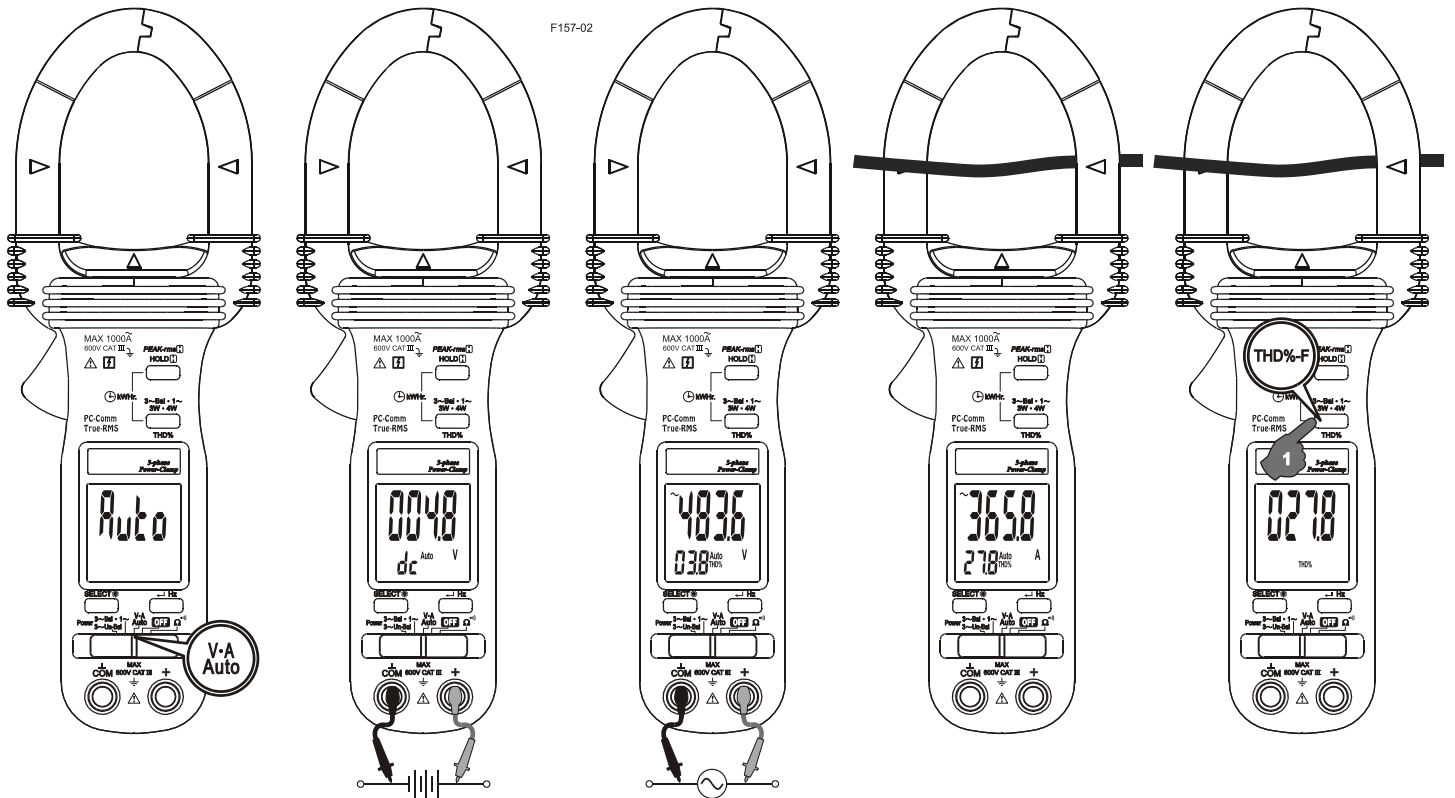

AutoVA™ function

Set the slide-switch function-selector to the **V-A** Auto position.

- With no input, the meter displays “Auto” when it is ready.
- With no ACA current input via the jaws but a voltage signal above the nominal threshold of DC 2.4V or AC 30V (40Hz ~ 500Hz) up to the rated 600V is present on V-COM terminals, the meter displays the voltage value in appropriate DC or AC, whichever larger in peak magnitude. Annunciators “Auto” “dc” and “Auto” “~” turn on respectively.
- On the contrary, with no voltage signal present on V-COM terminals but a ACA current signal above the nominal threshold of AC 1A (40Hz ~ 500Hz) up to the rated 1000A is input via the jaws, the meter displays the ACA current value. Annunciators “~” and “Auto” turn on accordingly.
- The Auto-VA feature stays at the auto-selected function as long as its signal remains above the specified threshold. Press **SELECT** button momentarily to manually select and lock (annunciator “Auto” turns off) thru the functions ACA, ACV, DCV and then goes back to Auto-VA.

CAUTION (*Application and removal of the Clamp-on meter*)

- *For non-invasive ACA current measurements, press the jaw trigger and clamp the jaws around only one single conductor of a circuit for load current measurement. Make sure the jaws are completely closed, or else it will introduce measurement errors. Enclosing more than one conductor of a circuit will result in differential current (like identifying leakage current) measurement. Locate the conductor(s) at the Jaws center as much as possible to get the best measuring accuracy. For removal, press the jaw trigger and remove the jaws from the conductor(s).*
- *Adjacent current-carrying devices such as transformers, motors and conductor wires will affect measurement accuracy. Keep the jaws away from them as much as possible to minimize influence.*

THD%-F Total Harmonic Distortion - Fundamental function (Model 157s only)

Total Harmonic Distortion - Fundamental (THD%-F) function is designed to give basic indication on the presence of Harmonics. It is the percentage ratio of the Total Harmonics RMS value to the Fundamental RMS value of a voltage or current signal, and is given by the expression:

$$\text{THD\%-F} = (\text{Total Harmonics RMS} / \text{Fundamental RMS}) \times 100\%$$



An ideal sinusoidal waveform has a theoretical value of 0 THD%. A badly distorted sinusoidal waveform may have a much higher THD% value of even up to several hundreds. It is thus a good parameter to identify the degree of “cleanness” on power systems.

When the meter is in ACV or ACA function, THD%-F values will be displayed in the secondary mini display automatically. Press **THD%-F** button momentarily toggles THD% readings to main display.

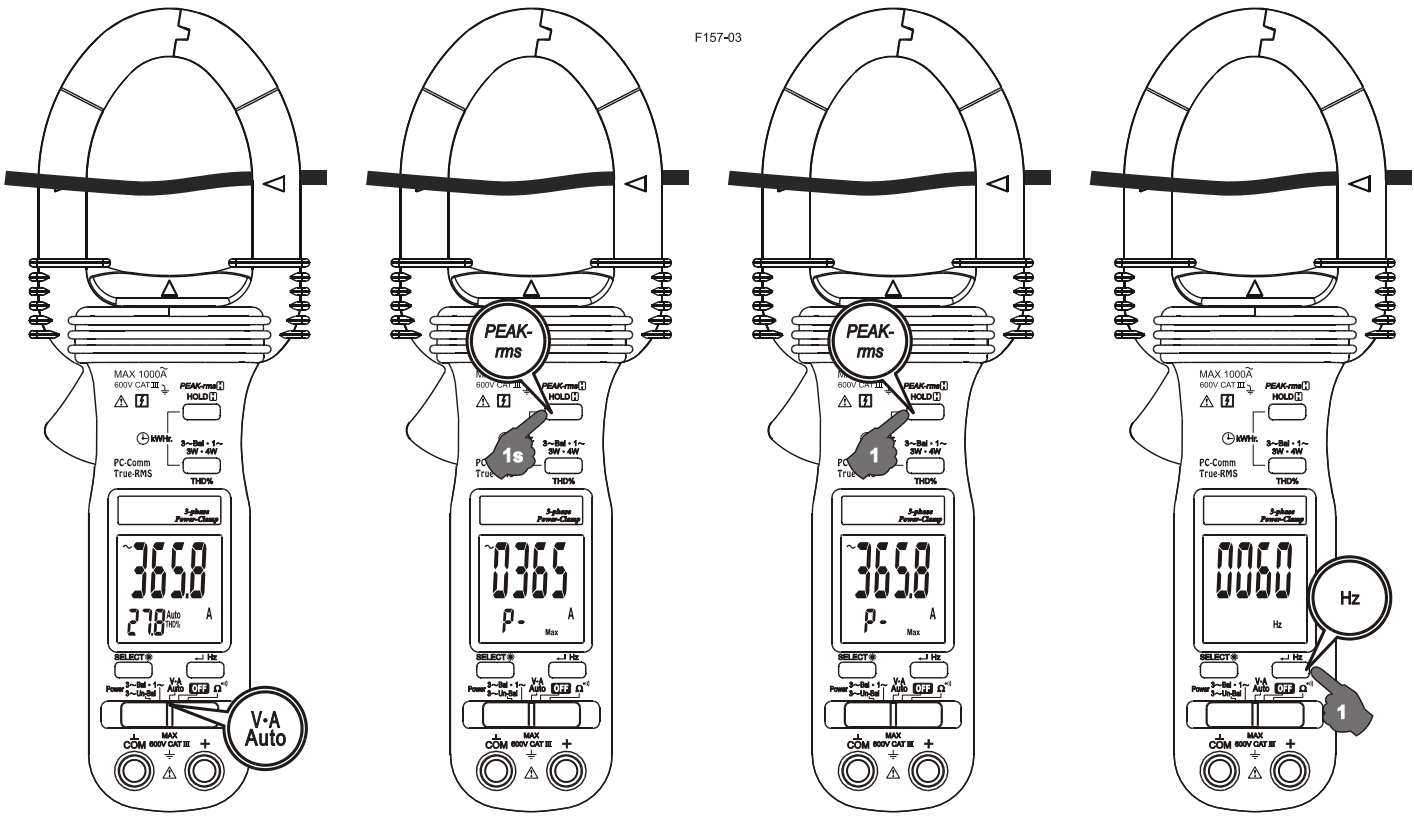
F157-03



Peak-rms mode

Peak-rms  compares and displays the maximum RMS value of surge voltage or current with durations as short as 65ms. When ACV or ACA function is auto-selected or manual-selected, press and hold **Peak-rms**  button for one second or more toggles to this mode. The annunciators “P-” “Max” turn on. APO (Auto Power Off) feature is disabled automatically accordingly.



In ACA function, the Peak-rms mode starts at the highest 1000A (600A for **Model 357s**) range to maximize measuring dynamic range. Before making measurement, press the **Peak-rms**  button momentarily again can manually select thru lower measuring dynamic range 400.0A or 40.00A for higher measuring resolutions.

Line-level Frequency (Hz) function

When ACV or ACA function is auto-selected or manual-selected, press **Hz** button momentarily toggles to Line-level Frequency (Hz) function. The Hz trigger level is determined by the selected function-range from where the Hz function is activated.

In ACA function, activating the Hz function during significant measurements can get the most appropriate trigger level to avoid electrical noises in most cases. Activating the Hz function at AC 40.00A (before making significant measurements) can get the lowest trigger level (highest sensitivity).

HOLD mode

When any function is auto-selected or manual-selected, press **HOLD ** button momentarily toggles to **Hold** mode. The annunciator “” turns on. **Hold** mode freezes the display for later viewing.

Notes on Displacement Power Factor & Total Power Factor

● **Introduction:** Power is the rate of change of energy with respect to time (in terms of voltage V and current A). Instantaneous (real) power $w = vi$ where v is the instantaneous voltage and i the instantaneous current. The average (real) power is the mean of vi and is given by:

$$W = \omega/2\pi \int vi dt, \text{ over the interval from } 0 \text{ to } 2\pi/\omega$$

● **Displacement Power Factor (more traditional):** Assuming V and A are pure sinusoidal waveforms without harmonics (as in most traditional cases), that is, $v = V \sin \omega t$ and $i = I \sin (\omega t - \theta)$, the expression can be simplified to:

$W = 1/2 \times V \times I \times \cos \theta$ where V and I are the peak values, θ is the displacement power factor angle, and $\cos \theta$ is the displacement power factor. Using RMS values, it is written as:

$$W = V_{rms} \times A_{rms} \times \cos \theta$$

Practically, in such cases without harmonics, θ is also called the phase-shift angle of the current A to the voltage V . An inductive circuit is said to have a lagging power factor since current A lags voltage V (phase-shift angle θ and thus $\sin \theta$ are both “+”), and a capacitive circuit is said to have a leading power factor since current A leads voltage V (phase-shift angle θ and thus $\sin \theta$ are both “-”).

● **Total Power Factor (encountering harmonics):** When encountering distorted waveforms with the presence of harmonics, however, the simplified power expression should not be used since substituting the above mentioned pure sinusoidal V and A functions cannot fulfill the actual conditions. *Cosine of phase-shift angle ($\cos \theta$), or the displacement power factor, is no longer the only component constituting the overall power factor. Harmonics do increase apparent power and thus decrease the overall power factor. That is, the Total Power Factor is actually affected by both phase-shift angle and harmonics, and is given by the expression:*

$$\text{Total Power Factor (PF)} = \text{Real Power (W)} / \text{Apparent Power (VA)}$$

In order to improve overall system power factor, nowadays power-system engineer needs to address both phase-shift and harmonics problems. Practically, harmonics should be dealt with (e.g. filtering out) before phase-shift to be corrected (e.g. installing capacitors in parallel with inductive loads).

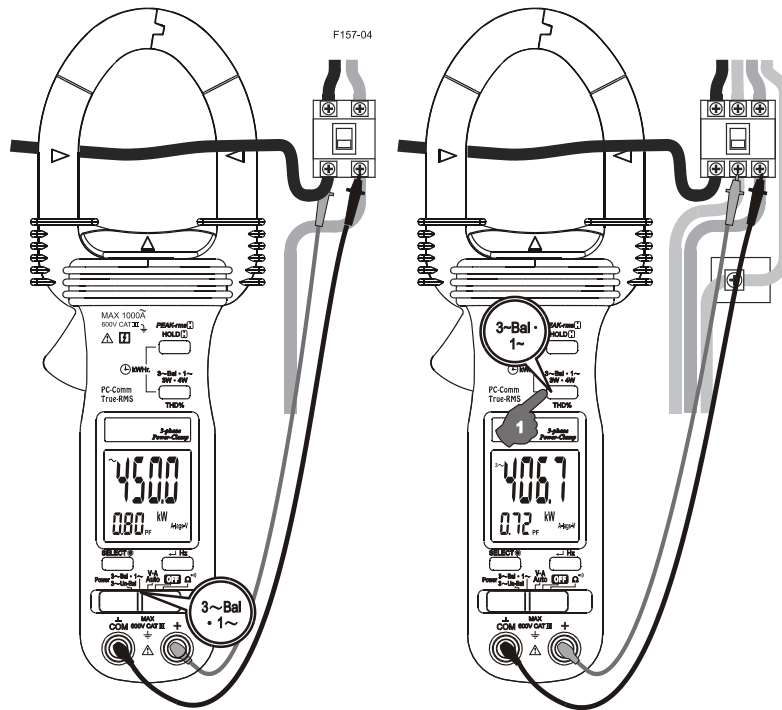

Single-Phase Power & 3-Phase Balanced-Load Power functions

Set the slide-switch function-selector to the “3~Bal • 1~” Power position.

- Default at last selected function.
- Press “3~Bal • 1~” button momentarily to toggle between “Single-Phase” and “3-Phase Balanced Load” Power functions. Annunciators “~” and “3~” turn on respectively.

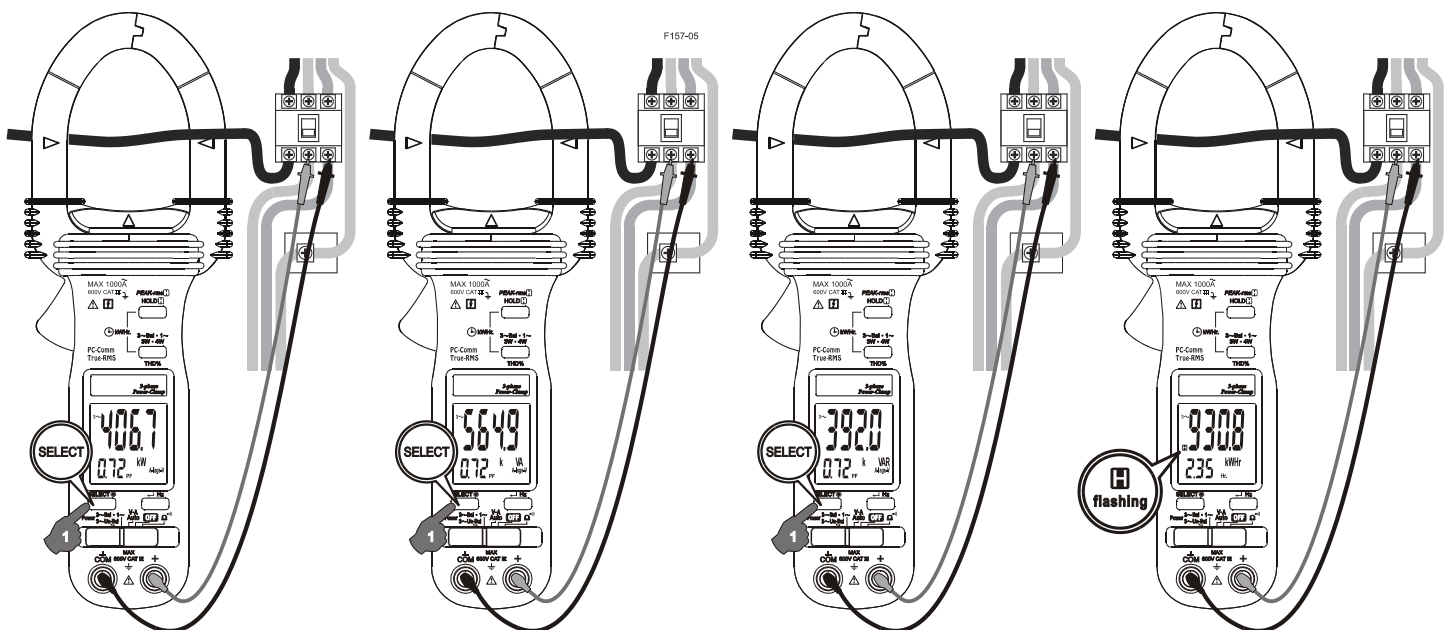

- Press **SELECT** button momentarily selects between **W** (real power), **VAR** (reactive power), **VA** (apparent power) & **kWhr** (real-time readings or stored result) functions. In **W** (real power), **VAR** (reactive power), or **VA** (apparent power) function:

1. **PF** (Total Power Factor) is displayed automatically in the secondary mini display.
2. Annunciator "**A-lags-V**" turns on to indicate an *inductive* circuit is being measured. That is, the Current waveform is lagging the Voltage waveform, and the phase-shift angle θ is "+".
3. On the contrary, together with significant **PF** values, *WITHOUT* "**A-lags-V**" being turned on indicates that a *capacitive* circuit is being measured. That is, the Current waveform is leading the Voltage waveform, and the phase-shift angle θ is "-".





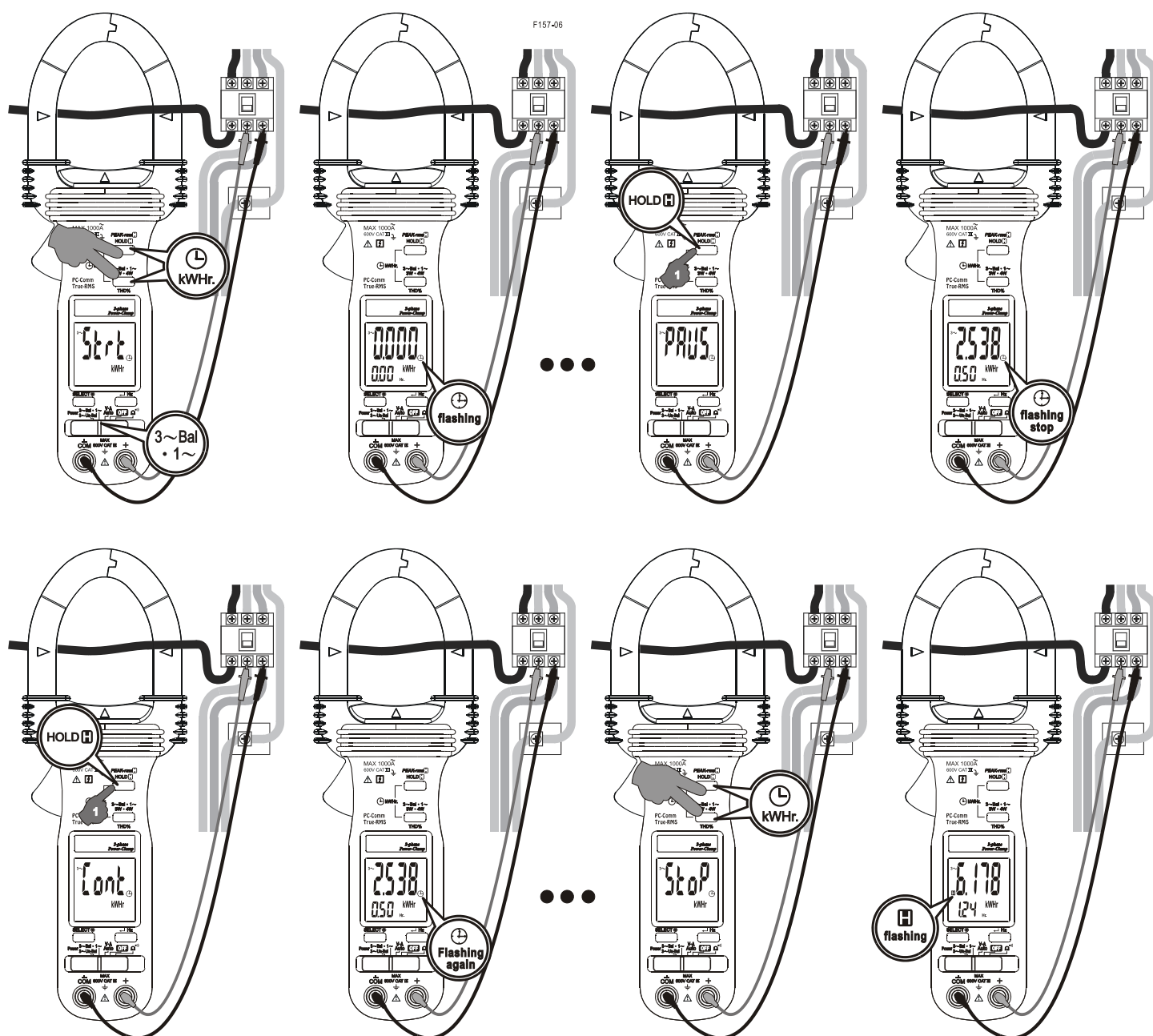

Note:





1. Under proper measurement setups for load circuits, the **W** (real power) readings are always positive. Negative **W** readings indicate reversed clamp-on jaws direction or test leads polarities, or even incorrect voltage lines are being measured as in 3-phase measurement setups. Correct them for proper "**A-lags-V**" indications.
2. When encountering largely distorted waveforms, "**A-lags-V**" detection might be affected due to the influence of harmonics. It is recommended to manage (e.g. filter out) harmonics problems before measuring/dealing with phase-shift problems.

kWhr (kilo-Watt-Hour) Recording function







Set the slide-switch function-selector to the “3~Bal . 1~” Power position. Setup power measurements as mentioned in the previous “Single-Phase Power & 3-Phase Balanced-Load Power functions” section





- To start (“”) kWhr Recording, press “3~Bal . 1~” and “HOLD” buttons at the same time. Annunciator “” turns on & flashes. kWhr accumulated time (in Hour) is displayed automatically in the secondary mini display.
- To pause (“”), press “HOLD” button momentarily. Annunciator “” stops flashing and is always on.
- To continue (“”), press the “HOLD” button momentarily again. Annunciator “” resumes flashing.

- To stop (“”), press the “3~Bal . 1~” and “HOLD” buttons at the same time again. Annunciator “” turns off. The **kWhr Recording** result is then displayed on the LCD for immediate viewing. Annunciator “” turns on & flashes.
- When the low battery annunciator “” turns on, the meter will stop (“”) **kWhr recording** session automatically and display **kWhr Recording** result as in above.

Note:

- During **kWhr Recording** session, real-time **W**, **VAR**, **VA** as well as **kWhr** accumulated readings can be selected by pressing the **SELECT** button momentarily. A flashing “” denotes that **kWhr Recording** is still under-going. An always on “” denotes that **kWhr Recording** is being paused.
- When **kWhr Recording** is not activated, **kWhr** stored result instead of accumulated readings is displayed when selected as in above. Annunciator “” turns on & flashes.
- The meter separately stores one Single-Phase and one 3-Phase-Balanced-Load **kWhr** result for later viewing. When they are being viewed, press “3~Bal . 1~” button momentarily to toggle between them.
- When the display readings exceed 9999kWhr/999hours, exponential readings are displayed. “2.3E4” kWhr represents 2.3×10^4 kWhr, or 23000 kWhr for example,.
- After the **kWhr Recording** session is stopped (“”) properly, the new result will supersede the previous one stored in the non-volatile memory. You can then switch off the meter for transportation, storage, or even battery changing with memory remained.
- To avoid mis-storage to memory, it is important to properly stop (“”) **kWhr Recording** session before sliding the slide-switch function-selector to any other function positions.

3-Phase 3-Wire (3~3W) Unbalanced-Load Power Function

- Set the slide-switch function-selector to the “3~Un-Bal” Power position. Press “3W.4W” button momentarily to select 3-Wire measurements. Annunciator “3W” turns on.
- Clamp the jaws around “Line 1” as reminded by annunciators “ L1”, and connect Black test probe (**COM** terminal) to “Line 3” and Red test probe (+ terminal) to “Line 1” as reminded by annunciators “ 3-1” on mini-display.
- When the reading is stable, press “” button momentarily to enter the first measuring value.
- Then clamp the jaws around “Line 2” as reminded by annunciators “ L2”, and connect Black test probe (**COM** terminal) to “Line 3” and Red test probe (+ terminal) to “Line 2” as reminded by annunciators “ 3-2” on mini-display.

- When the reading is stable, press “ \leftarrow ” button momentarily to enter the second measuring value. The meter will then calculate, store and display the total 3-Phase Power result automatically. Annunciators “ A L1 L2 L3” turn on.
- Press “ \leftarrow ” button momentarily again for new measurements.
- Press “**SELECT**” button momentarily to view (“ L1 ”) the last stored result. Annunciator “ H ” turns on & flashes. Press “**SELECT**” button momentarily again to continue (“ L2 ”).

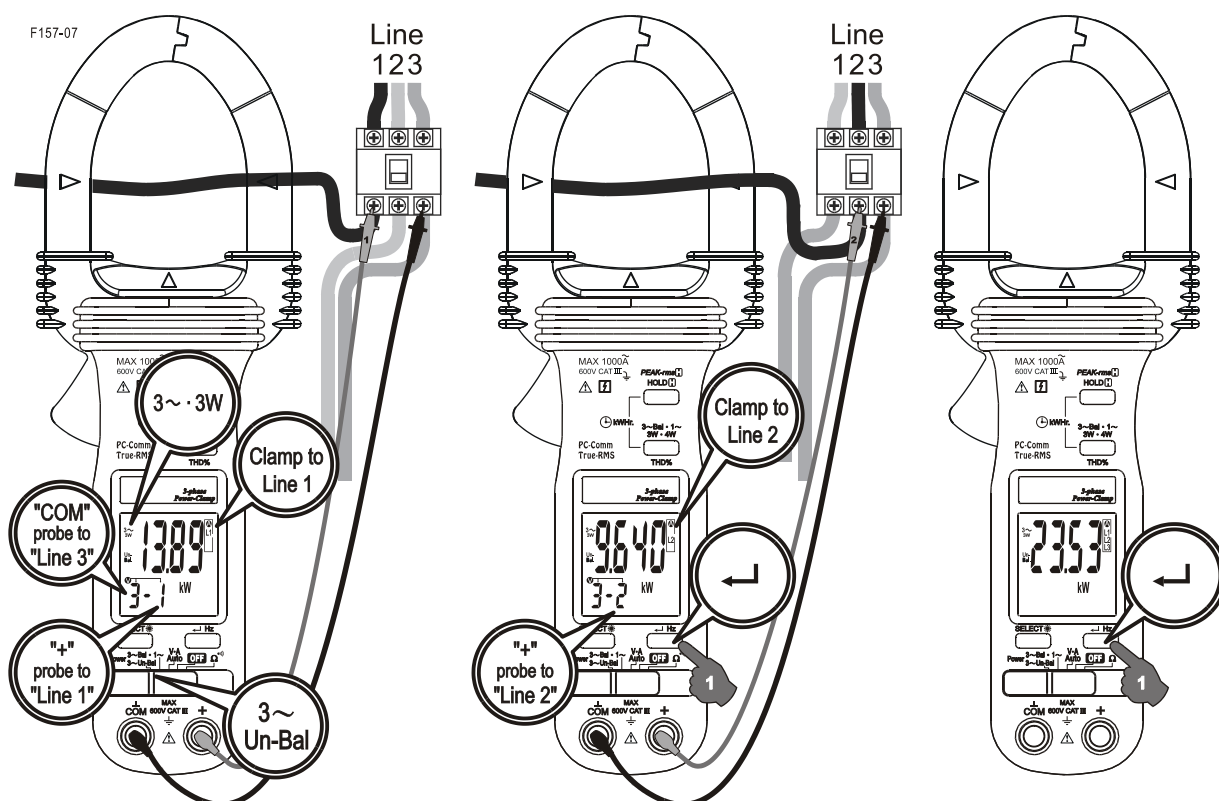

3-Phase 4-Wire (3~4W) Unbalanced-Load Power function

- Set the slide-switch function-selector to the “3~Un-Bal” Power position. Press “3W.4W” button momentarily to select 4-Wire measurements. Annunciator “4W” turns on.
- Clamp the jaws around “Line 1” as reminded by annunciators “ A L1”, and connect Black test probe (**COM** terminal) to “Line n (neutral)” and Red test probe (+ terminal) to “Line 1” as reminded by annunciators “ V n-1” on mini-display.
- When the reading is stable, press “ \leftarrow ” button momentarily to enter the first measuring value.
- Then clamp the jaws around “Line 2” as reminded by annunciators “ A L2”, and connect Black test probe (**COM** terminal) to “Line n (neutral)” and Red test probe (+ terminal) to “Line 2” as reminded by annunciators “ V n-2” on mini-display.

- When the reading is stable, press “ \leftarrow ” button momentarily to enter the second measuring value.
- Then clamp the jaws around “Line 3” as reminded by annunciators “ A L3”, and connect Black test probe (COM terminal) to “Line n (neutral)” and Red test probe (+ terminal) to “Line 3” as reminded by annunciators “ V n-3” on mini-display.
- When the reading is stable, press “ \leftarrow ” button momentarily to enter the third measuring value. The meter will then calculate, store and display the total 3-Phase Power result automatically. Annunciators “ A L1 L2 L3” turn on.
- Press “ \leftarrow ” button momentarily again for new measurements.
- Press “SELECT” button momentarily to view (“ H ”) the last stored result. Annunciator “ H ” turns on & flashes. Press “SELECT” button momentarily again to continue (“ L ”).

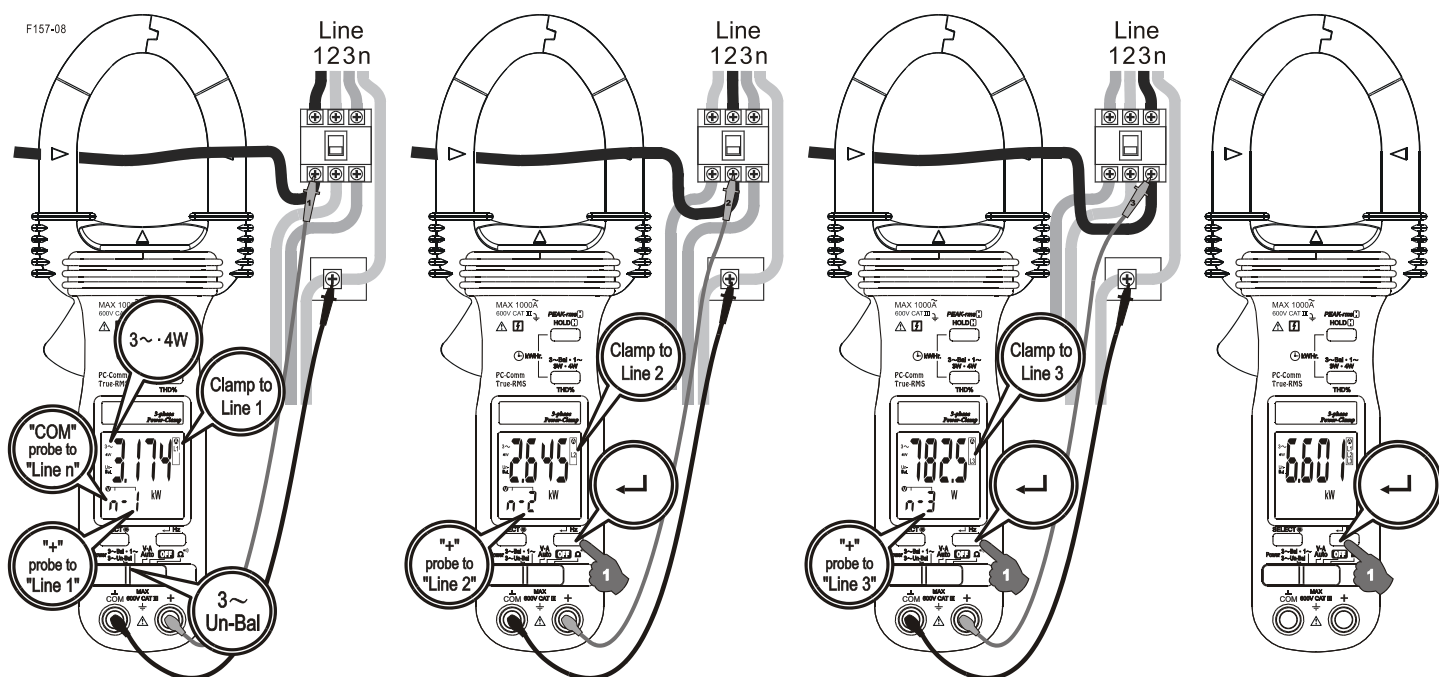

$\Omega/\cdot\cdot\cdot)$ functions

Set the slide-switch function-selector to the $\Omega/\cdot\cdot\cdot)$ function position. Default at last selected function. Press **SELECT** button to toggle between Ω and $\cdot\cdot\cdot)$ measurement functions.

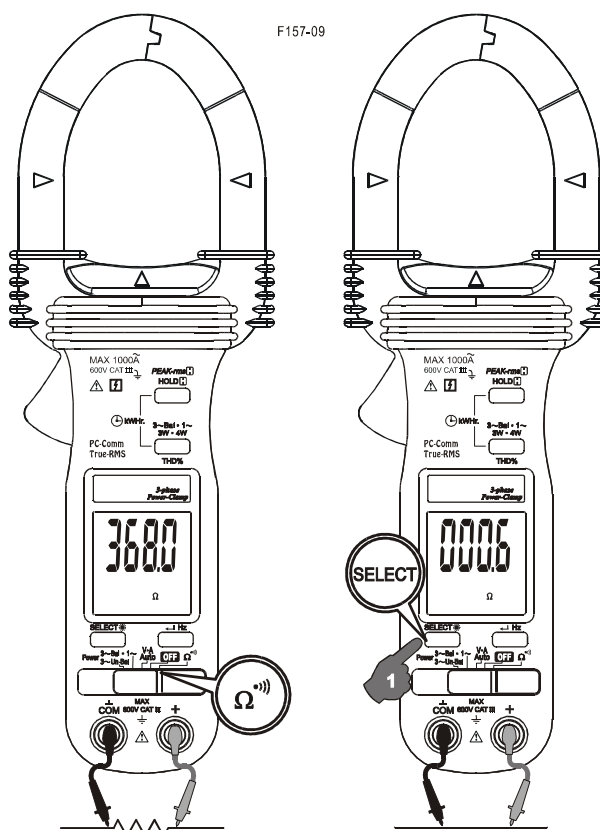

Backlighting display

Press the **SELECT** button for 1 second or more to toggle the display backlight on or off.

Auto Power Off (APO)

The meter turns off after approximately 30 minutes of neither switch nor button activity. To wake up the meter from APO, press **SELECT** button or slide the function-selector to **OFF** position and back on again. Always turn the function-selector to **OFF** when the meter is not in use.

Auto Power Off Quick Test

Press-and-hold the **3W.4W** button while powering the meter on. The LCD displays “**3W.4W**” & “**F5E**” to confirm activation right after the **3W.4W** button is released. Quick test APO timing is 10 seconds after such activation.

Disabling Auto-Power-Off (APO)

Press-and-hold the **HOLD** button while powering the meter on. The LCD displays “**3W.4W**” & “**OFF**” to confirm activation right after the **HOLD** button is released.

Line Frequency setup

Press-and-hold the **Hz** button while powering the meter on. LCD displays the last 50Hz or 60 Hz setup. Press **SELECT** button momentarily to select 50Hz or 60Hz to cope with your local line frequency. Press **Hz** button for one second to store your selection and resume measurements. Incorrect line frequency setup will introduce errors to THD%.

PC computer interface capabilities

The instrument equips with an optical isolated data output port at the bottom case near the battery compartment. Optional purchase PC interface kit BRUA-13X (including BA-1XX Optical Adapter Back, BC-100R Cable, BUA-2303 USB-to-Serial adaptor & Bs software/driver CD) is required to connect the meter to PC computer USB port. The Data Recording System software equips with a digital meter, an analog meter, a comparator meter, and a Data Graphical recorder. Refer to the README file comes with the interface kit for further details.

5) MAINTENANCE

WARNING

To avoid electrical shock, disconnect the meter from any circuit, remove the test leads from the input jacks and turn OFF the meter before opening the case. Do not operate with open case.

Trouble Shooting

If the instrument fails to operate, check batteries and test leads etc., and replace as necessary. Double check operating procedure as described in this user's manual

If the instrument voltage-resistance input terminal has subjected to high voltage transient (caused by lightning or switching surge to the system) by accident or abnormal conditions of operation, the series fusible resistors will be blown off (become high impedance) like fuses to protect the user and the instrument. Most measuring functions through this terminal will then be open circuit. The series fusible resistors and the spark gaps should then be replaced by qualified technician. Refer to the LIMITED WARRANTY section for obtaining warranty or repairing service.

Cleaning and Storage

Periodically wipe the case with a damp cloth and mild detergent; do not use abrasives or solvents. If the meter is not to be used for periods of longer than 60 days, remove the batteries and store them separately

Battery replacement

The meter uses standard 1.5V AAA Size (NEDA 24A or IEC LR03) battery X 2
Loosen the 2 captive screws from the battery cover case. Lift the battery cover case.
Replace the batteries. Replace battery cover case. Re-fasten the screws.

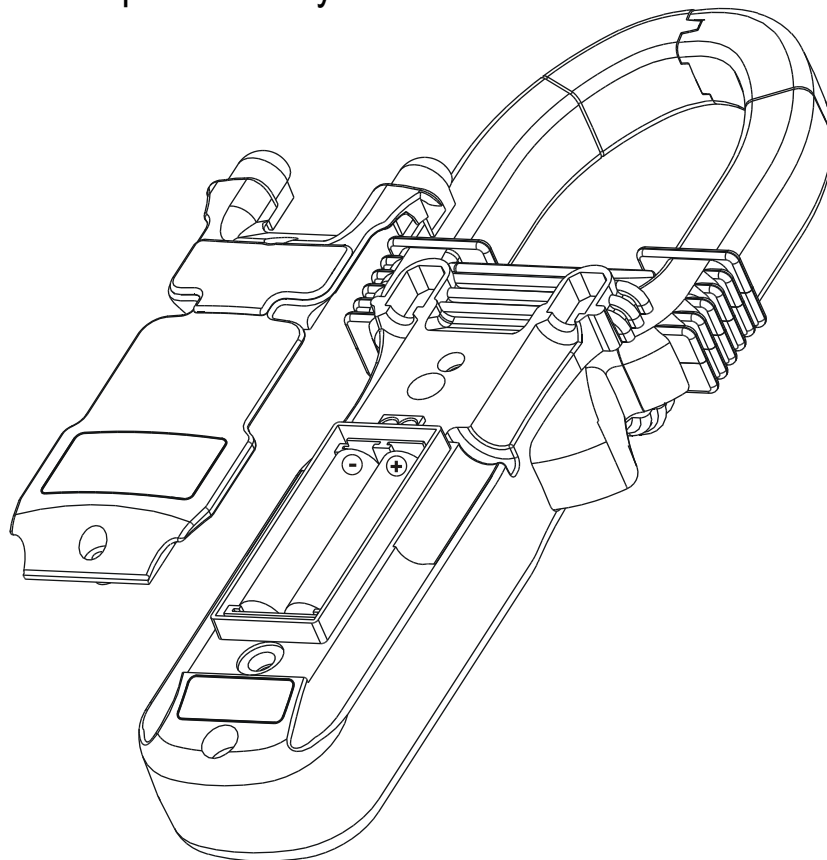

6) Specifications

General Specifications

Display :

Voltage functions: 6000 counts LCD display

Power, Ohm & Hz functions: 9999 counts LCD display

ACA clamp-on function: 4000 counts LCD display

Update Rate :

Power function: 2 per second nominal

Voltage, ACA clamp-on & Ohm functions: 2 per second nominal

Hz function: 1 per second nominal

Polarity : Automatic

Low Battery : Below approx. 2.4V

Operating Temperature : 0°C to 40°C

Relative Humidity : Maximum relative humidity 80% for temperature up to 31°C
decreasing linearly to 50% relative humidity at 40°C

Altitude : Operating below 2000m

Storage Temperature : -20°C to 60°C, < 80% R.H. (with battery removed)

Temperature Coefficient : nominal $0.15 \times$ (specified accuracy)/ $^{\circ}\text{C}$ @(0°C - 18°C or 28°C - 40°C), or otherwise specified

Sensing : True RMS sensing

Safety : Meets IEC/UL/EN61010-1 Ed. 3.0, IEC/EN61010-2-032 Ed. 3.0, IEC/EN61010-2-033 Ed. 1.0, IEC/UL/EN61010-031 Ed. 1.1 & CAN/CSA-C22.2 No. 61010-1-12 Ed. 3.0:

Measurement Category : III 600 Volts ac & dc

Transient protection : 6.5kV (1.2/50 μs surge)

Pollution degree : 2

E.M.C. : Meets EN61326-1:2006 (EN55022, EN61000-3-2, EN61000-3-3, EN61000-4-2, EN61000-4-3, EN61000-4-4, , EN61000-4-5, EN61000-4-6, EN61000-4-8, EN61000-4-11)

In an RF field of 3V/m:

Total Accuracy = Specified Accuracy + 50 digits

Performance above 3V/m is not specified

Overload Protections :

ACA Clamp-on jaws :

AC 1000A rms continuous for **Model 157s**;

AC 600A rms continuous for **Model 357s**

+ & COM terminals (all functions) : 600VDC/VAC rms

Power Supply : standard 1.5V AAA Size (NEDA 24A or IEC LR03) battery X 2

Power Consumption :

Voltage, ACA, Hz & Power functions: 11mA typical

Ohm function: 5.5mA typical

APO Timing : Idle for 30 minutes

APO Consumption : 4 μA typical

Dimension : L224 X W78 X H40 mm for **Model 157s**; L189 X W78 X H40 mm for **Model 357s**

Weight : 224 gm approx for **Model 157s**; 192 gm approx for **Model 357s**

Jaw opening & Conductor diameter : 45mm max for **Model 157s**; 26mm max for **Model 357s**

Special features : Backlighted display; AutoVA™ (Auto Selection on ACV, DCV or ACA functions); selectable Power parameters of W, VAR & VA with Total Power Factor in dual-display; Total harmonic distortion THD%-F in dual-display (**Model 157s** only); kWhr Recording; Display Hold; PEAK-rms HOLD; PC-Comm computer interface capabilities

Accessories : Test leads (pair), batteries installed, user's manual & soft carrying pouch

Optional accessories : PC interface kit BRUA-13X (including BA-1XX Optical Adapter

Back, BC-100R Cable, BUA-2303 USB-to-Serial adaptor & Bs software/driver CD)

Electrical Specifications

Accuracy is \pm (% reading digits + number of digits) or otherwise specified, at 23 °C \pm 5 °C & less than 75% R.H.

True RMS ACV & ACA clamp-on accuracies are specified from 0% to 100% of range or otherwise specified. Maximum Crest Factor are as specified below, and with frequency spectrums, besides fundamentals, fall within the meter specified AC bandwidth for non-sinusoidal waveforms. Fundamentals are specified at 50Hz and 60Hz.

AC Voltage

RANGE	Accuracy
50Hz / 60Hz	
600.0V	0.5% + 5d
45Hz ~ 500Hz	
600.0V	1.5% + 5d
500Hz ~ 3.1kHz	
600.0V	2.5% + 5d

CMRR : >60dB @ DC to 60Hz, $R_s=1k\Omega$

Input Impedance: $2M\Omega$, 30pF nominal

Crest Factor:

Model 157s: < 2.3 : 1 at full scale & < 4.6 : 1 at half scale

Model 357s: < 2 : 1 at full scale & < 4 : 1 at half scale

ACV AutoVA™ Threshold: 30VAC (40Hz ~ 500Hz only) nominal

DC Voltage

RANGE	Accuracy
600.0V	0.5% + 5d

NMRR : >50dB @ 50/60Hz

CMRR : >120dB @ DC, 50/60Hz, $R_s=1k\Omega$

Input Impedance: $2M\Omega$, 30pF nominal

DCV AutoVA™ Threshold: 2.4VDC nominal

ACA Current (Clamp-on)

RANGE	Accuracy ^{1) 2)}
50Hz / 60Hz	
40.00A, 400.0A, 1000A (600A for Model 357s)	1.0% + 5d
45Hz ~500Hz	
40.00A, 400.0A	2.0% + 5d
1000A (600A for Model 357s)	2.5% + 5d
500Hz ~ 3.1kHz	
40.00A, 400.0A	2.5% + 5d
1000A (600A for Model 357s)	3.0% + 5d

ACA AutoVA™ Threshold: 1A AC (40Hz ~ 500Hz only) nominal

Crest Factor:

Model 157s:

- < 2.5 : 1 at full scale & < 5.0 : 1 at half scale for 40.00A & 400.0A ranges
- < 1.4 : 1 at full scale & < 2.8 : 1 at half scale for 1000A range

Model 357s:

- < 3 : 1 at full scale & < 6 : 1 at half scale for 40.00A, 400.0A & 600A ranges

¹⁾Induced error from adjacent current-carrying conductor: < 0.06A/A

²⁾Specified accuracy is from 1% to 100% of range and for measurements made at the jaw center. When the conductor is not positioned at the jaw center, position errors introduced are:

- Add 1% to specified accuracy for measurements made WITHIN jaw marking lines (away from jaw opening)
- Add 4% to specified accuracy for measurements made BEYOND jaw marking lines (toward jaws opening)

PEAK-rms HOLD (ACA & ACV only)

Response: 65ms to >90%

THD%-F (Model 157s only)

RANGE	Harmonic order	Accuracy ¹⁾
0.0% ~50.0%	Fundamental	1.5% + 6d
	2nd ~ 3rd	7% + 6d
	4th ~ 21st	2.5% + 6d ^{2) 3)}
	22nd ~ 51st	10% + 10d ⁴⁾
50.0% ~100%	2nd ~ 3rd	Unspecified
	4th ~ 21st	2.5% + 6d ^{5) 6)}
	22nd ~ 51st	10% + 10d ⁴⁾
100% ~450% ⁷⁾	2nd ~ 3rd	Unspecified
	4th ~ 21st	7% + 6d ^{2) 4)}
	22nd ~ 51st	Unspecified

THD%-F is defined as: (Total Harmonic RMS / Fundamental RMS) x 100%

¹⁾Accuracy specified @ fundamental $\geq 70V$ & Total RMS $\leq 600V$ for ACV THD%-F, fundamental $\geq 6A$ & Total RMS $\leq 1000A$ for ACA THD%-F, and Crest Factors @ :

< 2.5 for 600V Range

< 2.5 for 40A Range

< 3.0 for 400A Range

< 1.6 for 1000A Range

²⁾Add 4d to specified accuracy @ 40A Range

³⁾Add 4.5% to specified accuracy @ 1000A range

⁴⁾Unspecified @ 1000A range

⁵⁾Add 1% + 4d to specified accuracy @ 40A Range

⁶⁾Add 4.5% to specified accuracy @ 400A ~ 750A; unspecified @ > 750A

⁷⁾~150% for 600V Range

Frequency

RANGE	Accuracy
5Hz ~ 500Hz	0.5%+4d

Sensitivity (Sine RMS)

40A range: > 4A

400A range: > 40A

1000A (600A for model 357) range: > 400A

600V range: > 30V

Ohms

RANGE	Accuracy
999.9Ω	1.0% + 6d

Open Circuit Voltage : 0.4VDC typical

Audible Continuity Tester

Audible threshold: between 10Ω and 300Ω.

Response time: 250μs

Single-Phase & 3-Phase Balanced-Load Power

RANGE ⁵⁾ 0 ~ 600.0kVA	Accuracy ^{1) 2) 3)}				
	F ~ 10th	11th ~ 45th	46th ~ 51st		
@ PF = 0.99 ~ 0.1	2.0%+6d	3.5%+6d	5.5%+6d		
RANGE ⁵⁾ 0 ~ 600.0kW / kVAR	Accuracy ^{1) 2) 4)}				
	F ~ 10th	11th ~ 25th	26th ~ 45th	46th ~ 51st	
	@ PF = 0.98 ~ 0.70	2.0%+6d	3.5%+6d	4.5%+6d	10%+6d
	@ PF = 0.70 ~ 0.50	3.0%+6d			
	@ PF = 0.50 ~ 0.30	4.5%+6d		15%+6d	
@ PF = 0.30 ~ 0.20	10%+6d				

¹⁾Specified accuracy is for ACA clamp measurement at the center of jaws. When the conductor is not positioned at the jaw center, position errors introduced are:

Add 1% to specified accuracy for ACA measurements made WITHIN jaw marking lines (away from jaw opening)

Accuracy is not specified for ACA measurement made BEYOND jaw marking lines (toward jaws opening)

²⁾Add 4d to specified accuracy for 3-Phase Balanced-Load Power measurements.

³⁾Add 1% to specified accuracy @ ACA fundamental < 6A or ACV fundamental < 90V. Accuracy is not specified @ ACA fundamental < 1A or ACV fundamental < 30V

⁴⁾Add 1% to specified accuracy @ ACA fundamental < 6A or ACV fundamental < 90V. Accuracy is not specified @ ACA fundamental < 2A or ACV fundamental < 50V

⁵⁾ 0 ~ 360.0 for model 357

Total Power Factor (PF)

RANGE	Accuracy ¹⁾	
	0.10 ~ 0.99	F ~ 21st
3d		5d

¹⁾Specified accuracy @ ACA fundamental > 2A ; ACV fundamental > 50V

A-lags-V Indication:

LCD annunciator “A-lags-V” turns on to indicate an inductive circuit, or Current A lags Voltage V (i.e., phase-shift angle θ is “+”).

A-lags-V Indication is specified at 50/60Hz fundamental without the presence of harmonics, and at ACV > 90V, ACA > 9A and PF < 0.95

kWhr (kilo-Watt-Hour Energy)

Time base accuracy: < 30ppm

Non-volatile memory: Separately stores one 3-Phase-Balanced-Load and one Single-Phase result

3-Phase Unbalanced-Load Power

This 3-Phase Unbalanced-Load Power measurement is achieved thru the calculation of discrete single-phase measurements that are taken one at a time manually. Since it is not real-time on all 3 phases simultaneously, it is intended only for stable power conditions without significant power fluctuations over the time of measurements. Result accuracy is hence the accumulated accuracy of the discrete single-phase measurements plus the associated fluctuations.

LIMITED WARRANTY

BRYMEN warrants to the original product purchaser that each product it manufactures will be free from defects in material and workmanship under normal use and service within a period of one year from the date of purchase. BRYMEN's warranty does not apply to accessories, fuses, fusible resistors, spark gaps, batteries or any product which, in BRYMEN's opinion, has been misused, altered, neglected, or damaged by accident or abnormal conditions of operation or handling.

To obtain warranty service, contact your nearest BRYMEN authorized agent or send the product, with proof of purchase and description of the difficulty, postage and insurance prepaid, to BRYMEN TECHNOLOGY CORPORATION. BRYMEN assumes no risk for damage in transit. BRYMEN will, at its option, repair or replace the defective product free of charge. However, if BRYMEN determines that the failure was caused by misused, altered, neglected, or damaged by accident or abnormal conditions of operation or handling, you will be billed for the repair.

THIS WARRANTY IS EXCLUSIVE AND IS IN LIEU OF ALL OTHER WARRANTIES, EXPRESSED OR IMPLIED, INCLUDING BUT NOT LIMITED TO ANY IMPLIED WARRANTY OR MERCHANTABILITY OR FITNESS FOR A PARTICULAR PURPOSE OR USE. BRYMEN WILL NOT BE LIABLE FOR ANY SPECIAL, INDIRECT, INCIDENTAL OR CONSEQUENTIAL DAMAGES.



BRYMEN TECHNOLOGY CORPORATION

TEL:+886 2 2226 3396

FAX:+886 2 2225 0025

<http://www.brymen.com>



PRINTED ON RECYCLABLE PAPER, PLEASE RECYCLE
COPYRIGHT © **MMXIV** Btc, ALL RIGHTS RESERVED
P/N: 7M1C-**1411-0000** PRINTED IN TAIWAN