

USER'S MANUAL



BM821s, BM822s, BM827s, BM829s
BM521s, BM525s

1) SAFETY

Terms in this manual

WARNING identifies conditions and actions that could result in serious injury or even death to the user.

CAUTION identifies conditions and actions that could cause damage or malfunction in the instrument.

This manual contains information and warnings that must be followed for operating the instrument safely and maintaining the instrument in a safe operating condition. If the instrument is used in a manner not specified by the manufacturer, the protection provided by the instrument may be impaired. The meter is intended only for indoor use.

The meter protection rating, against the users, is double insulation per IEC/UL/EN61010-1 Ed. 3.0, IEC/EN61010-2-030 Ed. 1.0, IEC/EN61010-2-033 Ed. 1.0, IEC/UL/EN61010-031 Ed. 1.1 and CAN/CSA-C22.2 No. 61010-1-12 Ed. 3.0 to Category IV 1000 Volts AC & DC.

Terminals (to COM) measurement category:

V / mA μ A / A : Category IV 1000 Volts AC & DC

Per IEC61010-1 2nd Ed. (2001) Measurement Category

Measurement Category IV (CAT IV) is for measurements performed at the source of the low-voltage installation. Examples are electricity meters and measurements on primary overcurrent protection devices and ripple control units.

Measurement Category III (CAT III) is for measurements performed in the building installation. Examples are measurements on distribution boards, circuit-breakers, wiring, including cables, bus-bars, junction boxes, switches, socket-outlets in the fixed installation, and equipment for industrial use and some other equipment, for example, stationary motors with permanent connection to the fixed installation.

Measurement Category II (CAT II) is for measurements performed on circuits directly connected to the low voltage installation. Examples are measurements on household appliances, portable tools and similar equipment.







WARNING

To reduce the risk of fire or electric shock, do not expose this product to rain or moisture. To avoid electrical shock hazard, observe the proper safety precautions when working with voltages above 60 VDC or 30 VAC rms. These voltage levels pose a potential shock hazard to the user. Do not touch test lead tips or the circuit being tested while power is applied to the circuit being measured. Keep your fingers behind the finger guards of the test leads during measurement. Inspect test leads, connectors, and probes for damaged insulation or exposed metal before using the instrument. If any defects are found, replace them immediately. Do not measure any current that exceeds the current rating of the protection fuse. Do not attempt a current measurement to any circuit where the open circuit voltage is above the protection fuse voltage rating. Suspected open circuit voltage should be checked with voltage functions. Never attempt a voltage measurement with the test lead inserted into the $\mu\text{A}/\text{mA}$ or A input jack. Only replace the blown fuse with the proper rating as specified in this manual. **Only use the test lead provided with the equipment or UL Listed Probe Assembly rated CAT IV 1000V or better.**

CAUTION

Disconnect the test leads from the test points before changing functions. Always set the instrument to the highest range and work downward for an unknown value when using manual ranging mode.

INTERNATIONAL ELECTRICAL SYMBOLS

	Caution ! Refer to the explanation in this Manual
	Caution ! Risk of electric shock
	Earth (Ground)
	Double Insulation or Reinforced insulation
	Fuse
	AC--Alternating Current
	DC--Direct Current

2) CENELEC DIRECTIVES

The instruments conform to CENELEC Low-voltage directive 2006/95/EC and Electromagnetic compatibility directive 2004/108/EC

3) PRODUCT DESCRIPTION

Note: Top of the line model is used as representative for illustration purposes. Please refer to your respective model for function availability.

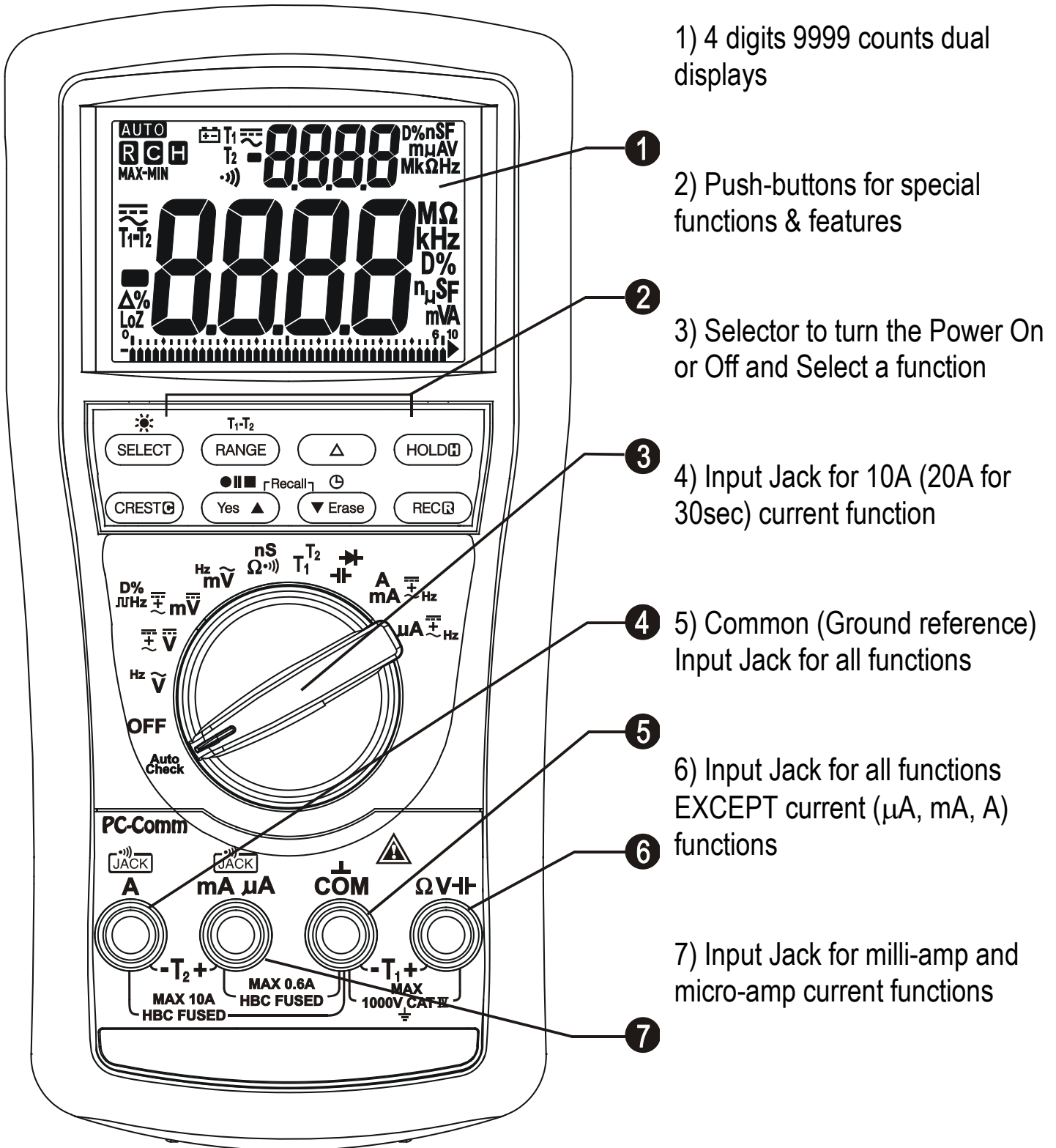

Analog bar-graph

The analog bar graph provides a visual indication of measurement like a traditional analog meter needle. It is excellent in detecting faulty contacts, identifying potentiometer clicks, and indicating signal spikes during adjustments.

Average sensing RMS calibrated

RMS (Root-Mean-Square) is the term used to describe the effective or equivalent DC value of an AC signal. Most digital multimeters use average sensing RMS calibrated technique to measure RMS values of AC signals. This technique is to obtain the average value by rectifying and filtering the AC signal. The average value is then scaled upward (calibrated) to read the RMS value of a sine wave. In measuring pure sinusoidal waveform, this technique is fast, accurate and cost effective. In measuring non-sinusoidal waveforms, however, significant errors can be introduced because of different scaling factors relating average to RMS values.

True RMS

True RMS is a term which identifies a DMM that responds accurately to the effective RMS value regardless of the waveforms such as: square, sawtooth, triangle, pulse trains, spikes, as well as distorted waveforms with the presence of harmonics. Harmonics may cause :

- 1)Overheated transformers, generators and motors to burn out faster than normal
- 2)Circuit breakers to trip prematurely
- 3)Fuses to blow
- 4)Neutrals to overheat due to the triplen harmonics present on the neutral
- 5)Bus bars and electrical panels to vibrate

Crest Factor

Crest Factor is the ratio of the Crest (instantaneous peak) value to the True RMS value, and is commonly used to define the dynamic range of a True RMS DMM. A pure sinusoidal waveform has a Crest Factor of 1.4. A badly distorted sinusoidal waveform normally has a much higher Crest Factor.

4) OPERATION

CAUTION

Before and after hazardous voltage measurements, test the voltage function on a known source such as line voltage to determine proper meter functioning.

AutoCheck™ $\tilde{V} \cdot \bar{V} \cdot \Omega$

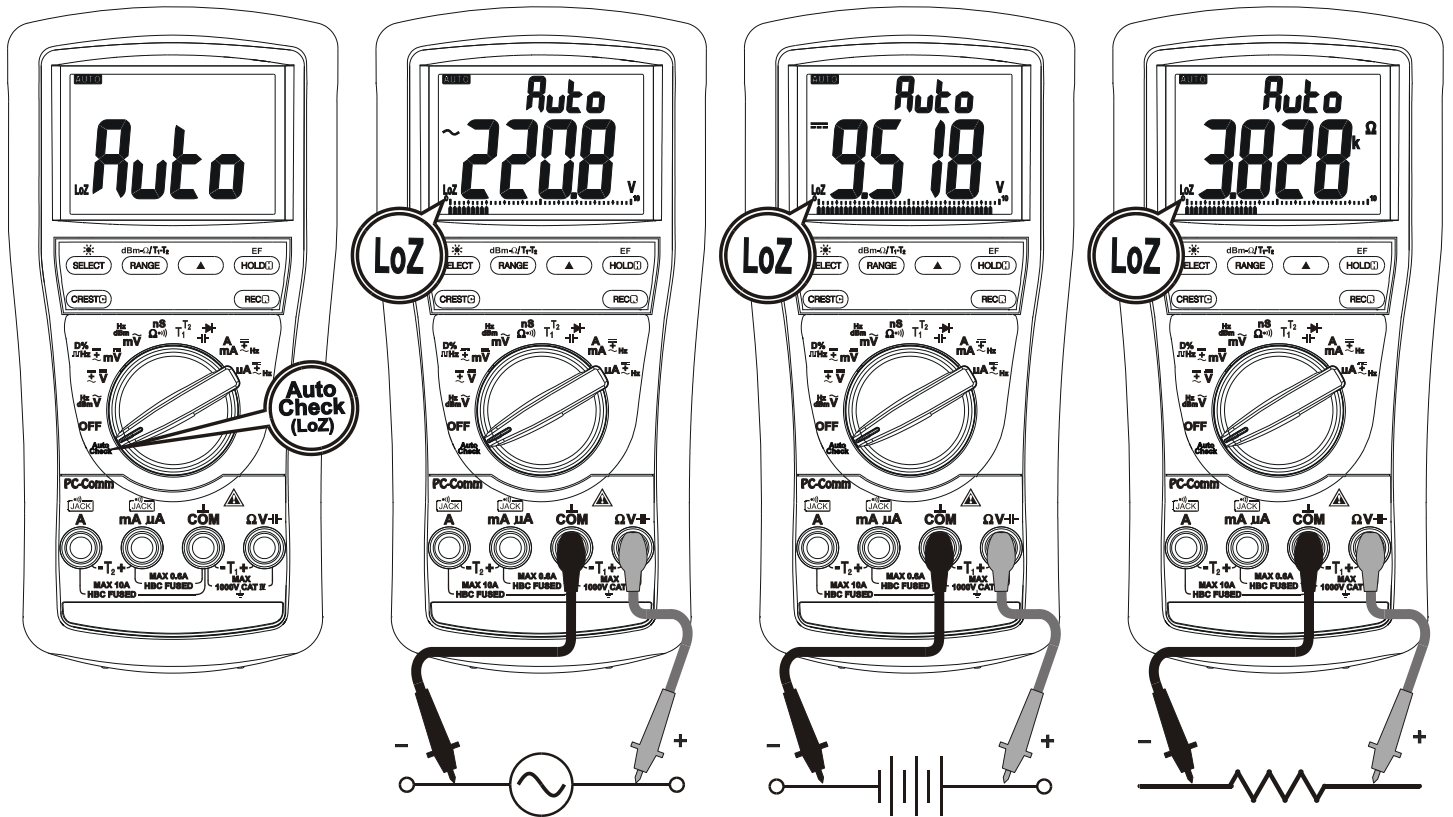

AutoCheck™ mode (Models 525s, 521s, 829s only)

This innovative **AutoCheck™** feature automatically selects measurement function of DCV, ACV or Resistance (Ω) based on the input via the test leads.

- With no input, the meter displays “Auto” when it is ready.
- With no voltage signal but a resistance below $60M\Omega$ is present, the meter displays the resistance value. When below “Audible Threshold” is present, the meter further gives a continuity beep tone.
- When a signal above the threshold of 1.5V DC or 3V AC up to the rated 1000V is present, the meter displays the voltage value in appropriate DC or AC, whichever larger in peak magnitude.

Note:

***Range-Lock and Function-Lock Feature:** When a measurement reading is being displayed in AutoCheck™ mode, press the **RANGE** or **SELECT** button momentarily 1 time can lock the range or function it was in. Press the button momentarily repeatedly to step through the ranges or functions.

***As Hazardous-Alert:** When making resistance measurements in AutoCheck™ mode, an unexpected display of voltage readings alerts you that the object under test is being energized.

***Ghost-voltage Buster:** Ghost-voltages are unwanted stray signals coupled from adjacent hard signals, which confuse common multimeter voltage measurements. Our AutoCheck™ mode provides low (ramp-up) input impedance (approx. $3k\Omega$ at low voltage) to drain ghost voltages leaving mainly hard signal values on meter readings. It is an invaluable feature for precise indication of hard signals, such as distinguishing between hot and open wires (to ground) in electrical installation applications.

WARNING:

AutoCheck™ mode input impedance increases abruptly from initial $3k\Omega$ to a few hundred $k\Omega$'s on high voltage hard signals. “LoZ” displays on the LCD to remind the users of being in such low impedance mode. Peak initial load current, while probing 1000VAC for example, can be up to 471mA ($1000V \times 1.414 / 3k\Omega$), decreasing abruptly to approx. 3.1mA ($1000V \times 1.414 / 460k\Omega$) within a fraction of a second. Do not use AutoCheck™ mode on circuits that could be damaged by such low input impedance. Instead, use rotary selector \tilde{V} or \bar{V} high input impedance voltage modes to minimize loading for such circuits.

dBm +Hz (Model 829s only), Hz +ACV, ACV +Hz functions

Press the **SELECT** button momentarily to select the subject functions in sequence. Last selection will be saved as power up default for repeat measurement convenience.

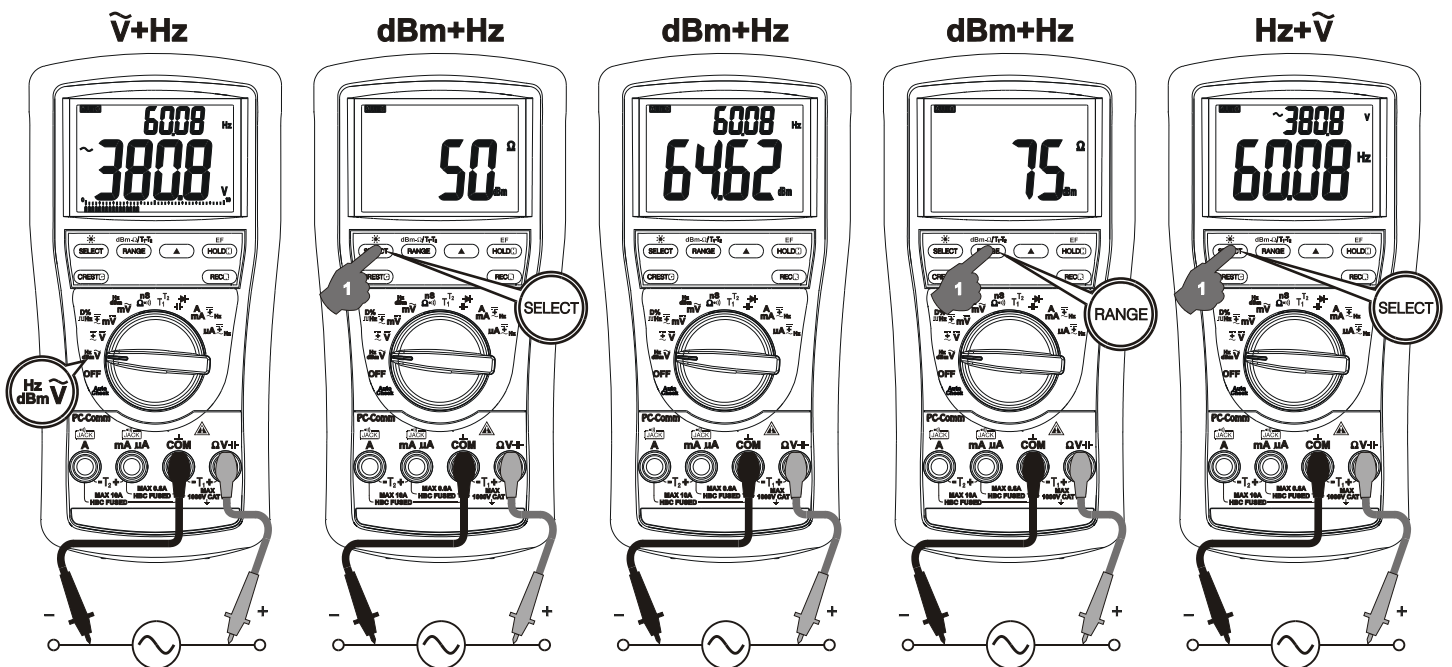

Note: Hz Input sensitivity varies automatically with voltage (current function alike) range selected. 1V range has the highest and the 1000V range has the lowest. Auto-ranging

measurements normally set the most appropriate trigger level. You can also press the **RANGE** button momentarily to select another trigger level (voltage range) manually. If the Hz reading becomes unstable, select higher voltage range to avoid electrical noise. If the reading shows zero, select lower voltage range.

Note: In **dBm** +Hz function, power up default reference impedance will be displayed for 1 second before displaying the dBm readings. Press **dBm-Ω (RANGE)** button momentarily to select different reference impedance of 4, 8, 16, 32, 50, 75, 93, 110, 125, 135, 150, 200, 250, 300, 500, 600, 800, 900, 1000, up to 1200Ω. Last selection will be saved as power up default for repeat measurement convenience. Manual trigger level selection on Hz reading is not available.

DC+ACV +ACV (Models 525s, 521s, 829s only), DCV, DCV +ACV functions

Press the **SELECT** button momentarily to select the subject functions in sequence. Last selection will be saved as power up default for repeat measurement convenience.

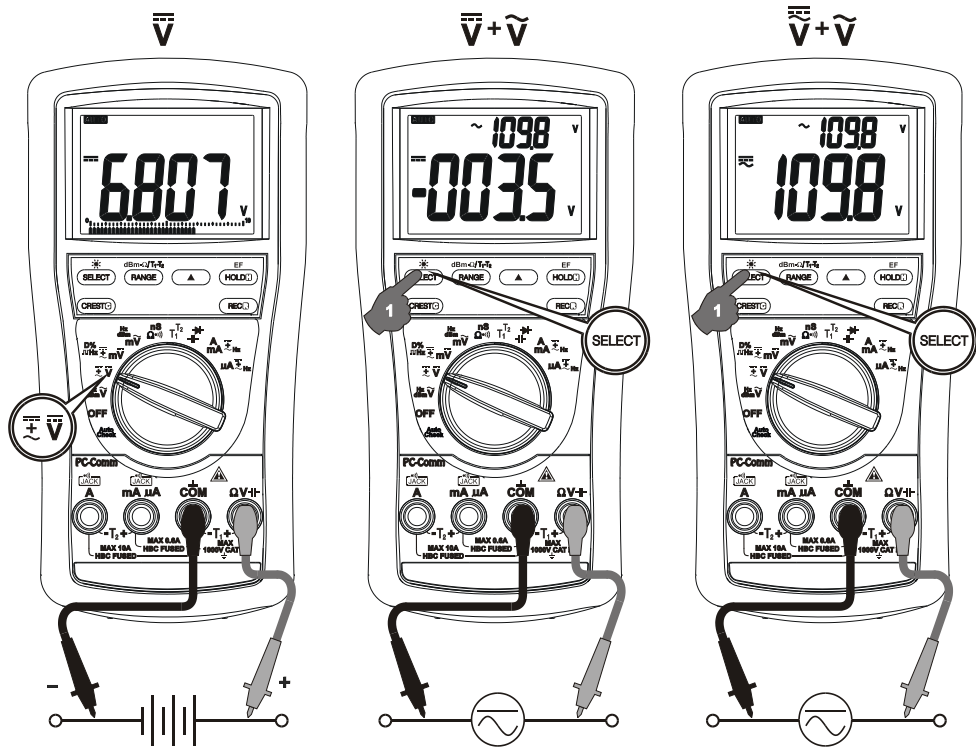

Models 525s, 521s, 829s:

DCmV, DCmV +ACmV, DC+ACmV +ACmV, Logic-Level \square Hz & Duty%

Press the **SELECT** button momentarily to select the subject functions in sequence. Last selection will be saved as power up default for repeat measurement convenience.

Models 827s, 822s, 821s:

DCmV, DCmV +ACmV, Logic-Level \square Hz & Duty%

Press the **SELECT** button momentarily to select the subject functions in sequence. Last selection will be saved as power up default for repeat measurement convenience.

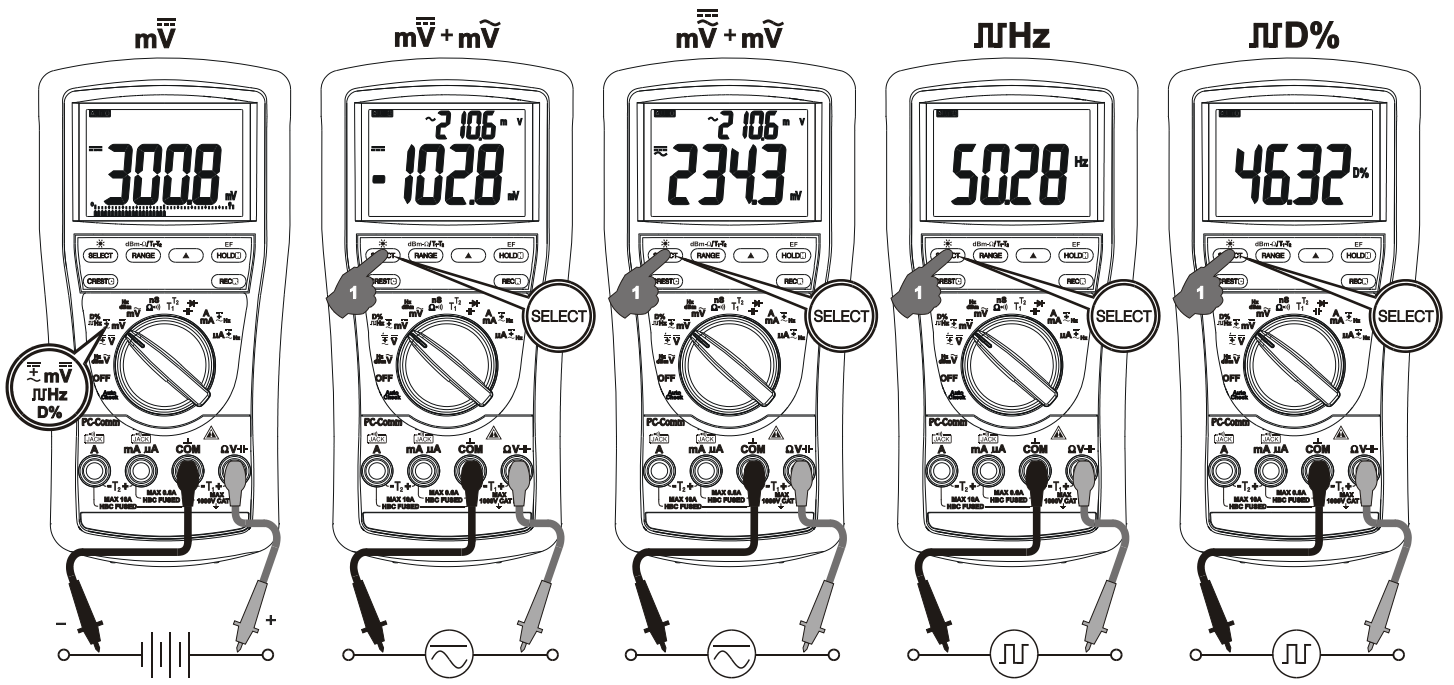

ACmV +Hz, dBm +Hz (Model 829s only), Hz +ACmV functions

Press the **SELECT** button momentarily to select the subject functions in sequence. Last selection will be saved as power up default for repeat measurement convenience.

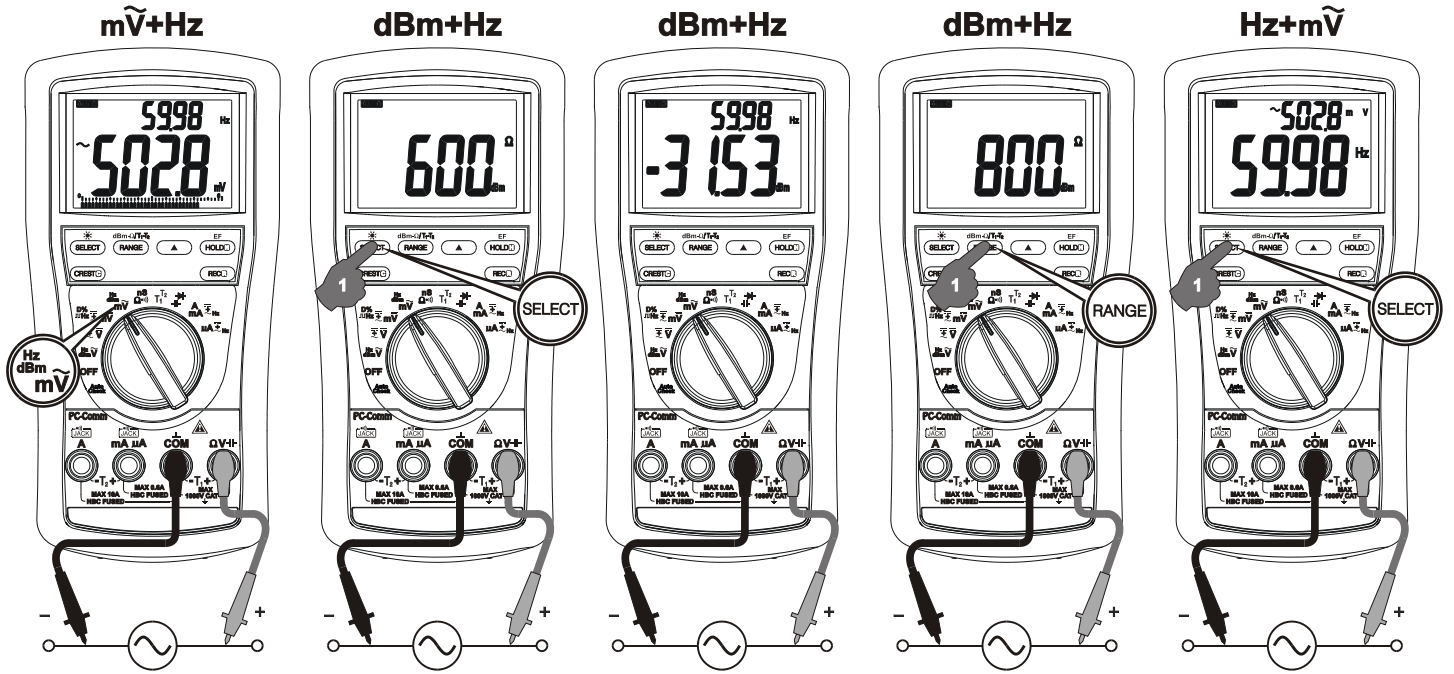

nS Conductance (Models **525s, 521s, 829s, 827s only**), Ω Resistance, $\bullet\bullet$) Continuity functions

Press the **SELECT** button momentarily to select the subject functions in sequence for models **525s, 521s, 829s and 827s**. Last selection will be saved as power up default for repeat measurement convenience. Direct rotary switch selection on Ω **Resistance** and $\bullet\bullet$) **Continuity** functions for models **822s and 821s**.

Note:

Conductance is the inverse of Resistance, that is $S=1/\Omega$ or $nS=1/G\Omega$. It virtually extends the Resistance measurements to the order of Giga-Ohms for leakage measurements.

$\bullet\bullet$) Continuity function is convenient for checking wiring connections and operation of switches. A continuous beep tone indicates a complete wire.

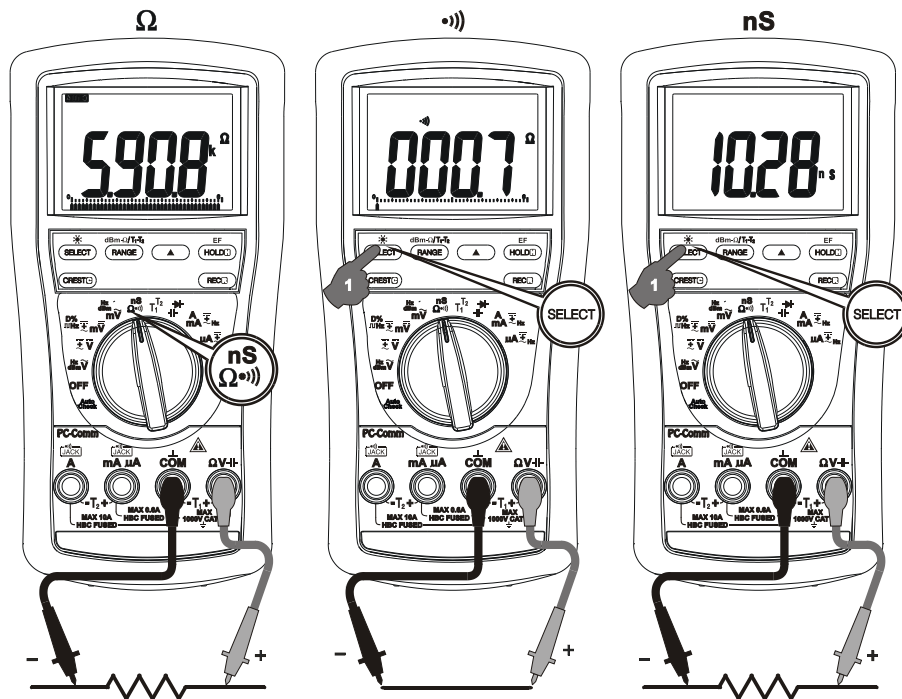

CAUTION

Using resistance and continuity function in a live circuit will produce false results and may damage the instrument. In many cases the suspected component must be disconnected from the circuit to obtain an accurate reading

Temperature functions (Models **525s, 521s, 829s, 827s only**)

Press **SELECT** button momentarily to toggle between $^{\circ}C$ and $^{\circ}F$ readings. For Dual Channel Temperature function models **829s & 525s**, press **T1-T2 (RANGE)** button momentarily can select **T1, T2, T1 +T2** or **T1-T2 +T2** readings. Last selection will be saved as power up default for repeat measurement convenience.

Note: Be sure to insert the banana plug type-K temperature bead probe Bkp60 with correct **+** **-** polarities. You can also use a plug adapter Bkb32 (Optional purchase) with banana pins to type-K socket to adapt other standard type-K mini plug temperature probes.

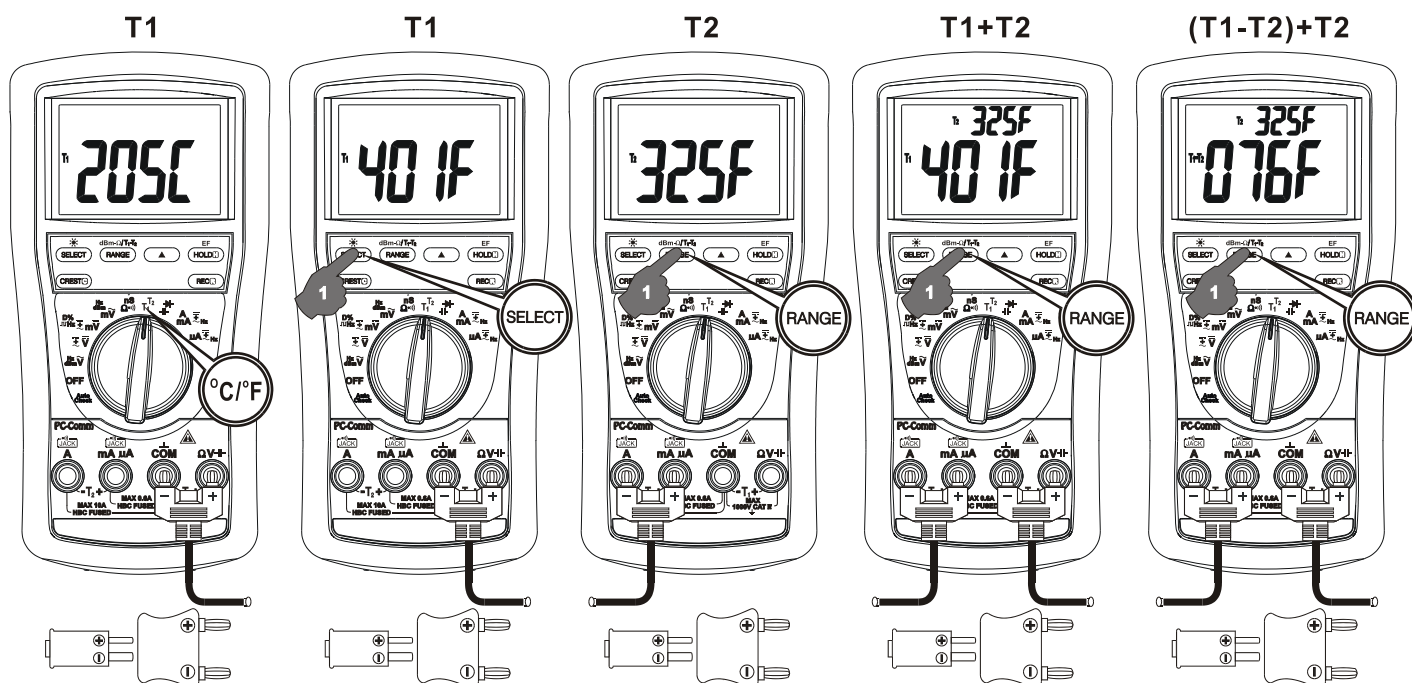

⚡ Capacitance, ⚡ Diode test functions

Press the **SELECT** button momentarily to select the subject functions in sequence. Last selection will be saved as power up default for repeat measurement convenience.

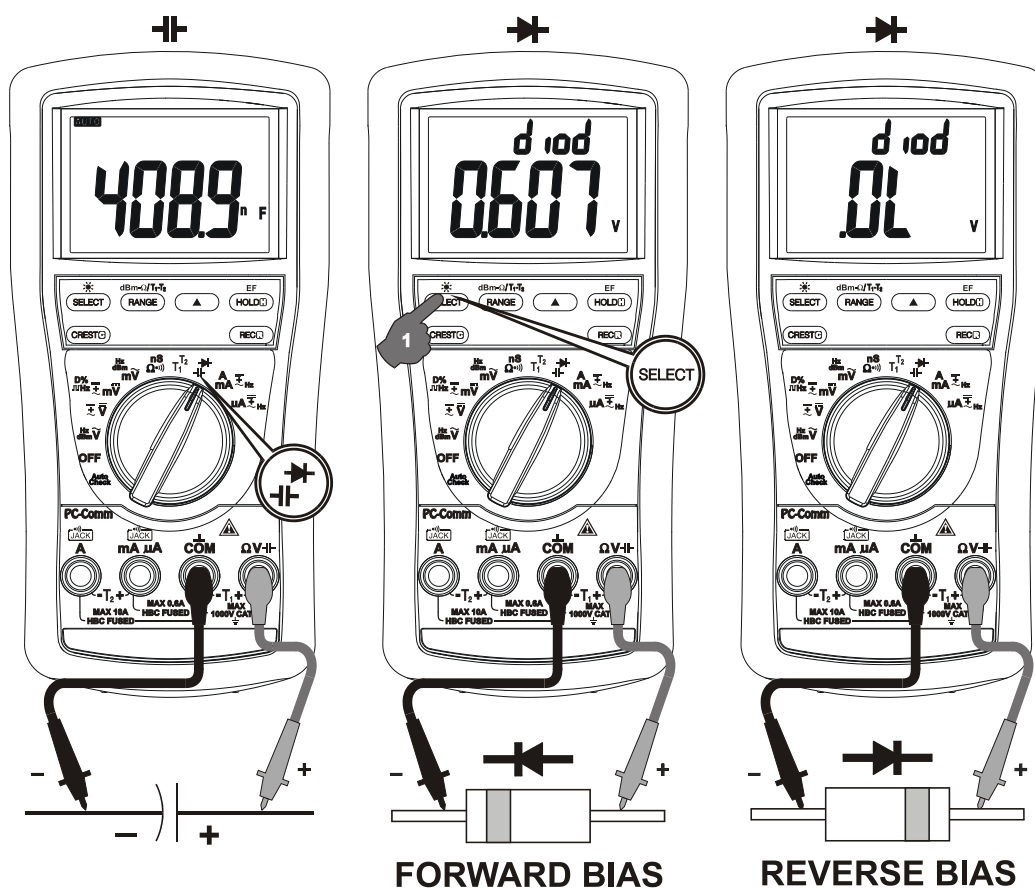

CAUTION

Discharge capacitors before making any measurement. Large value capacitors should be discharged through an appropriate resistance load.

Normal forward voltage drop (forward biased) for a good silicon diode is between 0.400V to 0.900V. A reading higher than that indicates a leaky diode (defective). A zero reading indicates a shorted diode (defective). An OL indicates an open diode (defective). Reverse the test leads connections (reverse biased) across the diode. The digital display shows OL if the diode is good. Any other readings indicate the diode is resistive or shorted (defective).

μ A, mA, and A Current functions

Press **SELECT** button momentarily to select **DC**, **DC +AC**, **DC+AC +AC** and **AC +Hz**. Last selection will be saved as power up default for repeat measurement convenience.

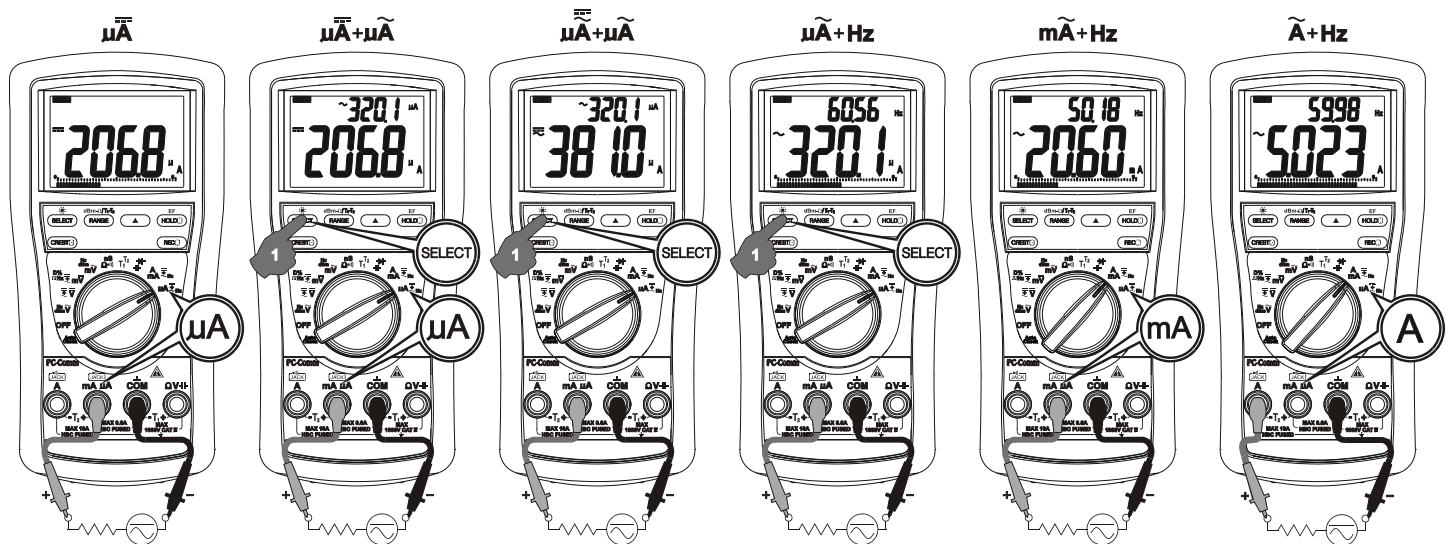

*Note: When measuring a 3-phase system, special attention should be taken to the phase-to-phase voltage which is significantly higher than the phase-to-earth voltage. To avoid exceeding the voltage rating of the protection fuse(s) accidentally, always consider the phase-to-phase voltage as the working voltage for the protection fuse(s).

Electric Field EF-Detection (Models 829s & 827s only)

At any function, press the **EF** button for one second or more to toggle to EF-Detection feature. The meter displays "E.F." when it is ready. Signal strength is indicated as a series of bar-graph segments on the display plus variable beep tones.

● **Non-Contact EF-Detection:** An antenna is located along the top of the meter, which detects electric field surrounds current-carrying conductors. It is ideal for tracing live wiring connections, locating wiring breakage and to distinguish between live or earth connections.

● **Probe-Contact EF-Detection:** For more precise indication of live wires, such as distinguishing between live and ground connections, use the Red (+) test probe for direct contact measurements.

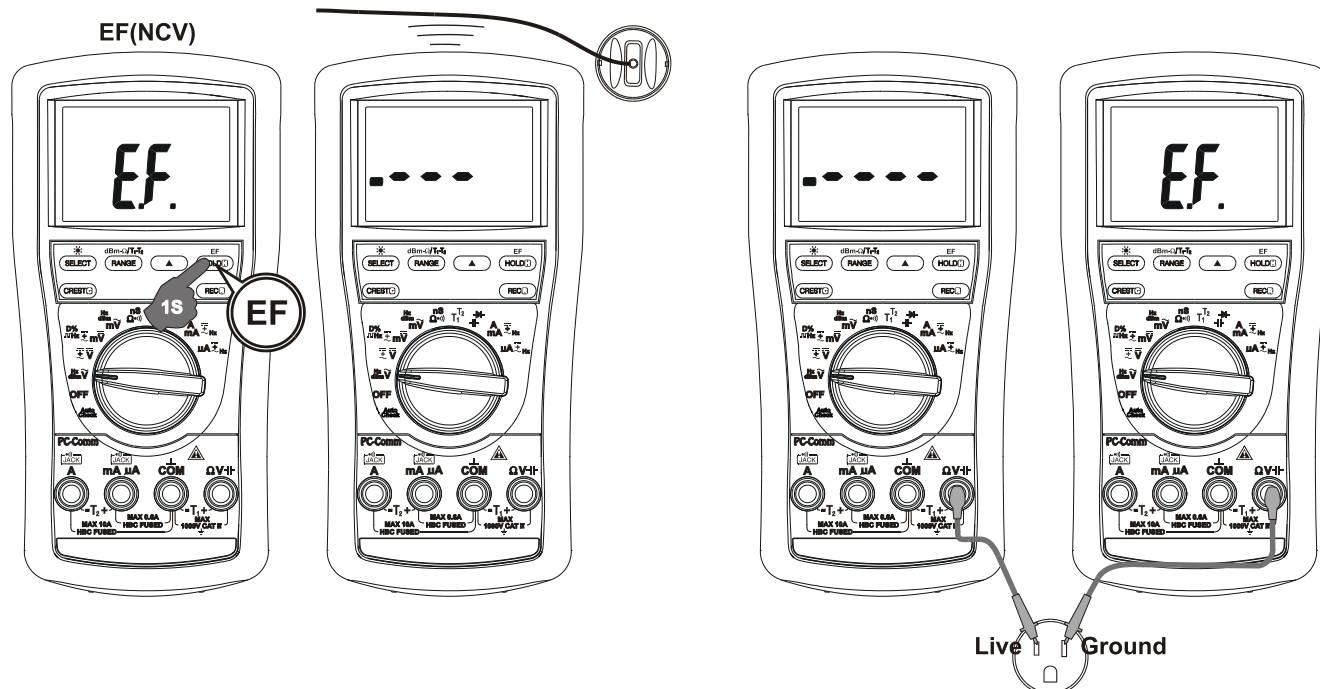

PC computer interface capabilities

The instrument equips with an optical isolated interface port at the meter back for data communication. Optional purchase PC USB interface kit BU-82X is required to connect the meter to the PC computer.

MAX/MIN/AVG* (REC) at fast 20/s measurement mode (Models 525s*, 521s*, 829s, 827s only)

Press **REC** button momentarily to activate MAX/MIN/AVG* recording mode. The LCD “R” & “MAX MIN AVG*” turn on, and the reading update rate will be increased to 20/second. The meter beeps when new MAX (maximum) or MIN (minimum) reading is updated. AVG* (Average) reading is calculated over time. Press the button momentarily to read the MAX, MIN, MAX-MIN and AVG* readings in sequence. Press the button for 1 second or more to exit MAX/MIN/AVG* recording mode. Auto-ranging remains, and Auto-Power-Off is disabled automatically in this mode. *AVG reading is not available to models 525s & 521s.

1ms CREST capture mode (Models 525s, 521s, 829s, 827s only)

Press **CREST** button momentarily to activate CREST (Instantaneous Peak-Hold) mode to capture voltage or current signal duration as short as 1ms. The LCD “C” & “MAX” turn on. The meter beeps when new MAX (maximum) or MIN (minimum) reading is updated. Press the button momentarily to read the MAX, MIN, and MAX-MIN (Vp-p) readings in sequence. Press the button for 1 second or more to exit CREST mode. Auto-ranging (up range) remains, and Auto-Power-Off is disabled automatically in this mode.

Backlight display (Models 525s, 521s, 829s only)

Press the **SELECT** button for 1 second or more to toggle the LCD backlight. The backlight will also be turned off automatically after 32 seconds to extend battery life.

Beep-Jack™ Input Warning

The meter beeps as well as displays “InEr” to warn the user against possible damage to the meter due to improper connections to the μ A, mA, or A input jacks when other function (like voltage function) is selected. **Beep-Jack™ Input Warning** is disabled while **Data Logging operation** (Models **525s & 521s** only) is activated.

Hold

The hold feature freezes the display for later view. Press the **HOLD** button momentarily to toggle the hold feature.

▲ Relative Zero mode

Relative zero allows the user to offset the meter consecutive measurements with the displaying reading as the reference value. Practically all displaying readings can be set as relative reference value including MAX/MIN/AVG* readings. Press the ▲ button momentarily to toggle relative zero mode.

Manual or Auto-ranging

Press the **RANGE** button momentarily to select manual-ranging, and the meter will remain in the range it was in, the LCD **AUTO** turns off. Press the button momentarily again to step through the ranges. Press and hold the button for 1 second or more to resume auto-ranging.

Note: Manual ranging feature is not available in Hz function.

Set Beeper Off

Press the **RANGE** button while turning the meter on to temporarily disable the Beeper feature. Turn the rotary switch OFF and then back on to resume.

Auto-Power-off (APO)





The Auto-Power-off (APO) mode turns the meter off automatically to extend battery life after approximately 30 minutes of no activities. Activities are specified as: 1) Rotary switch or push button operations, and 2) Significant measuring readings of above 512 counts or non-OL Ω readings. In other words, the meter will intelligently avoid entering the APO mode when it is under normal measurements.. To wake up the meter from APO, press the **SELECT, RANGE, RELATIVE or HOLD** button momentarily or turn the rotary switch OFF and then back on. Always turn the rotary switch to the OFF position when the meter is not in use

Disabling Auto-Power-off

Press the **SELECT** button while turning the meter on to temporarily disable the Auto-Power-Off feature. Turn the rotary switch OFF and then back on to resume.

Data Logging operation (Models **525s & 521s** only)

1) Set logging interval

● Press the  (Timer) button for 1 second or more to display the selected sampling speed in second. Factory default t0.05 means sampling speed is 0.05 second. Press the  (Up-arrow) or  (Down-arrow) button momentarily to select a different sampling speed from 0.05s (0.1s for single T1/T2, Diode & Ω/nS ; 0.5s for Hz/Duty; 2s for Cx & dual T1 +T2/T1-T2 +T2), 0.1s, 0.5s, 1s, 2s, 3s, 4s, 5s, 10s, 15s, 30s, 60s, 120s, 180s, 300s, up to the slowest 600s. Then press the  (Timer) button for 1 second or more to confirm the new setting. The setting resets to default when function is changed.

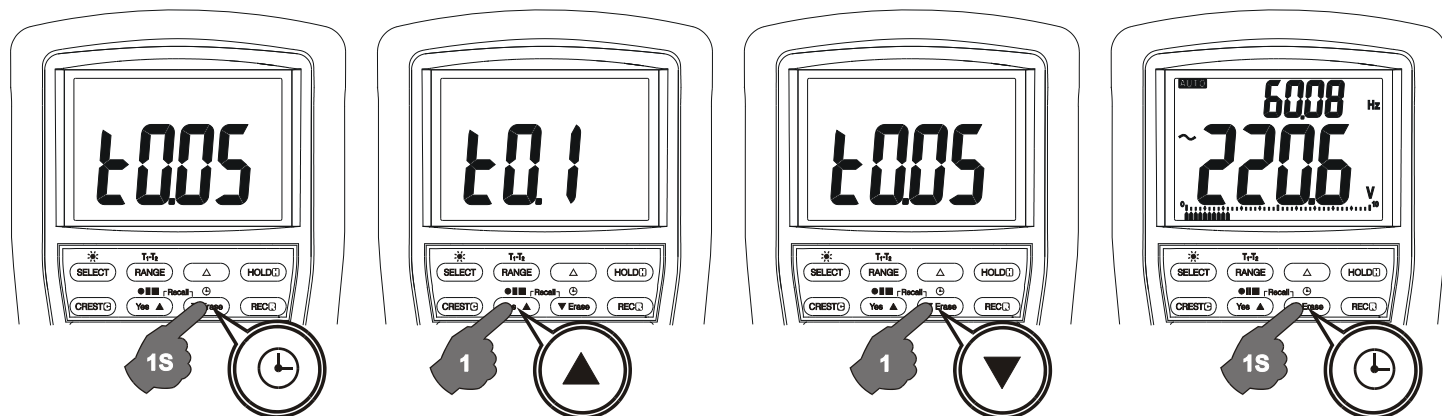

2) Start/Stop data-logging

Note: Set/view logging interval right before starting data-logging to avoid mis-handling. Data-logging function stops automatically to ensure logged-data accuracy when Low-battery indication turns on. Lo-bat symbol stays with the last logged data as a reminder.

● The meter supports multi-session data-logging. Multiple functions can be logged one-at-a-time into the meter free memory up to 999 separate session-pages without erasing the formerly logged one(s). Press the  (Start) button for 1 second or more to start the data-logging mode. “LEft” displays momentarily followed by a number (mini / main displays for most-significant / least-significant numbers separately) to indicate the memory points left for new logging session(s). Below example illustrates 43102 memory points is available for new logging session(s). Data-logging capability: 5400/10800 points for **model 521s** dual/single display; 43500/87000 points for **model 525s** dual/single display.

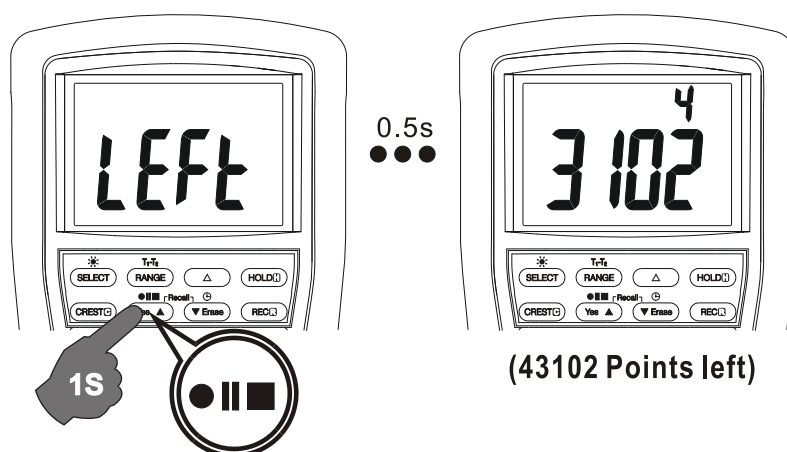

● Press the **Yes** button momentarily to confirm starting a new logging session directly without erasing the formerly logged one(s).

● Or you can press the **Erase** button momentarily to erase ALL of the formerly logged

session-page(s), and start a new logging session from the very first session-page (P.001) with maximum meter memory.

- The bar-graph turns to a swinging pointer when data-logging mode is running.

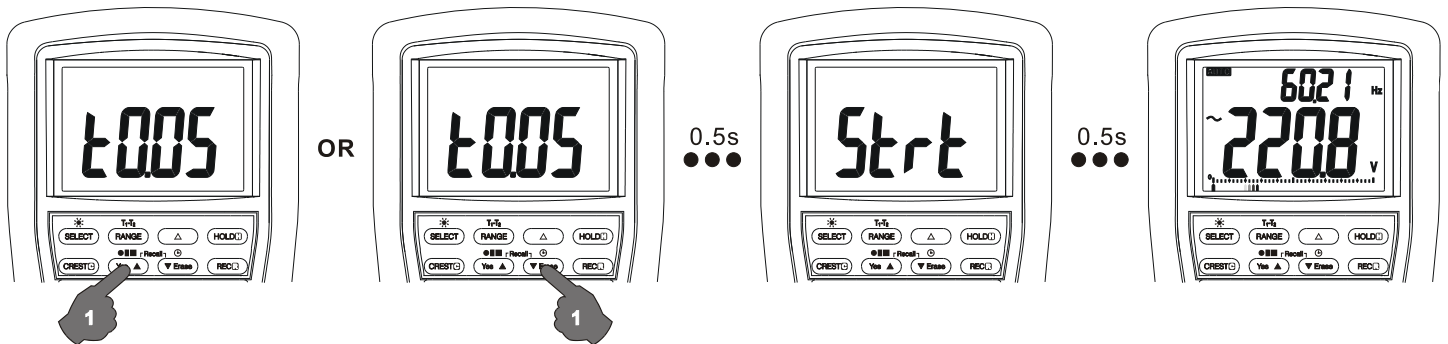

(Yes = No Erase & Start) (Erase = Erase ALL & Start)

- Press **SELECT** button momentarily to toggle the LCD display between measuring data and logged data item number (mini / main displays for most-significant / least-significant numbers separately).
- Press **● || ■** (PAUS/CONT/STOP) button momentarily to pause/continue logging.
- Press **● || ■** (PAUS/CONT/STOP) button for 1 second or more to stop logging.
- When a sampling speed of 30s or longer is selected, the meter will enter a 50% power down mode between data logging measurements (approx. 4.2 minutes after data logging is started) displaying only the swinging pointer. Press the SELECT button momentarily can resume real time display.

In case of low battery, the meter will stop logging automatically. For long-term logging, it is recommended to replace with a new battery before starting logging.

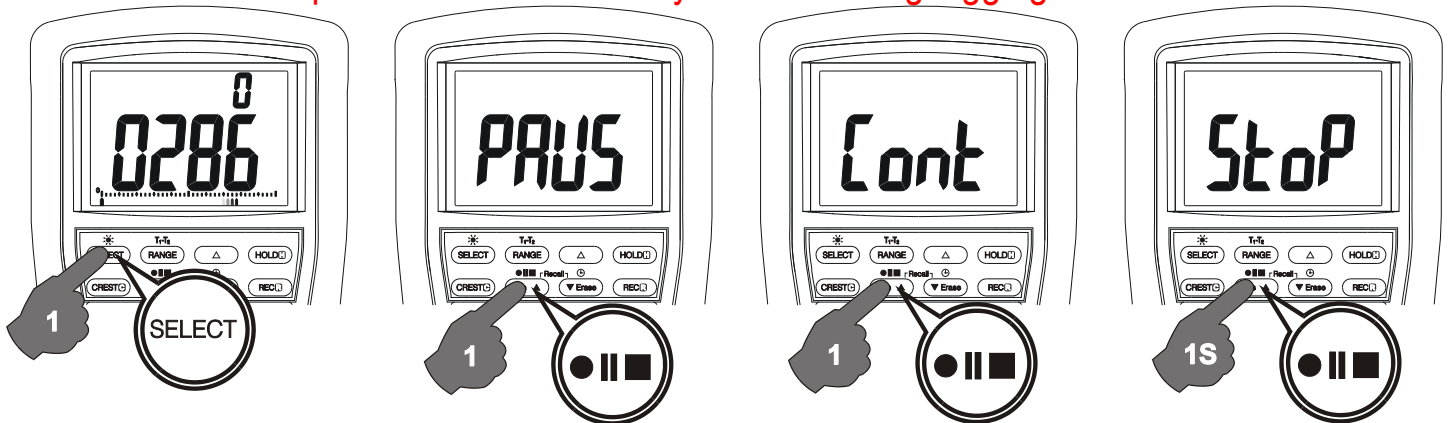

3) Recall logged data

- Press the **▲** (Up-arrow) and **▼** (Down-arrow) buttons simultaneously to enter the Recall mode. The last session-page number shows up for 0.5 second before displaying the last logged data item. "R" & "C" annunciators turn on.
- Press the **▲** (Up-arrow) or **▼** (Down-arrow) button momentarily to review the logged data one-at-a-time in sequence. Press and hold for 1 second and up for fast scrolling. The beeper sounds when the first or last data is reached.
- Press **SELECT** button momentarily to toggle the LCD display between logged data and its item number.
- Press the **▲** (Up-arrow) and **▼** (Down-arrow) buttons simultaneously again to select

another session-page in sequence. Press-and-hold for 1 second and up for fast scrolling, and the beeper sounds when the first or last page is reached.

- Turn Rotary switch to another function or OFF to exit the RECALL mode.

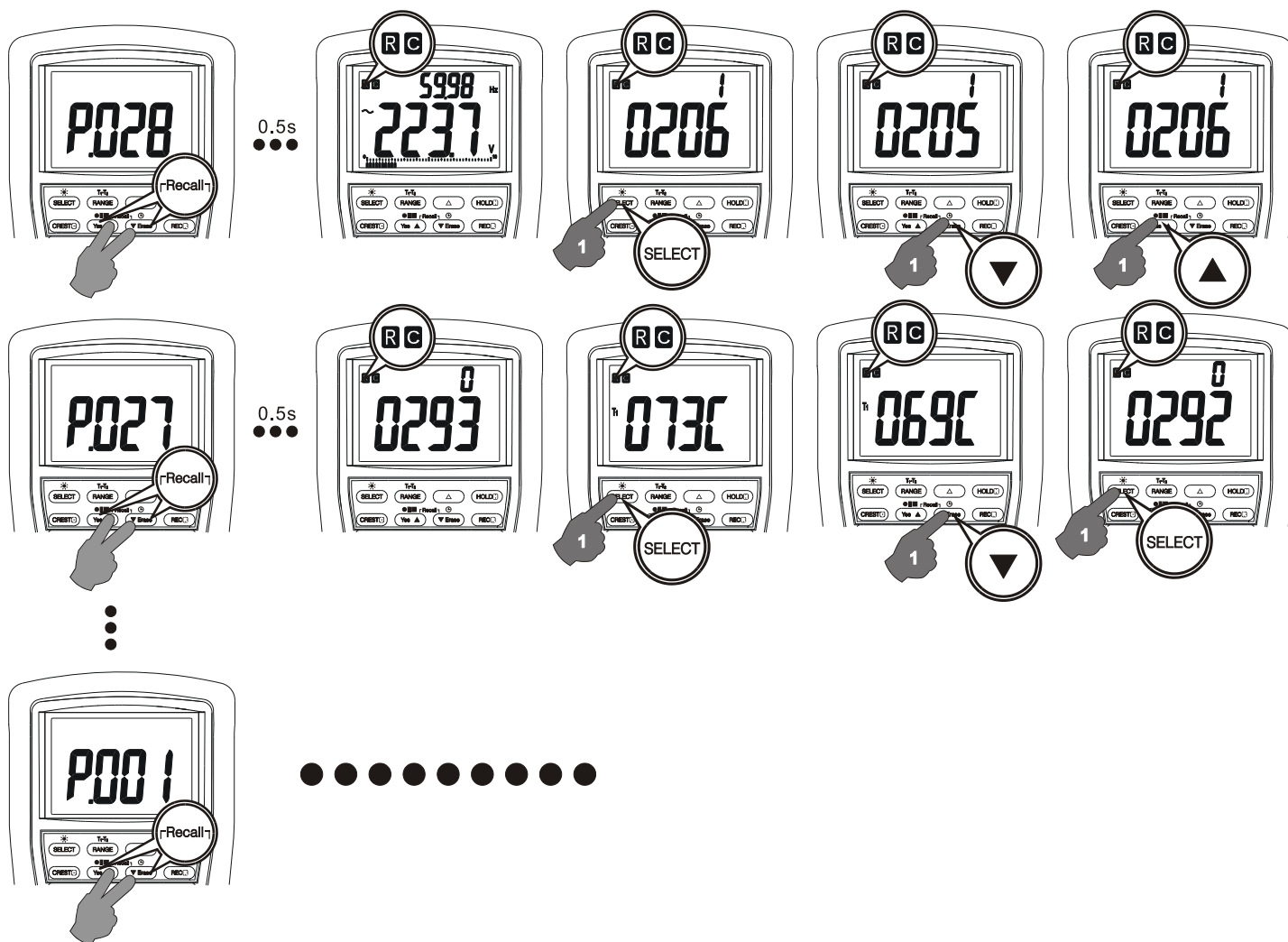

5) MAINTENANCE

WARNING

To avoid electrical shock, disconnect the meter from any circuit, remove the test leads from the input jacks and turn OFF the meter before opening the case. Do not operate with open case. Install only the same type of fuse or equivalent

Calibration

Periodic calibration at intervals of one year is recommended to maintain meter accuracy. Accuracy is specified for a period of one year after calibration.

If self-diagnostic message "rE-O" is being displayed while powering on, the meter is re-organizing internal parameters. Do not switch off the meter, and it will be back to normal measurement shortly. However, if self-diagnostic message "C_Er" is being displayed while powering on, some meter ranges might be largely out of specifications. To avoid misleading measurements, stop using the meter and send it for re-calibration. Refer to the LIMITED WARRANTY section for obtaining warranty or repairing service.

Cleaning and Storage

Periodically wipe the case with a damp cloth and mild detergent; do not use abrasives or solvents. If the meter is not to be used for periods of longer than 60 days, remove the battery and store it separately

Trouble Shooting

If the instrument fails to operate, check battery, fuses, leads, etc., and replace as necessary. Double check operating procedure as described in this user's manual

If the instrument voltage-resistance input terminal has subjected to high voltage transient (caused by lightning or switching surge to the system) by accident or abnormal conditions of operation, the series fusible resistors will be blown off (become high impedance) like fuses to protect the user and the instrument. Most measuring functions through this terminal will then be open circuit. The series fusible resistors and the spark gaps should then be replaced by qualified technician. Refer to the LIMITED WARRANTY section for obtaining warranty or repairing service.

Battery and Fuse replacement

Battery use: Single 9V battery; NEDA1604G, JIS006P IEC6F22, NEDA1604A, JIS6AM6 or IEC6LF22

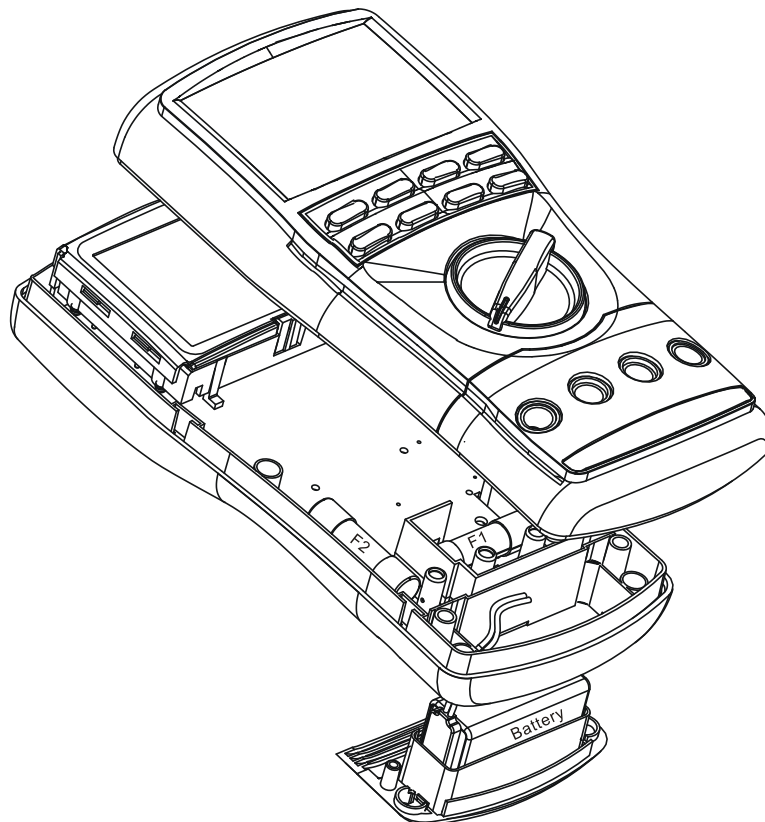

Fuses use:

Fuse (FS1) for μ mA current input:

0.44A/1000Vac & Vdc, IR 10kA or better, F fuse; Dimension: 10 x 38 mm

Fuse (FS2) for A current input:

11A/1000Vac & Vdc, IR 20kA or better, F fuse; Dimension: 10 x 38 mm

Battery replacement:

Loosen the 2 screws from the battery access door of the case bottom. Lift the battery access door and thus the battery compartment up. Replace the battery. Re-fasten the screws.

Fuse replacement:

Loosen the 4 screws from the case bottom. Lift the end of the case bottom nearest the input jacks until it unsnaps from the case top. Replace the blown fuse(s). Replace the case bottom, and ensure that all the gaskets are properly seated and the two snaps on the case top (near the LCD side) are engaged. Re-fasten the screws.

GENERAL SPECIFICATIONS

Display:

9999 counts: ACV, DCV, Hz & nS

6000 counts: mV, μ A, mA, A, Ohm & Capacitance

Polarity: Automatic

Update Rate:

Digital Display: 5 per second nominal;

41 Segments Bar-graph: 60 per second max

Low Battery: Below approx. 7V

Operating Temperature: 0°C to 45°C

Relative Humidity: Maximum relative humidity 80% for temperature up to 31°C decreasing linearly to 50% relative humidity at 45°C

Pollution degree: 2

Storage Temperature: -20°C to 60°C, < 80% R.H. (with battery removed)

Altitude: Operating below 2000m

Temperature Coefficient: nominal 0.15 x (specified accuracy)/ °C @ (0°C ~ 18°C or 28°C ~ 45°C), or otherwise specified

Sensing:

Models 829s, 521s & 525s: AC+DC True RMS

Models 827s & 822s: AC True RMS

Model 821s: Average Sensing

Safety: Double insulation per IEC/UL/EN61010-1 Ed. 3.0, IEC/EN61010-2-030 Ed. 1.0, IEC/EN61010-2-033 Ed. 1.0, IEC/UL/EN61010-031 Ed. 1.1 and CAN/CSA-C22.2 No. 61010-1-12 Ed. 3.0 to Category IV 1000Vac & Vdc.

Transient protection: 12kV (1.2/50 μ s surge)

Terminals (to COM) Measurement Category:

V / A / mA μ A : Category IV 1000Vac & Vdc

Overload Protections:

μA & mA : 0.44A/1000V DC/AC rms, IR 10kA, F fuse
 A : 11A/1000V DC/AC rms, IR 20kA, F fuse
 V : 1100V DC/AC rms
 mV, Ω & Others : 1000V DC/AC rms

E.M.C. : Meets EN61326-1:2006 (EN55022, EN61000-3-2, EN61000-3-3, EN61000-4-2, EN61000-4-3, EN61000-4-4, , EN61000-4-5, EN61000-4-6, EN61000-4-8, EN61000-4-11)

In an RF field of 3V/m:

Capacitance function is not specified

Other function ranges:

Total Accuracy = Specified Accuracy + 100 digits

Performance above 3V/m is not specified

Power Supply: Single 9V battery; NEDA1604G, JIS006P IEC6F22, NEDA1604A, JIS6AM6 or IEC6LF22

Power Consumption: 5 mA typical

APO Timing: Idle for 30 minutes

APO Consumption: 50 μA typical

Dimension: L208mm X W103mm X H64.5mm with holster

Weight: 635 gm with holster

Accessories: Test lead pair; battery installed; user's manual; BKP60 banana plug type-K thermocouple (Models 829s, 827s, 521s & 525s only)

Optional purchase accessories: USB interface kit BU-86X; BKB32 banana plug to type-K socket plug adaptor

Electrical Specifications

Accuracy is \pm (% reading digits + number of digits) or otherwise specified, at 23°C \pm 5°C & less than 75% relative humidity.

True RMS voltage & current accuracies are specified from 10 % to 100 % of range or otherwise specified. Maximum Crest Factor < 2:1 at full scale & < 4:1 at half scale, and with frequency components within the specified frequency bandwidth for non-sinusoidal waveforms.

DC Voltage

Function	RANGE	Accuracy
mV	60.00mV	0.12%+2d
	600.0mV	0.06%+2d
V	9.999V, 99.99V, 999.9V	0.08%+2d

Input Impedance: 10M Ω , 50pF nominal
(80pF nominal for 600mV range)

AC Voltage

Function	RANGE	Accuracy
50Hz ~ 60Hz		
mV	60.00mV, 600.0mV	0.5% + 3d
V	9.999V, 99.99V, 999.9V	
40Hz ~ 500Hz		
mV	60.00mV, 600.0mV	0.8% + 4d
V	9.999V, 99.99V	1.0%+4d
	999.9V	2.0%+4d
500Hz ~ 1kHz		
mV	60.00mV, 600.0mV	2.0% + 3d
V	9.999V, 99.99V	1.0%+4d
	999.9V	2.0%+4d
1kHz ~ 3kHz		
mV	60.00mV, 600.0mV	2.0%+3d
V	9.999V, 99.99V, 999.9V	3.0%+4d
	3kHz ~ 20kHz	
mV	60.00mV ¹⁾ , 600.0mV ¹⁾	2%+3d
V	9.999V ²⁾ , 99.99V	3dB
	999.9V	Unspec'd

¹⁾Specified from 30% to 100% of range.

²⁾for 3kHz ~ 15kHz only

Input Impedance: 10M Ω , 50pF nominal
(80pF nominal for mV ranges)

dBm

At 600 Ω , -11.76dBm to 54.25dBm,
Accuracy: ± 0.25 dB + 2d (@40Hz -- 20kHz)

Input Impedance: 10M Ω , 50pF nominal
Selectable reference impedance of 4, 8,
16, 32, 50, 75, 93, 110, 125, 135, 150, 200,
250, 300, 500, 600, 800, 900, 1000, 1200 Ω

AutoCheck™ (DCV)

RANGE	Accuracy
9.999V, 99.99V, 999.9V	0.5%+3d

Lo-Z DCV Threshold:

> +1.5VDC or < -1.0VDC nominal

Lo-Z DCV Input Impedance:

Initially approx. 3.0k Ω , 165pF nominal;
Impedance increases abruptly within a
fraction of a second as display voltage is
above 50V (typical). Ended up
impedances vs display voltages typically
are:

18k Ω @100V

125k Ω @ 300V

320k Ω @ 600V

500k Ω @ 1000V

DC^{AC} & AC+DC^{AC} Voltage¹⁾

Function	RANGE	Accuracy
DC, 50Hz ~ 60Hz		
mV	60.00mV, 600.0mV	0.7% + 6d
V	9.999V, 99.99V, 999.9V	
40Hz ~ 1kHz		
mV	60.00mV, 600.0mV	1.0%+6d
V	9.999V, 99.99V, 999.9V	2.2%+6d
	1kHz ~ 20kHz	
mV	60.00mV ²⁾ , 600.0mV ²⁾	2.2%+6d
V	9.999V ³⁾ , 99.99V	3dB
	999.9V	Unspec'd

¹⁾Specified from 10% to 100% of range for
Model 821

²⁾Specified from 30% to 100% of range.

³⁾for 1kHz ~ 15kHz only

Input Impedance: 10M Ω , 50pF nominal
(80pF nominal for mV ranges)

AutoCheck™ (ACV)

RANGE	Accuracy
50Hz ~ 60Hz	
9.999V, 99.99V, 999.9V	1.0%+4d

Lo-Z ACV Threshold:

> 3VAC (50/60Hz) nominal

Lo-Z ACV Input Impedance:

Initially approx. 3.0k Ω , 150pF nominal;
Impedance increases abruptly within a
fraction of a second as display voltage is
above 50V (typical). Ended up
impedances vs display voltages typically
are:

18k Ω @100V

125k Ω @ 300V

320k Ω @ 600V

460k Ω @ 1000V

Ohms

RANGE	Accuracy
600.0 Ω , 6.000k Ω , 60.00k Ω , 600.0k Ω	0.1%+3d
6.000M Ω	0.4%+3d
60.00M Ω	1.5%+5d
99.99nS	0.8%+10d

Open Circuit Voltage: < 1.2VDC (< 1.0VDC
for 60M Ω range)

AutoCheck™ (Ohms)

RANGE	Accuracy
600.0 Ω , 6.000k Ω , 60.00k Ω , 600.0k Ω	0.5%+4d
6.000M Ω	0.8%+3d
60.00M Ω ¹⁾	2.0%+5d

¹⁾Temperature Coefficient: 0.6 x (specified
accuracy)/ °C @(0°C ~ 18°C or 28°C ~ 45°C)

Open Circuit Voltage: < 1.2VDC (<
1.0VDC for 60M Ω range)

Audible Continuity Tester

Audible threshold: between 20 Ω and 300 Ω ;
Response time < 100 μ s

Capacitance

RANGE	Accuracy ¹⁾
60.00nF, 600.0nF	0.8% + 3d
6.000 μ F	1.0% + 3d
60.00 μ F	2.0% + 3d
600.0 μ F ²⁾	3.5% + 5d
6.000mF ²⁾	5.0% + 5d
25.00mF ²⁾	6.5% + 5d

¹⁾Accuracies with film capacitor or better

²⁾In manual-ranging mode, measurements
not specified below 50.0 μ F, 0.54mF and
5.4mF for 600.0 μ F, 6.000mF and 25.00mF
ranges respectively

AC & AC+DC Current

RANGE	Accuracy	Burden voltage
50Hz ~ 60Hz		
600.0 μ A, 6000 μ A	0.6%+3d	0.08mV/ μ A
60.00mA		2.1mV/mA
600.0mA	1.0%+3d	
6.000A, 10.00A ¹⁾	0.8%+6d	0.02V/A
40Hz ~ 1kHz		
600.0 μ A, 6000 μ A	0.8%+4d	0.08mV/ μ A
60.00mA		2.1mV/mA
600.0mA	1.0%+4d	
6.000A, 10.00A ¹⁾	0.8%+6d	0.02V/A

¹⁾10A continuous, >10A to 20A for 30
second max with 5 minutes cool down

interval

DC Current

RANGE	Accuracy	Burden voltage
600.0 μ A, 6000 μ A	0.2%+4d	0.08mV/ μ A
60.00mA, 600.0mA		2.1mV/mA
6.000A, 10.00A ¹⁾		0.02V/A

¹⁾10A continuous, >10A to **20A** for 30 second max with 5 minutes cool down interval

Line Level Frequency (~Hz)

Function Range	Frequency	Sensitivity (Sine RMS)
AC 60.00mV	15.00 ~ 50.00kHz	40mV
AC 600.0mV		60mV
AC 9.999V	15.00 ~ 10.00kHz	2.5V
AC 99.99V		25V
AC 999.9V		100V
AC 600.0 μ A	15.00 ~ 3.000kHz	200 μ A
AC 6000 μ A		600 μ A
AC 60.00mA		40mA
AC 600.0mA		60mA
AC 6.000A		4A
AC 10.00A		6A

Accuracy: 0.04%+4d

Logic Level Frequency (□Hz) & Duty Cycle (D%)

@ DCmV Function	Range	Accuracy ¹⁾
Frequency	5.00Hz ~ 1.000MHz	0.04%+4d
Duty Cycle	0.00% ~ 100.0%	3d/kHz+2d ²⁾

¹⁾Sensitivity: 2.5Vp (Square wave) for 3V & 5V Logic Family

2) Specified Frequency: 5Hz ~ 10kHz

Non-Contact EF-Detection

Typical Voltage	Bar Graph Indication
20V (tolerance:10V~36V)	-
55V (tolerance: 23V ~ 83V)	--
110V (tolerance: 59V ~ 165V)	---
220V (tolerance: 124V ~ 330V)	----
440V (tolerance: > 250V)	-----

Indication: Bar graph segments & audible beep tones proportional to the field strength

Detection Frequency: 50/60Hz

Detection Antenna: Top end of the meter

Probe-Contact EF-Detection:

For more precise indication of live wires, such as distinguishing between live and ground connections, use the Red (+) test probe for direct contact measurements.

Crest mode (Instantaneous Peak Hold)

Accuracy: Specified accuracy adds 250 digits for changes > 1.0 ms in duration

Record mode

Accuracy: Specified accuracy adds 10 digits for changes > 100 ms in duration

Diode Tester

RANGE	Accuracy
2.000V	1.0%+1d

Test Current (Typically): 0.4mA

Open Circuit Voltage: < 3.5 VDC

Temperature

RANGE	Accuracy
-50°C to 1000°C	0.3%+2°C
-58°F to 1832°F	0.3%+5°F

Type-K thermocouple range & accuracy not included

LIMITED WARRANTY

BRYMEN warrants to the original product purchaser that each product it manufactures will be free from defects in material and workmanship under normal use and service within a period of one year from the date of purchase. BRYMEN's warranty does not apply to accessories, fuses, fusible resistors, spark gaps, batteries or any product which, in BRYMEN's opinion, has been misused, altered, neglected, or damaged by accident or abnormal conditions of operation or handling.

To obtain warranty service, contact your nearest BRYMEN authorized agent or send the product, with proof of purchase and description of the difficulty, postage and insurance prepaid, to BRYMEN TECHNOLOGY CORPORATION. BRYMEN assumes no risk for damage in transit. BRYMEN will, at its option, repair or replace the defective product free of charge. However, if BRYMEN determines that the failure was caused by misused, altered, neglected, or damaged by accident or abnormal conditions of operation or handling, you will be billed for the repair.

THIS WARRANTY IS EXCLUSIVE AND IS IN LIEU OF ALL OTHER WARRANTIES, EXPRESSED OR IMPLIED, INCLUDING BUT NOT LIMITED TO ANY IMPLIED WARRANTY OR MERCHANTABILITY OR FITNESS FOR A PARTICULAR PURPOSE OR USE. BRYMEN WILL NOT BE LIABLE FOR ANY SPECIAL, INDIRECT, INCIDENTAL OR CONSEQUENTIAL DAMAGES.



BRYMEN TECHNOLOGY CORPORATION

TEL:+886 2 2226 3396

FAX:+886 2 2225 0025

<http://www.brymen.com>



PRINTED ON RECYCLABLE PAPER, PLEASE RECYCLE

COPYRIGHT © MMXIII BTC,

ALL RIGHTS RESERVED

P/N: 7M1C-1301-0000

PRINTED IN TAIWAN